

M&P[®]

by **Smith & Wesson[®]**

Safety & Instruction Manual



M&P[®] 22 COMPACT



Read the instructions and warnings in this manual CAREFULLY BEFORE using this firearm.

2100 Roosevelt Avenue • Springfield, MA 01104
1-800-331-0852 • Fax: 413-747-3317
www.smith-wesson.com

Copyright © 2016 Smith & Wesson Corp.
All rights reserved.



WARNING:



**READ THESE INSTRUCTIONS
AND WARNINGS CAREFULLY.**

**BE SURE YOU UNDERSTAND THESE
INSTRUCTIONS AND WARNINGS BEFORE
USING THIS FIREARM. FAILURE TO READ
THESE INSTRUCTIONS AND TO FOLLOW
THESE WARNINGS MAY RESULT IN SERI-
OUS INJURY OR DEATH TO YOU AND
OTHERS AND DAMAGE TO PROPERTY.**

**This SAFETY & INSTRUCTION MANUAL
should always accompany this firearm
and be transferred with it upon change
of ownership or when presented to
another person. A copy of the SAFETY &
INSTRUCTION MANUAL is available
FREE via download at
www.smith-wesson.com
or upon request from:**

SMITH & WESSON® CUSTOMER SUPPORT CENTER

**2100 ROOSEVELT AVENUE
SPRINGFIELD, MA 01104
TEL.: 1-800-331-0852, ext. 4125
E-mail: qa@smith-wesson.com**

TABLE OF CONTENTS

YOUR SAFETY RESPONSIBILITIES.....	3-6
SAFE STORAGE AND TRANSPORTATION	7-8
AMMUNITION	9-10
MODEL AND FEATURES IDENTIFICATION	11
INSPECTING YOUR PISTOL.....	12-13
MANUAL THUMB SAFETY	14
INTERNAL LOCK.....	15
MAGAZINE SAFETY	16
LOADED CHAMBER INDICATOR	16
PREPARATION FOR FIRING.....	17
LOADING	18-20
FIRING	20-21
CLEARING MISFIRES	21-22
UNLOADING.....	23
SIGHT ADJUSTMENT.....	24
FIELD STRIPPING / DISASSEMBLY.....	25-27
LUBRICATION	27
FIELD STRIPPING ASSEMBLY.....	28-30
MAGAZINE.....	31-32
CLEANING AND MAINTENANCE.....	35-37
LIMITED WARRANTY	37-38
CONTACT AND SHIPPING INFORMATION.....	39-40
CUSTOM SERVICE.....	41
BATTERY WARNINGS	43
PATENT INFORMATION AND WARRANTY CENTERS.....	44

YOUR SAFETY RESPONSIBILITIES

SAFETY IS YOUR NUMBER ONE RESPONSIBILITY!!!!

- At home, in the field, at the range, or anywhere, the first concern of every firearm owner should be safety. Apply the following safety rules in every situation, with any kind of firearm. If you feel uncertain about any operational aspects of your firearm, please contact Smith & Wesson at 1-800-331-0852, ext. 4125 before proceeding with its operation.
- If you are unfamiliar with firearms you should seek formal training before using your pistol.



WARNING: YOU MUST FOLLOW ALL OF THESE SAFETY RULES TO ENSURE THE SAFE USE OF YOUR FIREARM. THE FAILURE TO FOLLOW THE INSTRUCTIONS AND WARNINGS IN THIS MANUAL COULD CAUSE SERIOUS PERSONAL INJURY OR DEATH TO YOU OR OTHERS AND DAMAGE TO PROPERTY.

- As a firearm owner, you accept a demanding responsibility. How seriously you take this responsibility can be the difference between life and death. There is no excuse for careless or abusive handling of your firearm. At all times handle your firearm with intense respect for its power and potential danger.

YOUR SAFETY RESPONSIBILITIES CONTINUED

- **ALWAYS KEEP YOUR FIREARM POINTED IN A SAFE DIRECTION.** Never point a firearm at anyone or anything you do not intend to shoot whether or not it is loaded. This is particularly important when loading, unloading, or field stripping the gun. ALWAYS control the direction of the firearm.
- **ALWAYS TREAT EVERY FIREARM AS IF IT IS LOADED AND WILL FIRE.** Do not take anyone's word that the firearm is unloaded – always check for yourself. Never pass your firearm to another person until the cylinder or action is open and you visually check that it is unloaded. Keep your firearm unloaded and safely stored when not in use.
- **NEVER PLACE YOUR FINGER INSIDE THE TRIGGER GUARD OR ON THE TRIGGER UNLESS YOU INTEND TO FIRE.** Ensure that other objects do not touch the trigger.
- **ALWAYS BE SURE OF YOUR TARGET AND WHAT IS BEYOND IT.** Always be sure of where the bullet will strike and shoot only where there is a safe back stop free of obstructions, water or other surfaces which can cause ricochets. Be sure your bullet will stop behind your target. Bullets can glance off many surfaces like rocks or the surface of water and travel in unpredictable directions with considerable velocity. Do not fire randomly into the sky.
- **NEVER CROSS OBSTACLES SUCH AS FENCES OR STREAMS WITH A LOADED FIREARM.** Always make certain your firearm is unloaded before crossing a fence, climbing a tree, jumping a ditch or negotiating other obstacles.
- **SAFE GUN HANDLING IS YOUR PERSONAL RESPONSIBILITY AT ALL TIMES.** Firearms can be dangerous and can cause serious injury or death if they are misused or used inappropriately. Safety must be the prime consideration of any one who owns or handles firearms. Accidents are the result of violating the rules of safe gun handling and common sense. Firearm safety training is available. Contact your firearms dealer, law enforcement agency, local sportsman's club, the NRA, etc. for availability.
- **YOU ARE RESPONSIBLE FOR THE FIREARM AT ALL TIMES.** In owning a firearm, you must undertake full-time responsibility for your firearm's safety and security. You must protect yourself and all others against injury or death from misuse of the firearm 24 hours a day.
- **FIREARM SECURITY IS YOUR RESPONSIBILITY.** You must secure firearms safely from children and/or unauthorized users. Your firearm should always be kept unloaded and locked when not in use. A lock has been provided for this purpose. Never assume that the use of a lock is sufficient to safely secure your firearm. You must always evaluate your personal situation and employ the security systems that meet your needs and prevent children and unauthorized users from gaining access to your firearm.

YOUR SAFETY RESPONSIBILITIES CONTINUED

- **APPROPRIATE USE FOR YOUR FIREARM MEANS USING YOUR FIREARM FOR LEGAL PURPOSES.** For example - target shooting, hunting and lawful resistance of deadly criminal force. It is your responsibility to ensure that you are in compliance with all applicable laws and ordinances regarding the use of your firearm.
- **NEVER RELY ON MECHANICAL FEATURES ALONE.** Only your safe gun-handling habits will ensure the safe use of your firearm. This is your responsibility.
- **ALWAYS SAFELY STORE AND SECURE YOUR FIREARM.** Safe and secure storage of your firearm is one of your most important responsibilities. It is a full-time responsibility. You must always secure your firearm and ammunition separately so that they are not accessible to children and/or other unauthorized persons.
- **NEVER KEEP AMMUNITION IN THE SAME LOCATION AS THE FIREARM.** Store each in a separate and secure place.
- **ALWAYS WEAR EYE PROTECTION THAT IS SPECIFIED FOR USE WITH FIREARMS** every time you handle your firearm for cleaning and maintenance.
- **ALWAYS WEAR EYE AND HEARING PROTECTION THAT ARE SPECIFIED FOR USE WITH FIREARMS** every time you discharge your firearm. Make sure others in the vicinity of where you will be shooting do so as well.
- **NEVER USE ALCOHOL OR DRUGS BEFORE OR WHILE SHOOTING.** Do not use your firearm if you are on any medication which impairs, even slightly, your mental or physical ability.
- **ALWAYS HAVE ADEQUATE VENTILATION.** Discharging firearms in poorly ventilated areas, cleaning firearms, or handling ammunition may result in exposure to lead and other substances known to cause birth defects, reproductive harm, and other serious physical injury. Review the warnings and labels for all ammunition and cleaning products carefully. Wash hands thoroughly after exposure.
- **BEFORE HANDLING ANY FIREARM, UNDERSTAND ITS OPERATION.** Not all firearms are the same. Familiarize yourself with the mechanical features of any firearm you intend to use. If you feel uncertain about any operational aspects of your firearm, please contact Smith & Wesson at 1-800-331-0852, ext. 4125 before proceeding with its operation.
- **NEVER ALLOW A FIREARM TO BE USED BY INDIVIDUALS WHO DO NOT UNDERSTAND ITS SAFE OPERATION OR HAVE NOT READ THESE FIREARM SAFETY RULES.**

YOUR SAFETY RESPONSIBILITIES CONTINUED

- **ALWAYS USE THE CORRECT AMMUNITION FOR YOUR PARTICULAR FIREARM** as indicated by the marking on the firearm. Never use non-standard, reloaded, or “handloaded” ammunition which has not been subjected to internal ballistic pressure testing.
- **BEWARE OF BARREL OBSTRUCTIONS** Be sure the barrel is clear of obstructions before shooting. Mud, water, snow or other objects may inadvertently lodge in the barrel bore. A small obstruction can cause a dangerous increase in pressure and may damage your gun and cause injury to yourself and others.
- **BE SURE ALL ACCESSORIES, SUCH AS HOLSTERS, GRIPS, SLINGS, SCOPES AND OTHER ACCESSORIES ARE COMPATIBLE** with the firearm and that the accessories do not interfere with safe operation. It is your responsibility to understand and follow all of the instructions in this manual, as well as those which may be supplied with your ammunition and any accessory.
- **NEVER DISASSEMBLE YOUR FIREARM** beyond the field stripping procedure outlined in this manual. Improper disassembly or reassembly of your firearm may be dangerous and can lead to serious injury or death.
- **NEVER MANIPULATE, ADJUST OR CHANGE ANY OF THE INTERNAL COMPONENTS OF YOUR FIREARM UNLESS SPECIFICALLY INSTRUCTED TO DO SO IN THIS MANUAL.** Improper manipulation of any other internal component may affect the safety and reliability of your firearm and may cause serious injury or death.
- **NEVER ALLOW ANY ALTERATION OR REPLACEMENT OF PARTS IN YOUR SMITH & WESSON FIREARM UNLESS PERFORMED BY A QUALIFIED GUNSMITH** using genuine factory supplied parts. If you do otherwise, improper functioning of your firearm may occur and serious injury or death and damage to property may result.



WARNING: SAFE USE OF A FIREARM IS YOUR PERSONAL RESPONSIBILITY AND THE FAILURE TO FOLLOW ALL OF THESE BASIC SAFETY RULES MAY RESULT IN SEVERE PERSONAL INJURY OR DEATH TO YOU OR OTHERS AND DAMAGE TO PROPERTY. YOU ARE THE MOST IMPORTANT SAFETY DEVICE WHEN IT COMES TO THE USE OF YOUR FIREARM AND SMITH & WESSON WILL NOT BE RESPONSIBLE FOR ANY PERSONAL INJURY, DEATH OR PROPERTY DAMAGE THAT RESULTS FROM: (1) THE CRIMINAL OR NEGLIGENT USE OF THIS FIREARM; (2) A DISREGARD OF THESE SAFETY INSTRUCTIONS AND WARNINGS; (3) IMPROPER OR CARELESS HANDLING OF THIS FIREARM; (4) THE USE OF NON-STANDARD, DEFECTIVE, IMPROPER OR RELOADED AMMUNITION; OR; (5) IMPROPER OR NEGLIGENT MODIFICATIONS OR REPAIRS TO THE FIREARM.

SAFE STORAGE AND TRANSPORTATION



WARNING: ALWAYS POINT THE MUZZLE IN A SAFE DIRECTION.



WARNING: FIREARMS ARE DANGEROUS WHEN USED AND STORED IMPROPERLY. THEY POSE A RISK OF SERIOUS OR FATAL INJURIES. FIREARMS CAN BE ESPECIALLY DANGEROUS TO CHILDREN WHEN THEY ARE STORED IN AN IRRESPONSIBLE AND UNSAFE MANNER. FOR YOUR SAFETY AND THE SAFETY OF OTHERS, IT IS IMPERATIVE THAT YOU KEEP YOUR FIREARM LOCKED AND UNLOADED IN A SECURE PLACE. THE AMMUNITION SHOULD BE STORED IN A SEPARATE, SECURE LOCATION WHEN IT IS NOT IN USE. SAFE AND SECURE STORAGE OF YOUR FIREARM IS ONE OF THE MOST IMPORTANT RULES OF FIREARM SAFETY. YOUR FAILURE TO FOLLOW THESE RULES MAY RESULT IN SERIOUS INJURY OR DEATH TO YOU OR OTHERS.

- **ALWAYS SECURE YOUR FIREARM IN A MANNER THAT WILL PREVENT UNAUTHORIZED ACCESS.** Whenever your firearm is not in use, keep it unloaded and locked. Your safety and the safety of others requires that you always secure and store your firearm in a manner that will prevent unauthorized access. Never leave a firearm unattended unless it is locked, unloaded and secured.
- **ALWAYS USE THE LOCK PROVIDED BY SMITH & WESSON TO SECURE YOUR FIREARM.** Please read and follow the instructions packaged separately for the use of this lock. A lock, when properly used, can be an effective tool in preventing unauthorized access to your firearm. There are other alternative locks and safe storage containers available in the marketplace which may also be appropriate for your particular needs. Consult your local gun shop, hardware store, or local police department for guidance on the variety of other safe storage devices or practices which may be appropriate for your particular needs. By purchasing this firearm you have accepted the responsibility of safely securing the firearm at all times and preventing its unauthorized use. Never assume that the use of this lock alone is sufficient to safely secure your firearm. It is your personal responsibility to select and use whatever measures or practices that will enable you to be absolutely certain that your firearm is secure at all times.



WARNING: NEVER LOCK A LOADED FIREARM AND NEVER LOAD A LOCKED FIREARM!!

SAFE STORAGE AND TRANSPORTATION CONTINUED

- **ALWAYS STORE YOUR FIREARM AND AMMUNITION SEPARATELY** so that they are not accessible to children or other unauthorized persons. Safe and secure storage of your firearm and ammunition are your responsibility. It is a full-time responsibility.
- **NEVER ASSUME THAT A “HIDING” PLACE IS A SECURE STORAGE METHOD.** Others may be aware of your storage location or come upon it by chance. It is your personal responsibility to use common sense when storing your firearm and ammunition and to always make sure they are not accessible to children or other unauthorized persons.
- **NEVER TRANSPORT A LOADED FIREARM.** When transporting your firearm, be sure it is unloaded and locked. Safe and secure transportation of your firearm is your responsibility.
- **ALWAYS FOLLOW THE LAW!** Many jurisdictions have laws that make it a crime to keep a firearm unlocked and in an area accessible to children or others. Keeping a firearm locked and unloaded when not in use is not only common sense safety practice... IT IS THE LAW. You must be familiar with all local, state, and federal laws regarding the safe storage and transportation of your firearm. Failure to know and follow the law may result in unauthorized access or use of your firearm by another. Obey all laws relating to the storage and transportation of firearms. Your local police department or gun shop can furnish you with available information on storing and/or transporting a firearm safely and legally.
- **YOUR FIREARM IS YOUR RESPONSIBILITY.** You must prevent your firearm from being stolen or from being used by untrained or unqualified individuals. Keep it locked, unloaded and secured when not in use.

AMMUNITION



WARNING: NEVER USE AMMUNITION NOT SPECIFICALLY DESIGNATED FOR USE IN YOUR FIREARM. FAILURE TO USE THE CORRECT TYPE OR CALIBER OF AMMUNITION MAY CAUSE THE FIREARM TO JAM, FAIL TO FIRE OR EVEN GENERATE EXCESSIVE PRESSURE WHICH CAN DAMAGE OR EVEN RUPTURE YOUR FIREARM, CAUSING PERSONAL INJURY, DEATH OR PROPERTY DAMAGE.

Locate the cartridge designation marked on the firearm. This information indicates the correct ammunition that must be used in this firearm (FIGURE 1).

You are responsible for selecting ammunition that meets industry standards and is appropriate in type and caliber for this firearm.



Never use a cartridge not specifically designated for use in your firearm. The wrong type of ammunition may exceed the capability of your firearm and may damage or even rupture your firearm.

Never mix ammunition.

In some cases, a round of ammunition not specified on your firearm may fit into the chamber. Firing ammunition not specified on your firearm may cause it to rupture and cause serious injury or death to you or others.

Always inspect your ammunition before using it. Never use dirty, corroded or damaged ammunition which can lead to a burst cartridge which may cause personal injury, death or property damage.

Use only commercially manufactured ammunition with internal ballistic pressures which are in strict accordance with the specifications of the Sporting Arms and Ammunition Manufacturers' Institute (SAAMI). If you are uncertain, contact your ammunition supplier for verification.

A firearm and ammunition are a system and must work together. There are different types of ammunition for different types of firearms. Your firearm has been designed for ammunition of a specific type and a specific gauge or caliber. It is important to select the proper ammunition for your firearm.

AMMUNITION CONTINUED



WARNING: NEVER USE AMMUNITION OF THE INCORRECT GAUGE OR CALIBER. USING AMMUNITION OF THE INCORRECT GAUGE OR CALIBER MAY CAUSE DAMAGE TO YOUR FIREARM AND POSSIBLE SERIOUS INJURY TO YOU AND TO OTHERS.



WARNING: NEVER USE CARTRIDGES OTHER THAN THOSE DESIGNATED BY THE MARKING ON THE FIREARM. DOING SO CAN RESULT IN DANGEROUSLY HIGH PRESSURES THAT MAY DAMAGE THE FIREARM AND POSSIBLY CAUSE SERIOUS INJURY TO YOURSELF AND OTHERS.



WARNING: DEATH, SERIOUS INJURY AND DAMAGE CAN RESULT FROM THE USE OF INCORRECT AMMUNITION OR BORE OBSTRUCTIONS. NEVER USE RELOADS OF ANY KIND.

Some brands of ammunition may cause difficulty in extracting cartridge cases from the chamber. If this situation occurs, thoroughly clean the chamber with solvent. If this condition persists, we recommend changing to another brand of ammunition.

Smith & Wesson has found wide variations in primer sensitivity between some brands and types of .22LR ammunition. Smith & Wesson recommends that before you put your .22LR handgun into regular use, that you fire several boxes of your brand of ammunition through it to determine reliability of ignition. If a “failure to fire” occurs, try different types or brands of .22LR ammunition until a reliable loading is found.

MODEL AND FEATURES IDENTIFICATION

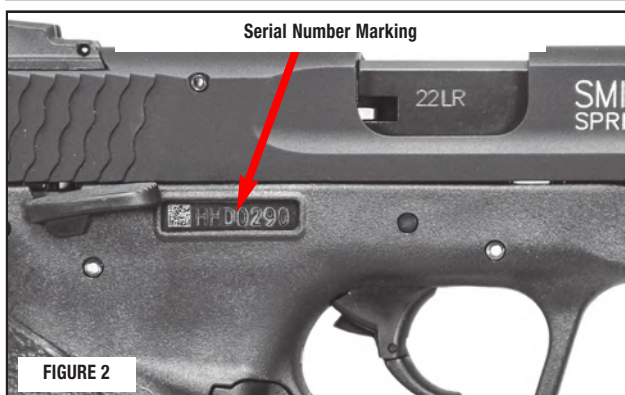

INSPECTING YOUR PISTOL



WARNING: ALWAYS KEEP THE MUZZLE POINTED IN A SAFE DIRECTION.



WARNING: ALWAYS ENSURE THAT THE FIREARM IS UNLOADED BEFORE INSPECTING, DISASSEMBLING OR ASSEMBLING.

- Check for yourself to ensure that the firearm is unloaded. To do this, grasp the pistol with your finger off the trigger and outside the trigger guard, point the pistol in a safe direction, depress the magazine release and remove the magazine (FIGURE 5).



FIGURE 5

- Point the muzzle in a safe direction, grasp the serrated sides of the slide from the rear with the thumb and fingers (FIGURE 6) and *briskly* draw the slide fully rearward to extract any cartridge from the barrel chamber and clear it from the pistol. Do not obstruct the ejection port because doing so can interfere with ejection of a cartridge.



FIGURE 6

- Lock the slide in the open position, by allowing the slide to move slightly forward from the rearmost position while pressing upward on the slide stop (FIGURE 7).



FIGURE 7

INSPECTING YOUR PISTOL CONTINUED

- Check the barrel chamber and bore visually for any cartridges or obstructions. Inspect the breech face to ensure that the firing pin is not protruding from the breech face (FIGURES 8a, 8b and 8c).

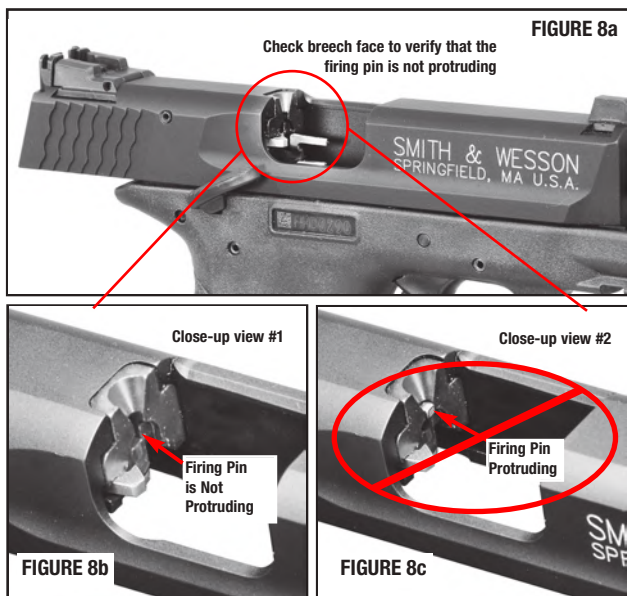

WARNING: VERIFY THAT THE FIRING PIN IS NOT PROTRUDING FROM THE BREECH FACE. IF THE FIRING PIN IS PROTRUDING, MAKE SURE THE FIREARM IS POINTED IN A SAFE DIRECTION, UNLOAD THE FIREARM AND HAVE IT INSPECTED AND TEST FIRED BY A GUNSMITH QUALIFIED TO PERFORM SERVICE ON SMITH & WESSON FIREARMS.

- Ensure that the slide moves freely along the frame through its full length of travel (FIGURES 9 and 10). Lock the slide in the “open” position as described above.



- You must follow this inspection procedure every time your firearm leaves your hand, is cleaned, handed to another person, transported or stored.

MANUAL THUMB SAFETY

Your M&P22 COMPACT pistol is equipped with an ambidextrous manual thumb safety.



WARNING: NEVER RELY ON MECHANICAL FEATURES ALONE. ONLY YOUR SAFE GUN HANDLING WILL ENSURE THE SAFE USE OF YOUR FIREARM. THIS IS YOUR RESPONSIBILITY.

- This feature prevents the trigger from moving rearward when the thumb safety lever is in the “SAFE” position.
- Push the thumb safety lever fully upward to put it in “SAFE” position (FIG. 11).
- Lower the thumb safety lever fully to put it in “FIRE” position allowing the pistol to be fired when the trigger is pulled (FIGURE 12).

NOTE: A Magazine Safety prevents the pistol from firing when the magazine is removed from the pistol. See Magazine Safety Section.

- The slide can still be opened and closed regardless of the position of the safety lever.
- The magazine can be removed and installed in the pistol regardless of the position of the safety lever.
- The pistol can be loaded and unloaded regardless of the position of the safety lever.

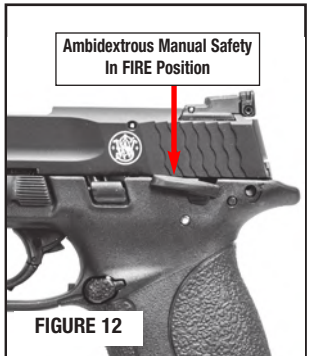
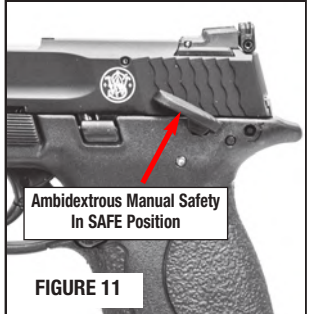

INTERNAL LOCK

Your M&P22 COMPACT pistol is equipped with an internal key operated lock (FIGURE 13).



WARNING: NEVER RELY ON THE INTERNAL LOCK MECHANISM AS THE SOLE METHOD TO SECURE YOUR FIREARM FROM UNAUTHORIZED USE.



WARNING: YOUR FIREARM IS YOUR RESPONSIBILITY. YOU MUST PREVENT YOUR FIREARM FROM BEING STOLEN OR FROM BEING USED BY UNTRAINED OR UNQUALIFIED INDIVIDUALS. KEEP IT LOCKED, UNLOADED AND SECURED WHEN NOT IN USE.

- This feature prevents the pistol from firing when it is locked. The manual safety is locked in the up position when the lock is engaged.
- The Internal Lock is accessible only when the Safety Lever is up in the “SAFE” position.
- To lock the pistol, insert the key into the keyhole and turn it clockwise (FIGURE 14).

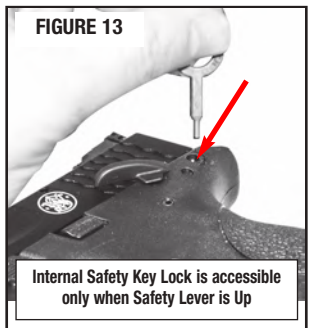

- To unlock the pistol, insert the key into the keyhole and turn it counterclockwise.
- When the internal lock is locked, the slide can still be opened and closed.

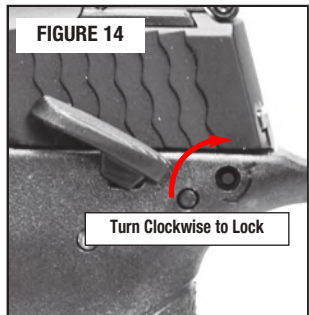

- When the internal lock is locked, the magazine can be removed and installed in the pistol.



WARNING: NEVER LOCK A LOADED FIREARM AND NEVER LOAD A LOCKED FIREARM!

- Keys are available from Smith & Wesson if you need a replacement.

MAGAZINE SAFETY



WARNING: YOUR M&P22 COMPACT PISTOL IS EQUIPPED WITH A MAGAZINE SAFETY. IN ORDER FOR THE MAGAZINE SAFETY TO OPERATE CORRECTLY, YOU MUST FULLY RELEASE THE TRIGGER AND REMOVE YOUR FINGER FROM WITHIN THE TRIGGER GUARD PRIOR TO THE MAGAZINE BEING REMOVED FROM THE PISTOL. FAILURE TO FULLY RELEASE THE TRIGGER COULD RESULT IN AN ACCIDENTAL DISCHARGE WHEN THE TRIGGER IS THEN PULLED THE REST OF THE WAY REARWARD - REGARDLESS OF THE PRESENCE OF A MAGAZINE IN THE PISTOL. "STAGING" THE TRIGGER (KEEPING TENSION ON THE TRIGGER) VIOLATES A BASIC RULE OF FIREARM SAFETY WHICH WARNS YOU TO KEEP YOUR FINGER OFF THE TRIGGER AND OUT OF THE TRIGGER GUARD UNTIL YOU HAVE MADE THE COMMITMENT TO FIRE. "STAGING" CREATES A SERIOUS RISK OF PERSONAL INJURY OR DEATH SINCE IT MAY LEAD TO AN UNINTENTIONAL DISCHARGE.

LOADED CHAMBER INDICATOR



WARNING: NEVER RELY UPON THE LOADED CHAMBER INDICATOR ALONE TO VERIFY THE PRESENCE OR ABSENCE OF A ROUND IN THE CHAMBER. THE SUREST METHOD TO DETERMINE THE PRESENCE OR ABSENCE OF A ROUND IN THE CHAMBER IS TO VISUALLY CHECK THE CHAMBER OF YOUR FIREARM BY REMOVING THE MAGAZINE AND PULLING AND LOCKING THE SLIDE IN THE OPEN POSITION (FIGURE 15).

M&P22 COMPACT pistols come with a loaded chamber indicator. This indicator can be observed by looking at the top of the slide/ejection port (FIGURE 16), noting an opening at the rear of the barrel hood. By looking into this opening, you can observe whether or not a round is in the firearm's chamber. If a round is in the chamber, you should be able to see the actual cartridge rim through this opening.



FIGURE 15

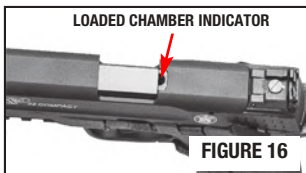

FIGURE 16



WARNING: ALWAYS TREAT EVERY FIREARM AS IF IT IS LOADED AND WILL FIRE IF THE TRIGGER IS PULLED. A LOADED CHAMBER INDICATOR MAY HELP DETERMINE WHETHER THE CHAMBER IS LOADED OR UNLOADED. THE AMOUNT OF LIGHT, CLEANLINESS OF THE PISTOL, COLOR OF THE AMMUNITION AND OTHER FACTORS MAY LIMIT THE EFFECTIVENESS OF THE LOADED CHAMBER INDICATOR.

PREPARATION FOR FIRING



WARNING: ALWAYS POINT THE MUZZLE IN A SAFE DIRECTION.



WARNING: THE FAILURE TO FOLLOW THESE FIREARM SAFETY REQUIREMENTS WILL CAUSE SERIOUS PERSONAL INJURY OR DEATH TO YOU OR OTHERS.

- **ALWAYS TREAT ALL FIREARMS AS IF THEY ARE LOADED.**
- **ALWAYS BE SURE THAT THE CHAMBER IS CLEAR OF A CARTRIDGE, THE MAGAZINE IS REMOVED OR UNLOADED, AND THAT THE FIREARM IS POINTING IN A SAFE DIRECTION.**
- **ALWAYS KEEP FINGERS AND OTHER PARTS OF YOUR BODY AWAY FROM THE MUZZLE AND AWAY FROM THE PISTOL SLIDE AND EJECTION PORT.**
- **ALWAYS WEAR ADEQUATE AND PROPER HEARING PROTECTION SPECIFIED FOR FIREARM USE** to prevent permanent damage to your hearing. Make sure others who are nearby are wearing ear protection as well.
- **ALWAYS WEAR SAFETY GLASSES SPECIFIED FOR FIREARM USE**, whether indoors or out. Safety glasses should protect your eyes from the firing flash and particles associated with the discharge of ammunition. Failure to do so creates a risk of personal injury from particle or debris spitting or a ricochet.
- **ALWAYS BE ALERT AND ALWAYS FOLLOW THE SAFETY INSTRUCTIONS OF THE RANGE OFFICER.** Never shoot if you are tired, cold or impaired in any way.
- **ALWAYS BE AWARE OF OTHER PEOPLE** so that persons do not accidentally walk into the line of fire.
- **THE SHOOTER (AND ALL OTHERS IN THE SHOOTING AREA) MUST ALWAYS BE IN A POSITION THAT IS OUT OF THE LINE OF FIRE** and are not within an area where they may be struck by a ricochet or particles spitting from a firearm, or by ejected cases from some types of firearms.
- **NEVER SHOOT AT SURFACES THAT MAY CAUSE A RICOCHET.** Always select a place to shoot that has a safe backstop, is free from obstructions and has no surfaces which may cause a ricochet.
- **NEVER FIRE RANDOMLY INTO THE SKY.** Always select a place to shoot that has a safe backstop.
- **NEVER USE ALCOHOL OR DRUGS BEFORE OR WHILE SHOOTING OR HANDLING ANY FIREARM.**

LOADING



WARNING: ALWAYS KEEP THE MUZZLE POINTED IN A SAFE DIRECTION.

- Do not load the pistol until you have read and fully understand this manual.
- Do not load the pistol until you are ready to use it. Keep your finger off the trigger and outside the trigger guard until you are ready to fire.
- Never load your pistol until you are sure of your target, what is beyond it and are fully prepared to fire.

If the magazine is removed for reloading and a round is left in the chamber, be sure to apply the safety and holster or otherwise secure the pistol under your direct control while the magazine is being reloaded.

- Smith & Wesson has provided you with a magazine designed to operate in your specific model of pistol. While your magazine may be able to be inserted into another model pistol, it will only function properly in the specific model for which it was designed. Do not interchange magazines from one model pistol into another model pistol.

- Follow instructions in this manual and any other specific instructions which may be marked onto, or accompany, a magazine. Failure to use the particular type of Smith & Wesson magazine specified for your model and caliber of pistol may result in a malfunction.

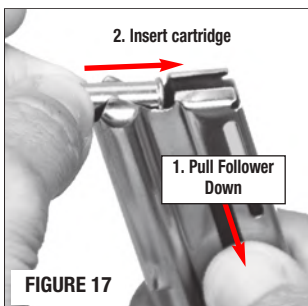

FIGURE 17

- Pull the magazine follower down with the loading assist button as you insert a cartridge rim (rear of cartridge) downward on the forward portion of the magazine follower (or downward on the case of the previously loaded cartridge) and sliding the cartridge fully under the lips of the magazine until the cartridge rim is against the rear wall of the magazine (FIGURES 17 and 18). Repeat the procedure for the number of cartridges you wish to load, up to the magazine capacity. Do not attempt to load your magazine with more than the specified number of cartridges because doing so can cause a feeding failure.

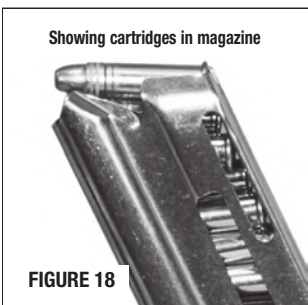

FIGURE 18

- Place the manual safety in the SAFE (up) position (FIG. 19).



FIGURE 19

LOADING CONTINUED



WARNING: VERIFY THAT THE FIRING PIN IS NOT PROTRUDING FROM THE BREECH FACE. IF THE FIRING PIN IS PROTRUDING, MAKE SURE THE FIREARM IS POINTED IN A SAFE DIRECTION, UNLOAD THE FIREARM AND HAVE IT INSPECTED AND TEST FIRED BY A GUNSMITH QUALIFIED TO PERFORM SERVICE ON SMITH & WESSON FIREARMS.



WARNING: ALWAYS LOAD A ROUND INTO THE CHAMBER BY FEEDING IT FROM THE MAGAZINE. FAILURE TO FOLLOW THIS WARNING CAN RESULT IN SEVERE INJURY OR DEATH TO YOU OR OTHERS. NEVER ATTEMPT TO LOAD THE PISTOL BY INSERTING A ROUND INTO THE OPEN EJECTION PORT.

- Inspect your pistol as previously described in the “Inspecting Your Pistol” section. Hold the pistol in one hand with the muzzle pointing in a safe direction and with your finger off the trigger and outside the trigger guard. Insert the loaded magazine into the magazine well (FIGURE 20) of the pistol until it is locked in place.



FIGURE 20

WARNING: DO NOT USE EXCESSIVE UPWARD FORCE WHEN INSERTING A LOADED MAGAZINE INTO THE PISTOL. EXCESSIVE UPWARD FORCE COULD CAUSE THE SLIDE TO MOVE FORWARD, CHAMBERING A ROUND AND MAKING THE PISTOL READY TO FIRE.

- Make sure that the magazine is fully and securely inserted by applying some downward pressure to the exposed portion of the magazine butt plate.
- Press down on the slide stop to release the slide and allow it to carry fully forward on its own under spring tension. Or, pull back on the slide and release it from your grasp. Either action will strip a cartridge from the magazine and seat it in the chamber of the barrel.

NOTE: Do not try to control forward movement of the slide. Interfering with forward spring-driven movement of the slide could adversely affect function of the pistol.



WARNING: THE PISTOL WILL FIRE IF THE MANUAL SAFETY IS PLACED IN THE FIRE (DOWN) POSITION AND THE TRIGGER IS PULLED.

LOADING CONTINUED

! WARNING: IF THE CARTRIDGE FAILS TO STRIP FROM THE MAGAZINE OR FULLY SEAT INTO THE CHAMBER, IMMEDIATELY STOP THE LOADING PROCESS. REMOVE THE MAGAZINE, LOCK THE SLIDE OPEN AND VERIFY THAT THE CHAMBER IS EMPTY. REFER TO THE “INSPECTING YOUR PISTOL SECTION” OF THIS MANUAL.

- Remember to keep your pistol pointed in a safe direction under all conditions and always keep your finger or any other object off the trigger and outside the trigger guard until you have made the commitment to fire the handgun. Never leave a loaded firearm unattended.

FIRING

! WARNING: ALWAYS KEEP THE MUZZLE POINTED IN A SAFE DIRECTION.

! WARNING: WEAR EYE AND HEARING PROTECTION SPECIFIED FOR FIREARM USE EVERY TIME YOU DISCHARGE YOUR FIREARM. MAKE SURE OTHERS IN THE VICINITY OF WHERE YOU WILL BE SHOOTING DO SO AS WELL.

! WARNING: UPON FIRING THE PISTOL OR RELEASING THE SLIDE FROM THE SLIDE STOP, THE SLIDE MOVES REARWARD OR FORWARD WITH SIGNIFICANT FORCE AND SPEED. TO AVOID INJURY BE SURE NO PART OF YOUR BODY IS IN THE PATH OF THE SLIDE’S TRAVEL.

- Keep your finger outside the trigger guard until you are ready to fire. Rotate the manual safety into the fire (down) position (FIGURE 21). While holding the grip firmly, pull the trigger fully to the rear.



FIGURE 21

- Upon firing, the slide moves rearward with considerable force thereby extracting and ejecting the spent cartridge case. The slide then returns forward, under spring tension, feeding the next cartridge from the magazine into the barrel chamber.

FIRING CONTINUED

- Allow the trigger to move fully forward after firing before you attempt to fire another shot. Failure to do so will prevent the lockwork from fully cycling and will prevent the firearm being able to fire the next shot. Keep your finger off the trigger and outside the trigger guard until you are ready to fire again. This sequence can be repeated until the last round has been fired, at which time the magazine follower exerts upward pressure on the slide stop causing it to engage the slide and to hold it in the “open” position.



WARNING: NEVER DRY-FIRE YOUR M&P22 COMPACT PISTOL, DAMAGE WILL RESULT.

CLEARING MISFIRES



WARNING: IF YOUR HANDGUN GIVES ANY INDICATION THAT IT IS NOT PERFORMING PROPERLY OR THE OPERATION OF YOUR HANDGUN HAS CHANGED “THE WAY IT FEELS OR SOUNDS”, STOP FIRING. MAKE SURE THE FIREARM IS POINTED IN A SAFE DIRECTION, UNLOAD THE FIREARM AND HAVE IT INSPECTED AND TEST FIRED BY A GUNSMITH QUALIFIED TO PERFORM SERVICE ON SMITH & WESSON FIREARMS.

- If a cartridge fails to fire, the chamber must be manually cleared.
- Wait ten seconds while keeping the muzzle pointed in a safe direction.
- Keep your finger off the trigger and out of the trigger guard.
- Verify that the manual safety is in the safe (up) position (FIGURE 21).
- Press the magazine release button and remove the magazine (FIGURE 22).



CLEARING MISFIRES CONTINUED

- Grasp the serrated sides of the slide from the rear and **briskly** pull the slide fully rearward to eject the misfired round. Do not obstruct the ejection port, and do not attempt to catch the round by placing your hand over the ejection port.

- Lock the slide in the open position by allowing the slide to move slightly forward from the rearmost position while pressing upward on the slide stop (FIGURE 23). You are now able to safely check the barrel chamber and bore visually for any obstructions.

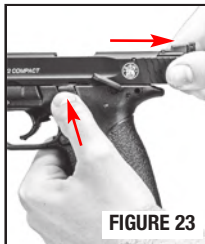

- Look into the chamber and down through the magazine well. Verify that no ammunition remains in the pistol (FIGURE 24).



UNLOADING



WARNING: ALWAYS KEEP YOUR PISTOL POINTED IN A SAFE DIRECTION. ALWAYS KEEP YOUR FINGER OFF THE TRIGGER AND OUTSIDE THE TRIGGER GUARD WHEN UNLOADING.

- Point the muzzle in a safe direction. Make sure your finger is off the trigger and out of the trigger guard. Verify that the manual safety is in the safe (up) position. Depress the magazine release, and remove the magazine (FIGURE 25).



FIGURE 25

- With the muzzle still pointing in a safe direction, and with your finger off the trigger and outside the trigger guard, grasp the serrated sides of the slide from the rear with your thumb and fingers, and **briskly** draw the slide fully rearward in order to extract any cartridge from the barrel chamber and clear it from the pistol. Do not obstruct the ejection port because doing so can interfere with ejection of a cartridge (FIGURE 26).



FIGURE 26

- Lock the slide to the rear by pushing the slide stop lever upwards while pulling the slide back and then allowing it to go forward slightly to be held rearward by the slide stop lever (FIGURE 27).



FIGURE 27

- Unload the magazine by holding it with the bullet end of the cartridge pointing away from you and pressing each cartridge forward and out of the magazine (FIGURE 28).

- Look into the chamber and down through the magazine well. Verify that no ammunition remains in the pistol.



FIGURE 28

SIGHT ADJUSTMENT



WARNING: ALWAYS ENSURE YOUR FIREARM IS UNLOADED BEFORE ADJUSTING YOUR SIGHTS. AT ALL TIMES FOLLOW THE BASIC RULES OF SAFE GUN HANDLING.

- The rear sight is fully adjustable for both windage and elevation.

ADJUSTING ELEVATION (FIGURE 29)

- Rotate the adjusting screw at the top/rear of the sight clockwise to lower the rear sight or counter-clockwise to raise the rear sight blade. (Raising rear sight blade will raise the group).



ADJUSTING WINDAGE (FIGURE 30)

- Windage adjustment is made by turning the set screw (1/16" Allen screw) and moving the sight left or right (moving rear sight to the right will move the group to the right). Move the rear sight in the direction you want your bullets to move on target.



NOTE: FIGURE 31 shows a closeup of the windage adjustment screw with “R” marking to indicate “Turn in this direction to make your shots hit further to the right.” The elevation screw is marked “UP” with an arrow to indicate the direction you need to turn the screw to make your shots hit higher.

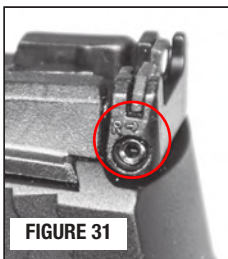

NOTE: There is no positive stop on the adjustment screws. Turning them too far will cause them to come out completely. Use caution to avoid losing the screws.

FIELD STRIPPING / DISASSEMBLY



WARNING: ALWAYS KEEP THE MUZZLE POINTED IN A SAFE DIRECTION.



WARNING: ALWAYS ENSURE THAT THE FIREARM IS UNLOADED BEFORE INSPECTING, DISASSEMBLING OR ASSEMBLING.



WARNING: ALWAYS FOLLOW THE FIELD STRIPPING INSTRUCTIONS EXACTLY. NEVER DO ANYTHING BEYOND WHAT YOU ARE SPECIFICALLY INSTRUCTED TO DO IN THIS MANUAL. NEVER ALTER OR MODIFY THE PARTS IN YOUR PISTOL.



WARNING: WEAR SAFETY GLASSES EVERY TIME YOU ASSEMBLE OR DISASSEMBLE YOUR FIREARM.

- Point the pistol in a safe direction. Make sure your finger is off the trigger, and the trigger is in the "at rest" or fully forward position.
- Depress the magazine release, and remove the magazine (FIGURE 32).
- With the barrel still pointing in a safe direction, and with your finger off the trigger and outside the trigger guard, grasp the serrated sides of the slide from the rear with the thumb and fingers while holding the firearm in an upright position, and **briskly** draw the slide fully rearward in order to extract any cartridge from the barrel chamber and clear it from the pistol (FIGURE 33).



FIGURE 32

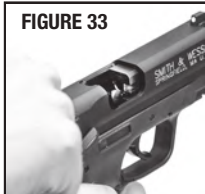

FIGURE 33

- With the slide fully rearward, press the slide stop lever up while allowing the slide to move slightly forward. This will hold the slide open in the correct position to allow disassembly (FIGURE 34).
- Rotate the takedown lever clockwise 90 degrees into the 6 o'clock position, as shown (FIGURE 35).

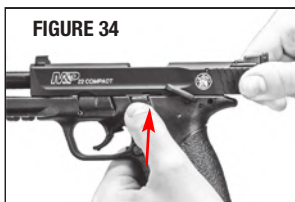

FIGURE 34

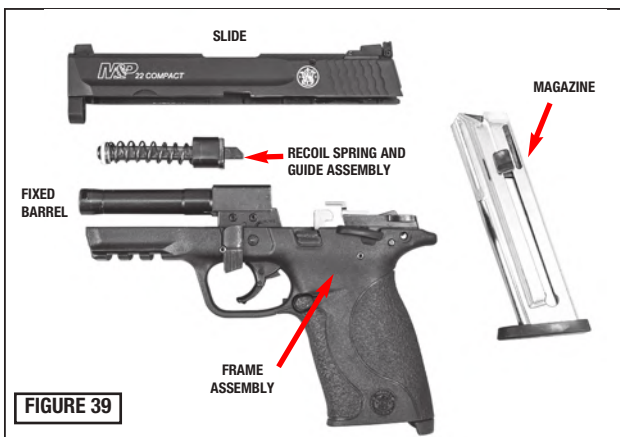

FIGURE 35

FIELD STRIPPING DISASSEMBLY CONTINUED

NOTE: The takedown lever is designed to remain captive. No attempt should be made to remove it from the frame.

- Pull the slide fully rearward and lift it up at the rear and off the frame (FIGURE 36).
- Move the slide (with the rear held up) forward under control until it is clear of the barrel (FIGURE 37).
- Set the slide aside.
- Remove the recoil spring and guide rod assembly from the frame and set them aside (FIGURE 38).
- This completes field stripping of the firearm. No further disassembly should be attempted.
- See a video of this procedure at www.smithwesson.com. Click on the model of firearm you have to see video.
- FIGURE 39 shows the pistol field stripped.



WARNING: NEVER DRY-FIRE YOUR M&P22 COMPACT PISTOL, DAMAGE WILL RESULT.

FIELD STRIPPING DISASSEMBLY CONTINUED



WARNING: DO NOT ALTER, MODIFY OR REPLACE ANY OF THE PARTS OF YOUR FIREARM UNLESS THIS WORK IS PERFORMED BY A QUALIFIED GUNSMITH USING GENUINE SMITH & WESSON PARTS. IF YOU DO OTHERWISE, IMPROPER FUNCTIONING MAY OCCUR AND SERIOUS INJURY MAY RESULT.



WARNING: NEVER DISASSEMBLE YOUR HANDGUN BEYOND THE FIELD STRIPPING PROCESS OUTLINED IN THIS MANUAL. NEVER MANIPULATE ANY INTERNAL COMPONENTS BEYOND WHAT YOU ARE SPECIFICALLY INSTRUCTED TO DO IN THIS MANUAL SINCE THIS MAY AFFECT THE RELIABILITY, FUNCTIONING AND SAFETY OF YOUR HANDGUN.

LUBRICATION

- Apply a single drop of firearm lubricant to each side of the pistol at the points shown (FIGURE 40) to ensure proper lubrication of your pistol. Do not to over-lubricate. Excess lubricant can collect large quantities of unburned powder and carbon residue, which could interfere with proper functioning of the pistol.

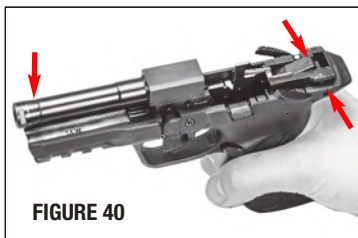

FIELD STRIPPING / ASSEMBLY



WARNING: ALWAYS ENSURE THAT THE FIREARM IS UNLOADED BEFORE INSPECTING, DISASSEMBLING OR ASSEMBLING.



WARNING: ALWAYS FOLLOW THE FIELD STRIPPING INSTRUCTIONS EXACTLY. NEVER DO ANYTHING BEYOND WHAT YOU ARE SPECIFICALLY INSTRUCTED TO DO IN THIS MANUAL. NEVER ALTER OR MODIFY THE PARTS IN YOUR PISTOL.



WARNING: WEAR SAFETY GLASSES EVERY TIME YOU ASSEMBLE OR DISASSEMBLE YOUR FIREARM.



WARNING: NEVER DRY-FIRE YOUR M&P22 COMPACT PISTOL, DAMAGE WILL RESULT.

- Make certain that the hammer is not in the fired position prior to assembling the pistol (FIG. 41) or the slide will not be able to be installed.
- If the hammer is in the fired position press it down and rearward into the cocked position (FIGURE 42).

NOTE: The top of the cocked hammer will be just slightly above the top of the rail (FIG. 42) to allow assembly of the slide on the frame.

- Replace the guide rod assembly into the frame as shown (FIGURE 43). The arrow points out the correct orientation of the sloped surface of the guide rod assembly.

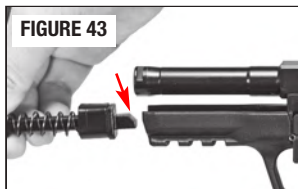
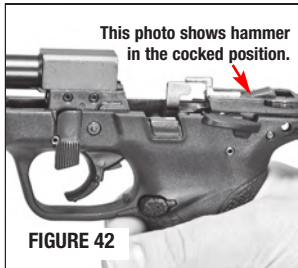
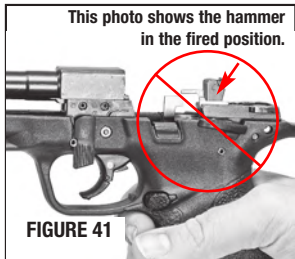

FIELD STRIPPING / ASSEMBLY CONTINUED

- Be certain that the guide rod appears as shown in FIGURE 44 when re-assembling the pistol. This is the correct installed position of the guide rod assembly to allow re-assembly of the slide onto the frame.

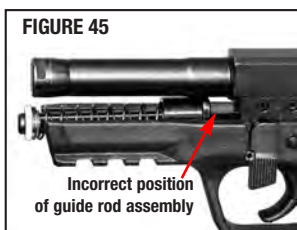
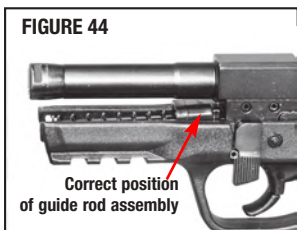

- FIGURE 45 shows the incorrect position of the guide rod assembly - the guide rod assembly in this position will prevent the slide from being re-assembled onto the frame.



- With the takedown lever in the "down" position (FIGURE 46), start the slide rearward over the barrel while keeping the recoil spring assembly in place (FIGURE 47).



- Continue pulling the slide rearward against the recoil spring's tension until it is as far back as it will go.



- With the slide fully rearward, press the rear of the slide down over the frame rails (FIGURE 48).



- Allow the recoil spring to pull the slide forward (FIGURE 49) on the frame rails.

FIELD STRIPPING / ASSEMBLY CONTINUED

- Pull the slide rearward and press the slide stop up to hold the slide in the open position (FIGURE 50).



- When the slide is locked open with the slide stop the takedown lever is aligned at a spot where it can be rotated (FIGURE 51).



- Rotate the takedown lever 90 degrees counter-clockwise as shown (FIGURES 52 and 53).



- Pull the slide to the rear to allow the slide stop to disengage and then release the slide, allowing the slide to move fully forward into the closed position (FIGURE 54).



- Following reassembly, and prior to attempting to load your pistol, always make certain that the pistol is in proper working order and that there are no unusual conditions to prevent its safe operation. Follow all of the inspection procedures outlined in the Inspection section of this manual.



- See a video of this procedure at www.smithwesson.com
Click on the model of firearm you have to see video.

MAGAZINE



WARNING: WEAR SAFETY GLASSES EVERY TIME YOU ASSEMBLE OR DISASSEMBLE YOUR MAGAZINE.



WARNING: THE MAGAZINE SPRING IS UNDER PRESSURE. CONTROL THE SPRING AND FLOOR PLATE RETAINER SO THAT THEY DO NOT FLY OUT AND CAUSE INJURY.

MAGAZINE DISASSEMBLY

For cleaning

- Remove all cartridges from magazine before disassembly (FIGURE 55).
- Press the magazine floor plate retainer down with a small screwdriver or punch (FIGURE 56).
- Control the floorplate retainer from flying out under spring pressure as you pull the floor plate off (FIGURE 57).
- FIGURE 58 shows the magazine floor plate retainer (on the spring) as it is ready to be removed from the magazine tube.
- Remove the spring from the magazine tube.
- Slide the magazine pull-down button down to the hole at the bottom of the magazine tube and lift it out to remove the button. This allows the magazine follower to then be removed from the bottom of the magazine (FIGURE 59).

NOTE: The magazine pull down button only goes into the follower from one side - in one direction. It is "keyed" to enter in only one direction (FIGURE 60).

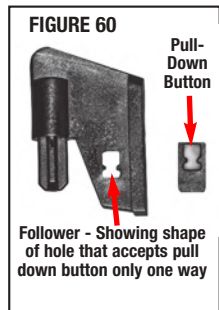
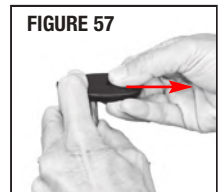
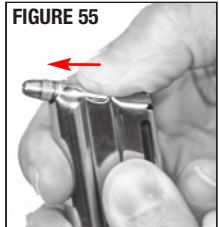
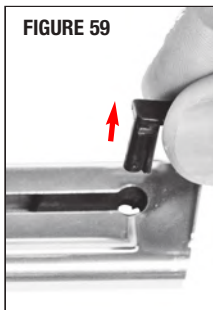

MAGAZINE CONTINUED

- FIGURE 61 shows the magazine disassembled.

MAGAZINE REASSEMBLY

- Insert the follower into the magazine tube (FIG. 62).
- Line up the hole at the bottom of the magazine tube with the key hole in the follower (FIGURE 63) and insert the pull-down button into the shaped hole of the follower. It is “keyed” to enter in only one direction.

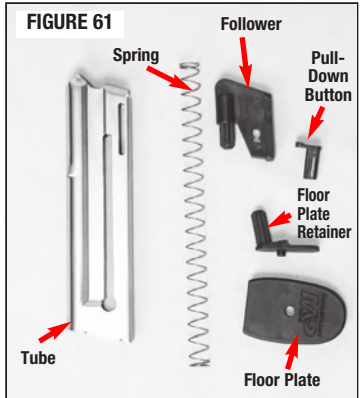

- Replace the spring (FIG. 64) and floor plate retainer (FIG. 65) - capture it against the spring pressure with your finger (FIG. 66).

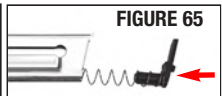
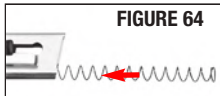
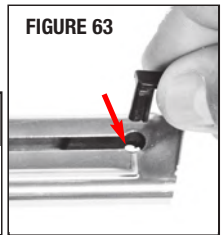
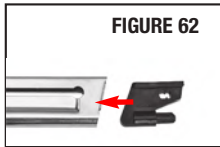

- While maintaining pressure on the floor plate retainer, slide the floor plate onto the magazine tube and ensure that it is fully seated (FIGURE 67). Check to make sure the

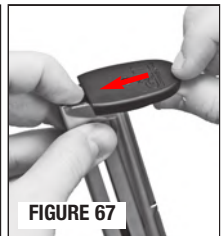
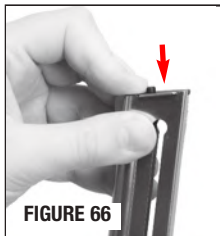

butt plate is secure by attempting to remove it gently - keeping in mind that the spring and retainer are now under tension and will fly out if the cover is removed quickly.

NOTE: The magazine button serves to interact with the slide stop. Be sure to check for proper function after re-assembly.

- See a video of this procedure at www.smithwesson.com
Click on the model of firearm you have to see video.

REVERSIBLE MAGAZINE CATCH



WARNING: ALWAYS KEEP THE MUZZLE POINTED IN A SAFE DIRECTION.

The magazine catch can be installed to operate from the right or left side. To reverse the magazine catch, follow these instructions:

- Field Strip the pistol (Pages 25-27).
- The spring rod that retains the magazine catch is located inside the magazine well (FIGURE 68 and 69).
- Move the magazine spring rod out of its notch in the magazine catch (FIGURES 70).
- Hold the spring rod out of the way with the screwdriver and slide the magazine catch out of the frame. Some turning and wiggling of the magazine catch is required.

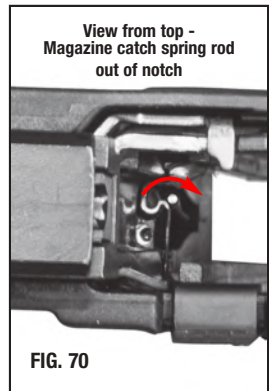
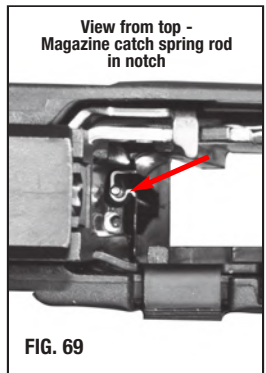
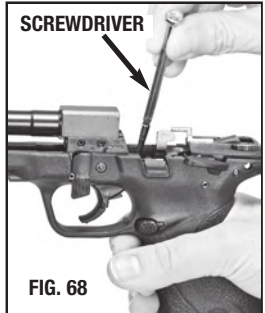

REVERSIBLE MAGAZINE CATCH CONTINUED

- FIGURE 71 shows the magazine catch out of the pistol to point out the details.

Magazine Catch Removed From Pistol - To Show Notch for Spring Rod

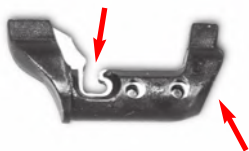

Put the side opposite the notch on the side of the pistol you want the release to function from.

FIG. 71

- Slide the magazine catch all the way out of the frame (FIGURE 72).

- Re-Insert the magazine catch from the right or left side of the frame according to your preference.

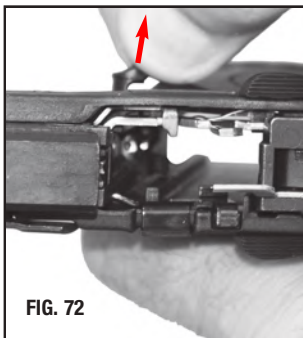

FIG. 72

- Re-engage the magazine catch spring rod in the notch of the magazine catch (FIGURE 73).

View From Top - Magazine Catch Spring Rod In The Notch

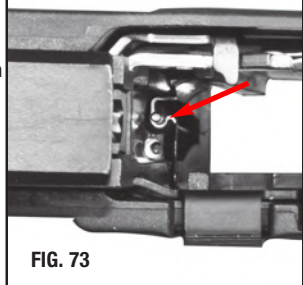

FIG. 73

- Insert the magazine into the pistol and check for proper function of the catch.

- Reassemble the pistol.

- See a video of this procedure at www.smithwesson.com Click on the model of firearm you have to see video.

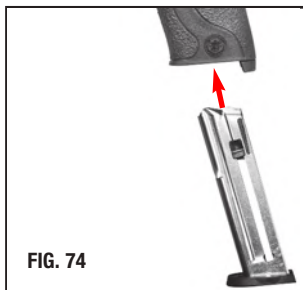

FIG. 74

CLEANING AND MAINTENANCE



WARNING: ENSURE THAT YOUR FIREARM IS UNLOADED BEFORE BEGINNING TO CLEAN IT. (SEE “INSPECTING YOUR FIREARM” SECTION). ALWAYS FOLLOW THE RULES OF SAFE GUN HANDLING.



WARNING: WEAR SAFETY GLASSES EVERY TIME YOU ASSEMBLE OR DISASSEMBLE YOUR FIREARM AND ATTEMPT CLEANING OR MAINTENANCE.

- Before using your firearm for the first time, it should be cleaned.
- Your firearm was treated at the factory with either a preservative or oil to protect it against corrosion during shipping and storage.
- Preservative and oil should be wiped from the bore, chamber and exposed areas using a clean swab or patch before using the firearm.

CAUTION: Never disassemble your firearm beyond the instructions in the Field Stripping and Inspection sections of this manual.

- Purchase cleaning supplies from your firearms dealer that are specifically designated for your type and caliber of firearm. Many suppliers offer these in kit form for your convenience.
- Follow the instructions provided with your cleaning supplies.

NOTE: A basic firearm cleaning kit should include: a brass bore brush and a cleaning jag of appropriate size for the bore being cleaned, high-quality gun cleaning solvent and gun oil/lubricant, cotton cleaning patches and a cleaning rod that is long enough to push the brush and jag completely through the barrel.

- Remove excessive firing residue from the bore and chamber using a properly fitted brass brush dipped in gun cleaning solvent. Finish the bore cleaning process by running a dry cotton cloth patch through the bore to remove residue and solvent.
- Clean the exterior of the firearm using a non-abrasive cleaning cloth.
- After cleaning, lightly coat the metal parts, internal and external with a high quality gun oil. Refer to the “Lubrication” section in this manual for instructions on lubricating the firearm.

Whenever your firearm has been exposed to sand, dust, extreme humidity, water or other adverse conditions, it must be cleaned and lubricated.

CLEANING AND MAINTENANCE CONTINUED



WARNING: ALWAYS HAVE ADEQUATE VENTILATION. CLEANING FIREARMS IN POORLY VENTILATED AREAS, DISCHARGING FIREARMS, OR HANDLING AMMUNITION MAY RESULT IN EXPOSURE TO LEAD AND OTHER SUBSTANCES KNOWN TO CAUSE BIRTH DEFECTS, REPRODUCTIVE HARM, AND OTHER SERIOUS PHYSICAL INJURY. WASH HANDS THOROUGHLY AFTER EXPOSURE.

CAUTION: Always follow the instructions provided with your gun cleaner and gun lubricant.

CAUTION: Some cleaners can cause damage to your firearms. You should avoid prolonged solvent immersion and avoid any ultrasonic cleaning of your firearm. Choice of solvent should be restricted to those products specifically developed for firearms maintenance. Damage to a firearm's finish may occur if these cautions are ignored. Ammoniated solvents or other strong alkaline solvents, should not be used on any Smith & Wesson firearm.

Cleaning is essential to ensure the proper functioning of your firearm.

Your firearm is a precision instrument. To ensure reliable function it is necessary to follow a routine maintenance procedure. After firing your firearm, be sure to unload it following the procedure outlined in the section entitled "Inspecting Your Firearm" before performing any cleaning or maintenance procedure.

Remove any gun cleaning solution, oil and fingerprints from the outside surfaces of the firearm. (Finger moisture, if left, could start a corrosion process.)



WARNING: NEVER MANIPULATE, ADJUST OR CHANGE ANY OF THE INTERNAL COMPONENTS OF YOUR FIREARM UNLESS SPECIFICALLY DIRECTED TO DO SO IN THIS MANUAL. IMPROPER MANIPULATION OF ANY INTERNAL COMPONENT MAY AFFECT THE SAFETY AND RELIABILITY OF YOUR FIREARM AND MAY CAUSE SERIOUS INJURY OR DEATH.



WARNING: ANY MAINTENANCE OR SERVICE NOT SPECIFIED IN THIS MANUAL MUST BE PERFORMED BY A QUALIFIED GUNSMITH USING GENUINE SMITH & WESSON PARTS. IF YOU DO OTHERWISE, IMPROPER FUNCTIONING OF YOUR FIREARM MAY OCCUR AND SERIOUS INJURY OR DEATH MAY RESULT.

If your firearm will be used in a cold climate, be sure to use an oil of an appropriate weight so that it will not congeal in cold temperatures, causing the interaction of important parts to be slowed or halted.

CLEANING AND MAINTENANCE CONTINUED

MAINTENANCE BEFORE STORAGE

When storing, do not encase your firearm in anything that will attract or hold moisture, for example, leather or heavy cloth. Also, do not store guns with a plug inserted in the barrel for this can be a contributing factor to moisture accumulation. If your firearm is to be stored for an extended period, the bore, chambers and internal working mechanism should be oiled with a high quality lubricating oil or preservative intended for firearms. The external working mechanisms and barrel should be coated with an anti-rust oil. Before using your firearm again, be sure to clean it. Every time you clean your firearm, check it for signs of wear. If excessive wear is noted, do not use the firearm. Return it to Smith & Wesson for service or have it checked by a qualified gunsmith.

LIMITED WARRANTY

For Owners Within The United States.

This warranty is granted by Smith & Wesson Corp. This warranty is effective from the date of purchase and applies to the original owner of any firearm. With respect to such firearms, this warranty supersedes any and all other warranties.

Smith & Wesson firearms are warranted to be free from defects in material and workmanship. Any such defects of which Smith & Wesson receives written notice within one year from the date of purchase by the original owner, will be remedied by Smith & Wesson without charge within a reasonable time after such notification and delivery of the firearm as provided below.

In the event of an emergency (repairs needed by law enforcement, an upcoming match or hunting trip), call 1-800-331-0852, ext. 4125 and ask for 911 Priority Repair Service. This allows you to speak with a Smith & Wesson representative. Immediately upon receipt, your firearm will be assigned to a gunsmith. After the work is completed, we will return your Smith & Wesson firearm via overnight delivery.

Warranty claims (in writing) and the firearm concerned should be delivered to Smith & Wesson's Customer Service Department, 2100 Roosevelt Avenue, Springfield, Massachusetts 01104. In addition, a copy of the bill of sale in the owner's name, or a copy of ATF Form 4473 indicating date of purchase must be included. It is important that the owner comply with all applicable federal, state and local laws and regulations in the shipment of firearms to Smith & Wesson.

NOTE: See the Contact And Shipping section of this manual for further details regarding returns.

LIMITED WARRANTY CONTINUED

Warranty claims should state the model and serial number of the firearm concerned and the description of the difficulty experienced. It is recommended that shipments be insured by the owner, since Smith & Wesson will accept no responsibility for loss or damage in transit. Transportation and insurance charges for return to owner will be paid by Smith & Wesson if the claim is covered by the warranty.

UNDER NO CIRCUMSTANCES SHALL SMITH & WESSON BE RESPONSIBLE FOR INCIDENTAL OR CONSEQUENTIAL DAMAGES WITH RESPECT TO ECONOMIC LOSS, INJURY, DEATH OR PROPERTY DAMAGE, WHETHER AS A RESULT OF BREACH OF THIS WARRANTY, NEGLIGENCE OR OTHERWISE.

Some States do not allow the exclusion or limitation of incidental or consequential damages, so the above limitation or exclusion may not apply to you.

Smith & Wesson will not be responsible for:

- Defects or malfunctions resulting from careless handling, unauthorized adjustments or modifications made or attempted by anyone other than a qualified gunsmith following Smith & Wesson authorized procedures, the use or installation of any unauthorized parts or accessories on the firearm, or failure to follow the disassembly instructions in the Smith & Wesson manual.
- Use of defective or improper ammunition, corrosion, neglect, abuse, ordinary wear and tear, or unreasonable use.
- Criminal misuse, negligence or use under the influence of drugs or alcohol.

Smith & Wesson's Lifetime Service Policy begins after the warranty period has expired. Smith & Wesson will repair, without charge, for the lifetime of the original owner, any Smith & Wesson handgun purchased on or after February 1, 1989, and any M&P series rifles, that is found to have a defect in material or workmanship. Eligibility for this Lifetime Service Policy requires returning the Product Registration Card within 30 days of purchase. The Lifetime Service Policy covers functional defects; it does not include the firearm's finish, grips, magazines or sights. The Lifetime Service Policy is in addition to and not an extension of the Smith & Wesson Warranty.

This warranty gives you specific legal rights. You may also have other rights that vary from State to State.

NOTE: All liability is excluded in the event that the instructions in the Smith & Wesson manual are not observed.

CONTACT AND SHIPPING INFORMATION

For Owners Within The United States

NOTE: A Return Merchandise Authorization (**RMA**) is the first step in the process of returning a product in order to receive a repair, replacement or refund. Please contact Smith & Wesson's Customer Service Dept. (via e-mail: qa@smith-wesson.com or by phone at 800-331-0852 ext. 4125) to obtain authorization to return your firearm so we can process it quickly and efficiently. The RMA number that is supplied by Smith & Wesson must be displayed on the outside of the returned product's packaging; returns without an RMA number will be routed differently which will result in delayed processing.

The issuance of an Return Merchandise Authorization (**RMA**) allows Smith & Wesson an opportunity to try to diagnose and correct a customer's concerns with the product (such as ammunition problems) before it is returned. Accordingly, please contact us before returning your Smith & Wesson firearm.

STEP 1: CONTACT CUSTOMER SERVICE

Tel: 800-331-0852 • 413-781-8300 ext. 4125
E-mail: qa@smith-wesson.com

STEP 2: RETURNS - FOR SERVICE

SEND ALL FIREARMS TO:
Smith & Wesson
2100 Roosevelt Avenue • Springfield, MA 01104

Should your Smith & Wesson firearm require service, it should be returned to the Smith & Wesson factory.

- Call or e-mail the Customer Service Dept. for authorization and shipping instructions.
- Ensure that the firearm is unloaded.
- **Do not attempt to ship a firearm via US Postal Service; only federally licensed dealers may ship a firearm by US Postal Service.**
- **DO NOT SHIP ANY AMMUNITION.**

CONTACT AND SHIPPING CONTINUED

- Enclose a letter which includes your full name and address (no P.O. Boxes, please), daytime telephone number, e-mail address, the serial number of the firearm, and details of the problem experienced (stating the brand and type of ammunition used when the problem occurred) or work desired.
- Record the serial number before shipping, in case you wish to check on the repair status of your firearm.
- Please remove all custom parts and accessories, such as stocks, special sights and scopes, or slings from your firearm before returning.
- Place the firearm in its original case or in a similarly secure container and pack it securely.
- The package must **NOT** bear any markings which indicate the identity of the contents.
- It is most important that you comply with federal, state, and local laws and regulations. The following guidelines are meant to help, but you must seek assistance from the appropriate authorities if necessary.
- If your firearm must be replaced, it may be necessary to ship the replacement to a dealer rather than directly to you. You will be requested to furnish a signed FFL (Federal Firearms License) from your dealer in such an instance.
- Warranty repair work will begin upon receipt and examination of the firearm. In the case of repairs or work not covered by the warranty, a quotation covering the cost of the work plus round trip transportation charges will be sent to you. Repairs or modification will be scheduled upon receipt of payment.
- A parts list can be obtained by contacting Smith & Wesson Customer Service.



WARNING: YOU MAY PURCHASE ACCESSORIES FOR YOUR SMITH & WESSON FIREARM. YOU MUST HAVE SOME OF THESE PARTS INSTALLED BY A GUNSMITH QUALIFIED TO PERFORM SERVICE ON SMITH & WESSON FIREARMS. YOU MUST NEVER ATTEMPT TO MODIFY YOUR FIREARM OR INSTALL REPLACEMENT PARTS IN YOUR FIREARM. ALWAYS USE A QUALIFIED SMITH & WESSON GUNSMITH EVEN IF THE REPAIR SEEMS TO BE SIMPLE.

CUSTOM SERVICE

We understand that Smith & Wesson gun owners may want to enhance their guns with custom gunsmithing, refinishing or accessories. Our gunsmiths offer specialized services and exclusive products to enhance your shooting experience.

Accessories for your Smith & Wesson firearm are available from your local Smith & Wesson Stocking Dealer, or directly from Smith & Wesson.

Contact the Customer Service Department at 1-800-331-0852, ext. 4125 for information about these services.

When ordering directly from the factory, please provide the following information:

- Model Number
- Dash Number
- Serial Number
- Approximate date of purchase
- Complete Return Address
- VISA/Discover/MasterCard Number & Expiration Date
- For Foreign Orders Only, Fax Number or E-mail Address

This handgun is not equipped with a device that fully blocks use by unauthorized users. More than 200,000 firearms like this one are stolen from their owners every year in the United States. In addition, there are more than a thousand suicides each year by younger children and teenagers who get access to firearms. Hundreds more die from accidental discharge. It is likely that many more children sustain serious wounds or inflict such wounds accidentally on others. In order to limit the chance of such misuse, it is imperative that you keep this weapon locked in a secure place and take other steps necessary to limit the possibility of theft or accident. Failure to take reasonable preventative steps may result in innocent lives being lost, and in some circumstances may result in your liability for these deaths.

The certification below is required only for handguns sold in the United States with a barrel length shorter than 3".

Smith & Wesson Corp. hereby certifies average accuracy test results for all new handguns with a barrel shorter than 3" as follows:

7 yards	14 yards	21 yards
1.7"	3.9"	6.3"

This certification is based on tests conducted by Smith & Wesson Corp. using a fixed handgun, rest and firing ammunition manufactured by a member of the Shooting Arms and Ammunition Manufacturers Institute (SAAMI) as defined in ANSI/SAAMI Z299.3-1993.

This certification represents actual tests based on several handguns, selected at random. Your particular handgun may have accuracy better than the results stated in this certification.

BATTERY WARNINGS



WARNING: IF A BATTERY OPERATED ACCESSORY OR ATTACHMENT (I.E. LASER, OPTICAL SIGHT OR FLASHLIGHT, ETC.) IS SUPPLIED OR USED WITH THIS FIREARM, THE FOLLOWING WARNINGS AND INSTRUCTIONS MUST BE ADHERED TO.



WARNING: KEEP BATTERIES AWAY FROM CHILDREN. THERE IS A CHEMICAL BURN HAZARD ASSOCIATED WITH BATTERIES.



WARNING: IF A NEW OR USED LITHIUM BUTTON/COIN CELL BATTERY IS SWALLOWED OR ENTERS THE BODY, IT CAN CAUSE SEVERE INTERNAL BURNS AND CAN LEAD TO DEATH IN AS LITTLE AS 2 HOURS. ALWAYS COMPLETELY SECURE THE BATTERY COMPARTMENT. IF THE BATTERY COMPARTMENT DOES NOT CLOSE SECURELY, STOP USING THE PRODUCT, REMOVE THE BATTERIES, AND KEEP IT AWAY FROM CHILDREN. IF YOU THINK BATTERIES MIGHT HAVE BEEN SWALLOWED OR PLACED INSIDE ANY PART OF THE BODY, SEEK IMMEDIATE MEDICAL ATTENTION.

- When used correctly, batteries provide a safe and dependable source of portable power. However, misuse or abuse may result in leakage, fire, or explosion.
- Batteries can explode or leak and cause burns if installed backwards, disassembled, charged, or exposed to water, fire or high temperature.
- Always take care to install your batteries correctly observing the “+” and “-” marks on the battery and the device.
- Always replace the whole set of batteries at one time, taking care not to mix old and new batteries, or batteries of different types.
- Store unused batteries in their original packaging and away from metal objects that may short-circuit them.
- Remove discharged batteries from equipment promptly to avoid possible damage from leakage.
- Never dispose of batteries in fire. (Failure to observe this precaution may result in an explosion.)
- The batteries are supplied in a charged state, are not designed for recharging. Recharging may cause leakage, fire, or explosion.
- The batteries should be disposed of properly, including keeping them away from children.
- Dispose of used batteries immediately.
- Even unused batteries may cause injury.

PATENT INFORMATION

This product may be covered by one or more patents.
Visit www.smith-wesson.com for virtual patent information.

WARRANTY CENTERS

NOTE: Addresses and other contact information for Warranty Centers are available on the Smith & Wesson website at www.smith-wesson.com or by calling Customer Service toll-free at 1-800-331-0852 ext 4125.



44 1930000 16325

Smith & Wesson
2100 Roosevelt Avenue • Springfield, MA 01104
www.smith-wesson.com

#441930000

REV:M&P22_COMPACT_PISTOL_112016