

WARRANTY REGISTRATION CARD

Please complete and return this card within 10 days from the date you purchased your firearm.

Name _____

Address _____

City _____ State _____ Zip _____

Date of Purchase _____

Email _____

Model Number _____

Caliber/Gauge _____

Serial Number _____

Price Paid _____ Your Age _____

To help us better understand our customers and enhance our products and service, we would appreciate answers to the following questions:

Where purchased: Gun Shop Sporting Goods Store

Discount Sporting Goods Store Discount/Chain Store

The primary use of this firearm is:

Varmint Shooting Target Shooting Pinking

Big Game Hunting Law Enforcement/Security

How many do you own: _____ Rifles _____ Shotguns _____ Handguns

Is this your first Savage: Yes No

You selected a Savage because (rank 1-10, with 10 being most important)

_____ Durability _____ Company Reputation _____ Price

_____ Catalog _____ Friend's Recommendation _____ Dealer/local Show

_____ Function _____ Accuracy _____ Magazine Ad

_____ TV Show _____ Dealer Recommendation _____ Other

Which group describes your family income:

Under \$20,000 \$20,000-\$39,999 \$40,000-\$59,999 \$60,000-\$74,999

\$75,000-\$99,999 \$100,000+

Estimated number of shells/cartridges you will use this year with this gun? _____

Do you read gun or hunting magazines? Yes No

List: _____

Do you watch gun or hunting shows? Yes No

List: _____

During what month did you investigate and decide on the model to buy? _____

Did your dealer: Have the firearm in stock Need to order it

Comments: _____

104796 (7/13) Rev. 3

Download a QR Code reader app
for your Smartphone and
then snap this to complete your
WARRANTY REGISTRATION on-line.



www.savagearms.com/customerservice/
warrantyregistration/

108633 REV 4(10/13)

www.savagearms.com

100 Springdale Road
Westfield, MA 01085



A los niños los atraen las armas de fuego y las pueden hacer funcionar. Ellos pueden causarse lesiones graves y la muerte. Evite que los niños tengan acceso a las armas de fuego guardándolas siempre con llave y descargadas cuando no las esté utilizando. Si usted tiene un arma de fuego cargada en un lugar en que un niño tiene acceso a ella y la usa indebidamente, le pueden dar una multa o enviarlo a la cárcel.



ADVERTENCIA

Children are attracted to and can operate firearms that can cause severe injury or death. Prevent child access by always keeping guns locked away and unloaded when not in use. If you keep a loaded firearm where a child obtains and improperly uses it, you may be fined or sent to prison.



WARNING



Savage Arms
The Definition of Accuracy

Safe ownership is your responsibility.
Please thoroughly read and understand this
manual before loading your firearm.

Keep firearms and ammunition away from
children. Lock unloaded firearms and
ammunition securely in separate locations.

This manual should always accompany your
firearm and be transferred with it upon
change of ownership. This is your respon-
sibility and may protect you from future
liability.

100 Springdale Road
Westfield, MA 01085

INSTRUCTION MANUAL

SAVAGE ARMS AXIS®
BOLT ACTION RIFLE

**IMPORTANT! DO NOT ATTEMPT TO LOAD AND SHOOT YOUR RIFLE UNTIL YOU HAVE THOROUGHLY
READ THIS INSTRUCTION MANUAL AND ARE FULLY FAMILIAR WITH ITS CONTENTS**

For more information, please visit our web site at www.savagearms.com



Savage®

Savage Arms, Inc.
100 Springdale Road
Westfield, MA 01085

Fold here and mail

WWW.SAVAGEARMS.COM



Download a QR Code reader app for your Smartphone
then snap this to open Savage Arms' homepage

Detach at perforation, seal edge with tape, affix postage and mail

AXIS I (STANDARD TRIGGER) and AXIS II (ACCUTRIGGER)

Congratulations on the purchase of your new firearm. You are now part of the Savage Sports Corporation family of quality firearms which includes Savage Arms, Inc., Savage Arms (Canada), Stevens, and Fox. With reasonable care, your firearm should deliver years of reliable service and perform to our "definition of accuracy".

THIS MANUAL IS EXTREMELY IMPORTANT.

The safety warnings and instructions in this manual are very important. By understanding the dangers involved in the use of any firearm and by taking the necessary precautions, you can use your Savage firearm in complete safety. However, failure to read, understand, and obey any of the warnings may result in serious injury or death to you or others, as well as severe damage to the firearm or other property.

This manual should always accompany your firearm and be transferred with it upon change of ownership. This is your responsibility and may protect you from future liability.

Savage Arms offers firearms designed in two ways: STANDARD TRIGGER (AXIS I) and ACCUTRIGGER (AXIS II). There are major differences between the two and it is the user's responsibility to read and understand them in their entirety. IF YOU USE IT IMPROPERLY – IT WILL NOT WORK. MORE IMPORTANTLY, IF YOU USE IT IMPROPERLY – SOMEONE MAY BE SERIOUSLY INJURED. IN BOTH CASES, THE KEY WORD IS YOU!

AS WITH ANY SAVAGE OR STEVENS FIREARM NOT INCORPORATING AN ACCUTRIGGER, THE TRIGGER MECHANISM ON THE AXIS I IS NOT ADJUSTABLE. ANY ADJUSTMENTS MADE AFTER THE FIREARM LEAVES THE FACTORY MAY RENDER IT UNSAFE TO SHOOT AND IS THE SOLE RESPONSIBILITY/LIABILITY OF THE USER.

For your convenience, SECTION 4 describes the ACCUTRIGGER. All of the other sections are common for both.

This INSTRUCTION MANUAL has been divided into 9 sections:

SECTION 1: Safety First – It's Your Responsibility!

SECTION 2: **TWO POSITION SAFETY**

SECTION 3: Basic Functions

- Installing and Removing the Bolt Assembly
- Cocking Indicator
- Removing/Installing the Stock
- Loading and Unloading
- Firing

SECTION 4: AccuTrigger Adjustment (Axis II ONLY)

SECTION 5: Parts List and Diagram

SECTION 6: Ammunition Bullet Weights / Magazine Capacities

SECTION 7: Rings And Bases For Mounting A Scope

SECTION 8: Maintenance

SECTION 9: Statement Of Limited Warranty

Although considerable time and effort were put into assuring the accuracy of the information contained herein, human errors do occur. If an error is found, please let us know. As a 'customer driven' company, we appreciate and encourage feedback.

SECTION 1 - SAFETY FIRST - IT'S YOUR RESPONSIBILITY

Above all – remember that a firearm is a mechanical device. It cannot think, it cannot act on its own – it only does what YOU MAKE IT DO. A mechanical device has no way to know if your actions are safe or if they will result in injury or death – THAT'S YOUR PART! It only takes one careless second to result in a tragedy that you will have to live with the rest of your life. MAKE NO DOUBT ABOUT IT, owning and/or using a firearm puts YOU in full control of its actions and THEIR CONSEQUENCES!

10 COMMANDMENTS OF SHOOTING SAFETY

FOR MORE INFORMATION, PLEASE VISIT OUR WEB SITE AT: WWW.SAVAGEARMS.COM

(The following excerpts are from SAAMI bulletin #081 1MM 7/97 BP The entire booklet can be obtained from the NATIONAL SHOOTING SPORTS FOUNDATION – WWW.NSSF.ORG)

FIREARMS SAFETY DEPENDS ON YOU!

FROM THE TIME YOU PICK UP A FIREARM, YOU BECOME PART OF A SYSTEM OVER WHICH YOU HAVE COMPLETE CONTROL. YOU ARE THE ONLY PART OF THE SYSTEM THAT CAN MAKE A GUN SAFE – OR UNSAFE.

You can help meet this responsibility by enrolling in hunter safety or shooter safety courses, if you have not already done so. You must constantly stress safety when handling firearms, especially to children and non-shooters. Develop safe shooting habits and remember, firearms safety is up to you. Make no mistake about it.

ALCOHOL, DRUGS AND GUNS DON'T MIX

1. ALWAYS KEEP THE MUZZLE POINTED IN A SAFE DIRECTION

This is the most basic safety rule. If everyone handled a firearm so carefully that the muzzle never pointed at something they didn't intend to shoot, there would be virtually no firearm accidents. It's as simple as that, and it's up to you.

Never point your gun at anything you do not intend to shoot. A safe direction means a direction in which a bullet cannot possibly strike anyone, taking into account possible ricochets and the fact that bullets can penetrate walls and ceilings. Even when "dry firing" with an unloaded gun, you should never point the gun at an unintended target.

This is your responsibility, and only you can control it.

2. FIREARMS SHOULD BE UNLOADED WHEN NOT ACTUALLY IN USE

Firearms should be loaded only when you are in the field or on the target range or shooting area, ready to shoot. When not in use, firearms and ammunition should be secured in a safe place, separate from each other. It is your responsibility to prevent children and inexperienced adults from gaining access to firearms or ammunition. A loaded gun has no place in or near a vehicle or building.

Whenever you handle a firearm or hand it to someone, always open the action immediately, and visually check the chamber, receiver and magazine to be certain they do not contain any ammunition. Never assume a gun is unloaded – check for yourself! While in the field, there will be times when common sense

and the basic rules of firearms safety will require you to unload your gun for maximum safety. When in doubt, unload your gun!

3. DON'T RELY ON YOUR GUN'S "SAFETY"

Treat every gun as though it can fire at any time, regardless of pressure on the trigger. The "safety" on any gun is a mechanical device, which, like any such device, can become inoperable at the worst possible time. The safety serves as a supplement to proper gun handling but cannot possibly serve as a substitute for common sense.

Never touch the trigger on a firearm until you actually intend to shoot.

Your firearm is a precision instrument. Regardless of the position of the safety, any bump strong enough to actuate the firing mechanism of a gun can cause it to fire. The only time you can be absolutely certain that a gun cannot fire is when the action is open and it is completely empty. You and the safe gun handling procedures you have learned are your gun's primary safeties.

4. BE SURE OF YOUR TARGET AND WHAT'S BEYOND IT

No one can call a bullet back. Don't shoot unless you know exactly what your bullet is going to strike. Be sure that your bullet will not injure anyone or anything beyond your target. You should keep in mind how far a bullet will travel if it misses your intended target or ricochets in another direction.

Be aware that even a .22 short bullet can travel over 1½ miles and a high velocity cartridge, such as a 30-06, can project a bullet more than 3 miles.

Shotgun pellets can travel 500 yards, and shotgun slugs have a range of over a half-mile.

5. USE CORRECT AMMUNITION

You must assume the serious responsibility of using only the correct ammunition for your firearm. Read and heed all warnings, including those that appear in the gun's instruction manual and on the ammunition boxes. Using improper or incorrect ammunition can destroy a gun and cause serious personal injury. It only takes one cartridge of improper caliber or gauge to wreck your gun, and only a second to check each one as you load it. Be absolutely certain that the ammunition you are using matches the specifications that are contained within the gun's instruction manual and the manufacturer's markings on the firearm barrel.

Hand loaded or reloaded ammunition deviating from pressures generated by factory loads or from competent recommendations specified in reputable hand loading manuals can be dangerous, and can cause severe damage to guns and serious injury to the shooter.

Ammunition that has become very wet or has been submerged in water should be discarded in a safe manner. Do not spray oil or solvents on ammunition or place ammunition in excessively lubricated firearms.

Form the habit of examining every cartridge you put in your gun. Never use damaged, old or questionable ammunition – the money you save is not worth the risk of possible injury or a ruined gun.

DISCHARGING FIREARMS IN POORLY VENTILATED AREAS, CLEANING FIREARMS OR HANDLING AMMUNITION MAY RESULT IN EXPOSURE TO LEAD AND OTHER SUBSTANCES KNOWN TO CAUSE BIRTH DEFECTS, REPRODUCTIVE HARM AND OTHER SERIOUS PHYSICAL INJURY. HAVE ADEQUATE VENTILATION AT ALL TIMES. WASH HANDS THOROUGHLY AFTER EXPOSURE.

6. IF YOUR GUN FAILS TO FIRE WHEN THE TRIGGER IS PULLED, HANDLE WITH CARE!

Occasionally, a loaded gun may not fire when the trigger is pulled. If this occurs, keep the muzzle pointed in a safe direction. Keep your face away from the breech. Then, carefully open the action, unload the firearm and dispose of the cartridge in a safe way.

Any time there is a cartridge in the chamber, your gun is loaded and ready to fire - even if you've tried to shoot and it did not go off. It could go off at any time, so you must always remember **RULE #1** and **WATCH THAT MUZZLE!**

7. ALWAYS WEAR EYE AND EAR PROTECTION WHEN SHOOTING

All shooters should wear protective shooting glasses and some form of hearing protectors while shooting. Exposure to shooting noise can damage hearing, and adequate vision protection is essential. Wearing eye protection when disassembling and cleaning any gun will also help prevent the possibility of springs, spring tensioned parts, solvents or other agents from contacting your eyes. No target shooter, plinker or hunter should ever be without them.

8. BE SURE THE BARREL IS CLEAR OF OBSTRUCTIONS BEFORE SHOOTING

Before you load your firearm, open the action and be certain that there is no cartridge in the chamber. Then glance through the barrel to be sure it is clear of any obstruction. Even a small bit of mud, snow, excess lubricating oil or grease in the bore can cause dangerously increased pressure, causing the barrel to bulge or even burst when firing, which can cause injury to the shooter and bystanders. Make it a habit to clean the bore with a cleaning rod and patch to wipe away anti-rust compounds in the gun each time immediately before you shoot it. If the noise or recoil on firing seems weak or doesn't seem quite "right", cease firing immediately and be sure to check that no obstruction or projectile has become lodged in the barrel.

9. DON'T ALTER OR MODIFY YOUR GUN, AND HAVE GUNS SERVICED REGULARLY

Firearms are complicated mechanisms, which are designed by experts to function properly in their original condition. Any alteration or change (other than adjusting the AccuTrigger™) made to a firearm after manufacture can make the gun dangerous and will usually void any factory warranties. Do not jeopardize your safety or the safety of others by altering the trigger, safety or other mechanism of any firearm or allowing unqualified person's to repair or modify a gun.

Your gun is a mechanical device, which will not last forever and is subject to wear. As such, it requires periodic inspection, adjustment and service.

10. LEARN THE MECHANISM AND HANDLING CHARACTERISTICS OF THE FIREARM YOU ARE USING

Not all firearms are the same. Consequently, never handle any firearm without first having thoroughly familiarized yourself with the particular type of firearm you are using, the safe gun handling rules for loading, unloading, carrying and handling that firearm, and the rules of safe gun handling in general. Locate the firearm's mechanical safety device and get familiar with the feel and "on/off" positions.

You should always read and refer to the instruction manual you received with your gun, or if you have misplaced the manual, simply contact the manufacturer for a free copy.

Having a gun in your possession is a full-time job. You cannot guess; you cannot forget. You must know how to use, handle, and store your firearm safely. Do not use any firearm without having a complete understanding of its particular characteristics and safe use. There is no such thing as a foolproof gun.

SECTION 2 – TWO POSITION SAFETY

THE SAVAGE AXIS IS UNIQUE UNTO ITSELF AND INCORPORATES FEATURES THAT YOU MAY NOT BE FAMILIAR WITH. PLEASE BE SURE TO READ THIS INSTRUCTION MANUAL CAREFULLY TO UNDERSTAND HOW THIS MODEL DIFFERS FROM OTHER SAVAGE MODELS.

PRIOR TO LOADING OR OPERATING, FAMILIARIZE YOURSELF THOROUGHLY WITH THESE OPERATING INSTRUCTIONS AND THE MAIN PARTS OF YOUR FIREARM.

IT IS SO IMPORTANT TO STRESS THAT A FIREARM IS NO MORE THAN AN ASSEMBLY OF MANY DIFFERENT COMPONENTS – A MECHANICAL DEVICE. AS SUCH, YOU ARE THE ONLY SAFETY MECHANISM THAT CAN PREVENT AN ACCIDENT.

AS A MECHANICAL DEVICE, YOUR FIREARM WILL NOT LAST FOREVER AND IS SUBJECT TO WEAR. WHEN SOMETHING DOES NOT SOUND, FEEL, OR LOOK RIGHT, SEEK THE ADVICE OF A PROFESSIONAL GUNSMITH IMMEDIATELY. NEVER TAKE A CHANCE.

FAILURE TO OBEY A SAFETY WARNING MAY RESULT IN INJURY TO YOU OR OTHERS.

KNOW HOW TO LOCATE AND OPERATE THE SAFETY MECHANISM.

ALWAYS BE SURE THE FIREARM (ESPECIALLY THE BARREL) IS FREE AND CLEAR OF ANY OBSTRUCTIONS THAT MAY RESTRICT (OR SLOW DOWN) THE BULLET FROM LEAVING THE MUZZLE AT ITS NORMAL RATE OF SPEED. THIS INCLUDES SNOW, WATER, BRUSH, SHRUBS, STICKS, LEAVES AND DEBRIS TO NAME A FEW. NEVER PLACE THE END OF A BARREL OR SUBMERGE A FIREARM UNDER WATER. RESTRICTING, SLOWING, OR STOPPING THE BULLET FROM LEAVING THE MUZZLE WILL CREATE AN EXCESSIVE AMOUNT OF PRESSURE TO BUILD UP BEHIND IT AND MAY LEAD

TO EXTENSIVE DAMAGE TO THE FIREARM AND PERSONAL INJURY TO THE SHOOTER AND/OR BYSTANDERS. SAFE OPERATION IS YOUR RESPONSIBILITY AND CAN ONLY BE CONTROLLED BY YOU!

KNOW EXACTLY WHERE YOU ARE POINTING THE BARREL OF A FIREARM AND WHY!

The safety on the Axis models has TWO POSITIONS:

- **FULL SAFE** - Pull safety button towards shooter (trigger blocked – bolt can be opened).
- **SAFETY OFF - READY TO FIRE.** Push safety button away from shooter.

FULL SAFE

1. The safety is in the *FULL SAFE* position when it has been moved fully rearward, covering the red “dot” (See FIGURE 1).
2. The safety should be moved into the *FULL SAFE* position prior to closing the bolt when the firearm is loaded.
3. In the *FULL SAFE* position, the trigger is blocked from moving and the bolt can still be opened.



FIGURE 1

WHEN CARRYING A LOADED FIREARM, THE SAFETY MUST ALWAYS BE IN THE FULL SAFE POSITION.

THE ONLY TIME YOU CAN BE ABSOLUTELY CERTAIN THAT A GUN CANNOT FIRE IS WHEN THE ACTION IS OPEN AND IT IS COMPLETELY EMPTY OF AMMUNITION.

SAFETY OFF – READY TO FIRE

1. The safety is in the *OFF* position when it has been moved fully forward, exposing the red “dot” (see FIGURE 2).



FIGURE 2

NEVER TRANSPORT/CARRY A LOADED FIREARM WITH THE SAFETY OFF.

**** REMEMBER – AS ON SOME OTHER SAVAGE MODELS, THERE IS NO MID-SAFE POSITION ON THE SAVAGE AXIS ****

SECTION 3 – BASIC FUNCTIONS

INSTALLING AND REMOVING THE BOLT ASSEMBLY AS WITH ANY SAVAGE OR STEVENS FIREARM NOT INCORPORATING AN ACCUTRIGGER, THE TRIGGER MECHANISM ON THE AXIS IS NOT ADJUSTABLE. ANY ADJUSTMENTS MADE AFTER THE FIREARM LEAVES THE FACTORY MAY RENDER IT UNSAFE TO SHOOT AND IS THE SOLE RESPONSIBILITY/LIABILITY OF THE USER.

BOLT ASSEMBLIES ARE SPECIFICALLY MATCHED TO A FIREARM. USING ANY OTHER BOLT ASSEMBLY MAY CAUSE EXTENSIVE DAMAGE TO THE FIREARM AND/OR SERIOUS INJURY TO THE SHOOTER OR BYSTANDER.

FIREARMS ARE SHIPPED WITH THE BOLT REMOVED AND PACKED IN A SEPARATE COMPARTMENT WITHIN THE BOX. PLEASE BE SURE TO LOCATE THE BOLT AND REMOVE IT PRIOR TO THROWING THE BOX OUT. IF MISPLACED OR LOST, THE COMPLETE FIREARM MUST BE RETURNED TO SAVAGE TO 'FIT' A NEW BOLT AT THE OWNER'S EXPENSE.

BEFORE INSTALLING THE BOLT, VERIFY THAT THE 4 DIGITS ENGRAVED BY THE EXTRACTOR MATCH THE LAST 4 DIGITS OF THE SERIAL NUMBER ON THE RECEIVER.

BE SURE THERE IS NO AMMUNITION IN EITHER THE CHAMBER OR MAGAZINE.

BOLT INSTALLATION (SEE FIGURE 3)

1. Rotate the FRONT BAFFLE (1) to line-up the BOLT UNDERCUT with the EXTRACTOR.
2. Pull the TRIGGER (2) fully rearward and hold it in that position.
3. Press down on the top of the BOLT RELEASE (3) as far as it will go.
4. **WITH NO AMMUNITION IN THE FIREARM**, insert the BOLT (4) into the firearm, pushing it forward.

5. Close the BOLT HANDLE (pushing downward) and verify that the **TWO POSITION SAFETY** is operational as explained in SECTION 2 of this manual.

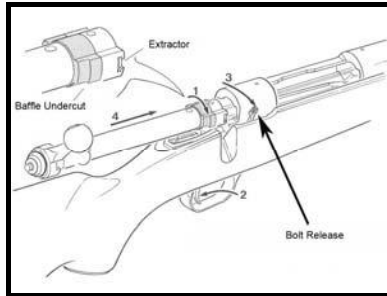

FIGURE 3

COCKING PIECE PIN

The primary purpose of the cocking piece pin is to control the forward movement of the firing pin assembly. Every time the bolt handle is raised, the cocking piece pin is pushed downward into a recess on the bottom of the triangular cutout at the rear of the bolt body (see FIGURE 4). In this position, the mainspring is cocked. When the bolt is closed and the handle pushed downward, the cocking piece pin moves to the center of the triangular cutout and is held in place by the sear (inside the receiver). Pulling the trigger drops the sear, releasing the cocking piece pin to snap forward and the firing pin to protrude from the bolt face with enough pressure and force to strike/detonate a primer. When the bolt handle is lifted, the cocking piece pin is again pushed downward into the recess in the triangular cutout; cocking the mainspring.

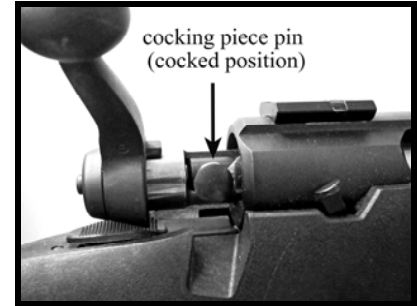

FIGURE 4

IF SOMEONE SHOULD PULL THE BOLT BACK SLIGHTLY (TO EXPOSE THE COCKING PIECE PIN FROM THE RECEIVER AS SHOWN IN FIGURE 4) AND DELIBERATELY PRY THE COCKING PIECE PIN OUT OF POSITION (SEE FIGURE 5), THE FIRING PIN WILL SNAP FORWARD – POTENTIALLY DISCHARGING THE CARTRIDGE.

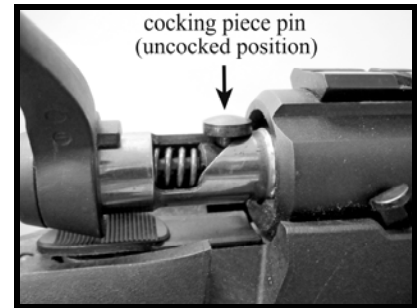

FIGURE 5

DETAILED IN THE INSTRUCTION MANUAL, THERE ARE CLEARLY DEFINED STEPS FOR THE SAFE OPERATION OF YOUR FIREARM, NONE OF WHICH REQUIRING THE COCKING PIECE PIN TO BE TOUCHED, MOVED, OR IN ANY WAY PUSHED OUT OF POSITION. AS WITH ANY FIREARM, PHYSICALLY MOVING OR FORCING ANY COMPONENT OUT OF ITS DESIGNED POSITION MAY RESULT IN DAMAGE, INJURY, OR EVEN DEATH.

AGGRESSIVELY CYCLING THE BOLT (I.E. SLAMMING IT REARWARD AGAINST THE SEAR) MAY CAUSE THE COCKING PIECE TO DISENGAGE AND UNCOCK – ALLOWING THE FIRING PIN TO SNAP FORWARD. NEVER CONTINUE TO SHOOT OR CYCLE LIVE AMMUNITION IF THE EJECTOR, COCKING PIECE PIN, OR ANY COMPONENT APPEARS WEAK OR NOT FUNCTIONING PROPERLY.

KNOW YOUR GUN! IF ANYTHING ‘FEELS’ OR SOUNDS DIFFERENT - STOP - AND HAVE A QUALIFIED GUNSMITH TAKE A LOOK! NEVER TAKE A CHANCE WITH SOMETHING THAT YOU ARE UNSURE OF ... ALWAYS ASK A PROFESSIONAL.

BOLT REMOVAL (see FIGURE 6)

1. With the muzzle pointed in a safe direction, verify the safety is in the READY TO FIRE position (see FIGURE 2).
2. Lift the bolt handle and pull fully to the rear.
3. **WITH NO AMMUNITION IN THE FIREARM**, pull the TRIGGER (1) fully rearward and hold it in that position.
4. Press down on the top of the BOLT RELEASE (2) as far as it will go.

5. Grasping the BOLT HANDLE, pull the bolt assembly fully rearward until it clears the receiver. If it seems to bind or stop, be sure that the trigger has been pulled fully rearward first and then the BOLT RELEASE pushed as far down as it will go.

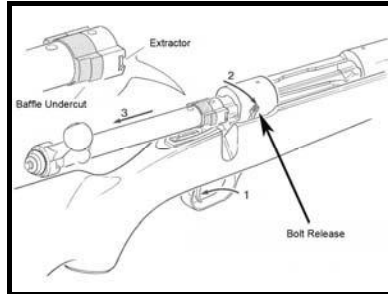

FIGURE 6

COCKING INDICATOR

SAVAGE ARMS HAS DESIGNED INTO THE CENTERFIRE BOLT ACTION SERIES, A COCKING INDICATOR. ITS MAIN PURPOSE IS TO VISUALLY INDICATE WHEN THE FIREARM IS COCKED. THIS IS NOT A LOADED CHAMBER INDICATOR NOR A SAFETY DEVICE WHICH CAN BE RELIED ON TO PREVENT ACCIDENTAL DISCHARGE – THAT RESPONSIBILITY LIES SOLELY IN THE HANDS OF THE SHOOTER!

1. Cocked – when the end of the ‘indicator’ is even with the end of the bolt assembly screw (see FIGURE 7).



FIGURE 7

2. Uncocked – when the end of the ‘indicator’ is not even (inside) with the end of the bolt assembly screw (see FIGURE 8).

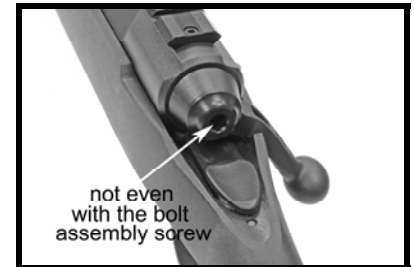

FIGURE 8

**REMOVING THE STOCK
ALWAYS REMOVE THE DETACHABLE BOX
MAGAZINE PRIOR TO REMOVING THE STOCK
(SEE FIGURE 9).**

WITH THE DETACHABLE BOX MAGAZINE REMOVED, BE SURE THE BOLT IS OPEN AND THERE IS NO LIVE AMMUNITION IN THE CHAMBER. LOOK AND FEEL WITH YOUR FINGER – THERE SHOULD BE NO DOUBT – THERE SHOULD BE NO QUESTION – THERE MUST BE NO AMMUNITION IN THE CHAMBER!

THE ONLY TIME YOU CAN BE ABSOLUTELY CERTAIN THAT A GUN CANNOT FIRE IS WHEN THE ACTION IS OPEN AND IT IS COMPLETELY EMPTY OF AMMUNITION.

1. Push the magazine release tab on the bottom of the stock rearward (see FIGURE 9), grasping and pulling the magazine clear of the stock.



FIGURE 9

2. Check and recheck to be sure there is no ammunition in the chamber.
3. Turn the firearm upside down, with the muzzle pointed away from you.
4. Using a 5/32" Allen wrench, loosen and remove the two action screws securing the stock (see FIGURE 10).

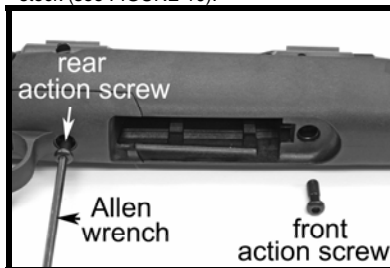

FIGURE 10

5. Remove the trigger guard section by pulling downward (see FIGURE 11).



FIGURE 11

6. Remove the stock.

BE SURE THE RECOIL LUG IS STILL POSITIONED CORRECTLY IN THE STOCK (SEE FIGURE 14). IF THE RECOIL LUG IS MISPLACED OR LOST – DO NOT USE THE FIREARM UNTIL IT HAS BEEN REPLACED (AVAILABLE THROUGH SAVAGE ARMS PARTS DEPARTMENT (SEE SECTION 5).

INSTALLING THE STOCK

IT IS CRITICAL THAT THE RECOIL LUG IS POSITIONED CORRECTLY IN THE STOCK TO PREVENT THE ACTION FROM EXCESSIVE REARWARD MOVEMENT DURING THE RECOIL AFTER SHOOTING.

1. Align the rear tab on the trigger guard with its mating 'hole' in the stock (see FIGURE 12).



FIGURE 12

2. Insert the tab end of the trigger guard section first and then rotate the front section into position (see FIGURE 11).

3. Verify the RECOIL LUG is positioned correctly in the stock channel (see FIGURE 13 and FIGURE 14).

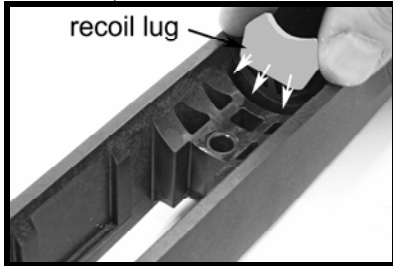

FIGURE 13

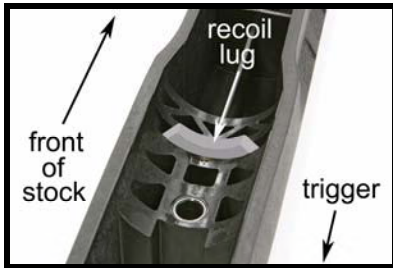

FIGURE 14

4. Position the action above the stock so that the recess in the receiver is perfectly aligned with the recoil lug in the stock (see FIGURE 15). NOTE: In FIGURE 15, the recoil lug has been removed from the stock to clearly illustrate its correct alignment with the receiver.

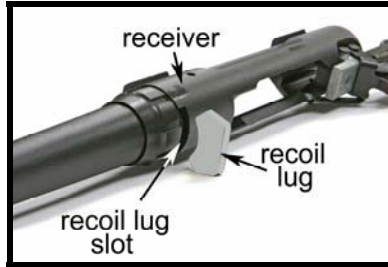

FIGURE 15

5. Carefully place the action into the stock, aligning the trigger with the trigger slot and the recoil lug with the recoil lug slot in the receiver.
6. With one hand around the action/stock in the trigger area and the other hand around the barrel/stock in the forend region, be sure the action is bedded solidly and does not rock. There should be no movement either front to back or up and down.
7. Maintaining downward pressure on the receiver to be sure the recoil lug remains engaged in the receiver slot, install the action screws (longer screw is to the rear and the shorter screw is to the front) into the stock (see FIGURE 10) and turn the wrench clockwise until the threads of the screws just engage into the receiver. DO NOT OVER TIGHTEN – the stock must be loose at this step!
8. Repeat STEP 6 to assure the recoil lug is still engaged correctly in the receiver slot prior to tightening the action screws.
9. Maintaining downward pressure on the receiver, tighten the front action screw first to approximately 40 inch pounds and then the

rear action screw securely to approximately 40 inch pounds.

KNOW YOUR GUN! IF ANYTHING 'FEELS' OR SOUNDS DIFFERENT - STOP - AND HAVE A QUALIFIED GUNSMITH TAKE A LOOK! NEVER TAKE A CHANCE WITH SOMETHING THAT YOU ARE UNSURE OF ... ALWAYS ASK A PROFESSIONAL.

10. Cycle the bolt several times to be sure that it functions properly. If you are unable to close the bolt handle completely, the action screws are reversed.

AFTER REASSEMBLING THE STOCK, VERIFY THAT THE SAFETY OPERATES CORRECTLY IN BOTH POSITIONS AS DEFINED IN SECTION 2 – 'TWO POSITION SAFETY' OF THIS MANUAL. SAFE OWNERSHIP IS YOUR RESPONSIBILITY!

LOADING

FIREARMS SHOULD BE LOADED ONLY WHEN YOU ARE IN THE FIELD, ON THE TARGET RANGE, OR AT A SHOOTING AREA READY TO SHOOT.

A LOADED GUN HAS NO PLACE IN OR NEAR A VEHICLE OR BUILDING.

ALWAYS KEEP THE MUZZLE POINTED IN A SAFE DIRECTION.

USE ONLY THE CORRECT AMMUNITION THAT IS INDICATED (STAMPED) ON THE BARREL.

THOROUGHLY CLEAN THE INSIDE OF THE BARREL AND CHAMBER PRIOR TO LOADING WITH AMMUNITION.

ALWAYS BE SURE THE FIREARM (ESPECIALLY THE BARREL) IS FREE AND CLEAR OF ANY OBSTRUCTIONS THAT MAY RESTRICT (OR SLOW DOWN) THE BULLET FROM LEAVING THE MUZZLE AT ITS NORMAL RATE OF SPEED. THIS INCLUDES SNOW, WATER, BRUSH, SHRUBS, STICKS, LEAVES AND DEBRIS TO NAME A FEW. NEVER PLACE THE END OF A BARREL OR SUBMERGE A FIREARM UNDER WATER. RESTRICTING, SLOWING, OR STOPPING THE BULLET FROM LEAVING THE MUZZLE WILL CREATE AN EXCESSIVE AMOUNT OF PRESSURE TO BUILD UP BEHIND IT AND MAY LEAD TO EXTENSIVE DAMAGE TO THE FIREARM AND PERSONAL INJURY TO THE SHOOTER AND/OR BYSTANDERS. SAFE OPERATION IS YOUR RESPONSIBILITY AND CAN ONLY BE CONTROLLED BY YOU!

THE USE OF RELOADS, HANDLOADS, MILITARY SURPLUS, OR ANY OTHER COMMERCIAL/ NONCOMMERCIAL AMMUNITION NOT MANUFACTURED TO SAAMI (SPORTING ARMS AND AMMUNITION MANUFACTURERS' INSTITUTE, INC.)/ANSI (AMERICAN NATIONAL STANDARDS INSTITUTE) SPECIFICATIONS WILL VOID THE WARRANTY.

KNOW YOUR GUN! IF ANYTHING 'FEELS' OR SOUNDS DIFFERENT WHEN LOADING OR SHOOTING - STOP - AND HAVE A QUALIFIED GUNSMITH TAKE A LOOK! NEVER TAKE A CHANCE WITH SOMETHING THAT YOU ARE UNSURE OF ... ALWAYS ASK A PROFESSIONAL.

1. With the muzzle pointed in a safe direction, move the safety fully rearward to the FULL SAFE position (see FIGURE 1).
2. Lift the bolt handle and pull fully rearward.
3. Push the magazine release tab on the bottom of the stock rearward (see FIGURE 9),

grasping and pulling the magazine clear of the stock.



FIGURE 16

4. As shown in FIGURE 16, load the correct caliber cartridges into the detachable box magazine by pressing downward, filling the magazine to capacity (see SECTION 6 – AMMUNITION BULLET WEIGHTS/MAGAZINE CAPACITIES).
5. Insert the detachable box magazine back into the stock opening by engaging the **rear first** and then pressing **upward on the front** until the latch is fully engaged.
6. Moving the bolt handle forward will push the first cartridge from the detachable box magazine into the chamber.

CLOSE THE BOLT SLOWLY TO BE SURE THE CARTRIDGE IS ALIGNED WITH THE CHAMBER. IF RESISTANCE IS FELT OR THE BOLT DOES NOT CLOSE, PULL REARWARD ON THE BOLT HANDLE, OPENING THE ACTION AND EJECTING

THE CARTRIDGE. CAREFULLY INSPECT THE TIP OF THE BULLET AND THE CARTRIDGE CASE TO BE SURE THAT THEY HAVE NOT BEEN DAMAGED, REINSERT IN THE MAGAZINE, AND CLOSE THE BOLT. IF IT HAPPENS AGAIN, TRY A NEW CARTRIDGE. IF THE PROBLEM PERSISTS, CALL SAVAGE ARMS – CUSTOMER SERVICE (413-568-7001 9:00AM TO 4:00PM EASTERN TIME).

ALWAYS KEEP THE MUZZLE POINTED IN A SAFE DIRECTION.

7. Push the bolt handle downward until it is firmly seated in position.

WHEN THE BOLT IS FULLY CLOSED, A LIVE CARTRIDGE WILL BE IN THE CHAMBER.

8. Verify the safety is still fully rearward in the FULL SAFE position (see FIGURE 1).

TO LOAD A SINGLE CARTRIDGE INTO THE CHAMBER

1. With the muzzle pointed in a safe direction, insert a cartridge into the chamber.
2. Depressing the cartridges in the magazine with one hand, slowly push the bolt forward allowing it to slide over the top of the cartridges in the magazine.
3. Push the bolt handle downward until it is firmly seated in position.
4. Verify the safety is still fully rearward in the FULL SAFE position (see FIGURE 1).

WHEN THE BOLT IS FULLY CLOSED, A LIVE CARTRIDGE WILL BE IN THE CHAMBER.

ALWAYS KEEP THE MUZZLE POINTED IN A SAFE DIRECTION.

TO FIRE

DO NOT MOVE THE SAFETY FORWARD TO THE SAFETY OFF – READY TO FIRE POSITION UNTIL YOU ARE READY TO SHOOT.

THE ONLY TIME YOU CAN BE ABSOLUTELY CERTAIN THAT A GUN CANNOT FIRE IS WHEN THE ACTION IS OPEN AND IT IS COMPLETELY EMPTY OF AMMUNITION.

NEVER TOUCH THE TRIGGER ON A FIREARM UNTIL YOU ACTUALLY INTEND TO SHOOT.

NEVER POINT YOUR GUN AT ANYTHING YOU DO NOT INTEND TO SHOOT.

BE SURE TO WEAR ADEQUATE EYE AND HEARING PROTECTION (CONSULT MANUFACTURER FOR THEIR RECOMMENDATION) WHEN EVER YOU INTEND TO SHOOT. HEARING LOSS AS WELL AS IRREPARABLE EYE DAMAGE CAN OCCUR UNLESS YOUR EYES AND EARS ARE PROPERLY PROTECTED .

ALWAYS KEEP THE MUZZLE POINTED IN A SAFE DIRECTION.

1. Keep your finger off the trigger and out of the trigger guard until you are ready to shoot.
2. Always look carefully around to be sure that no one will cross in front of you when you are ready to shoot.
3. Place the firearm to your shoulder and move the safety forward to the **SAFETY OFF – READY TO FIRE** position and take aim.
4. Place your finger in the trigger guard and when you are on target, squeeze the trigger slowly.

AXIS II (ACCUTRIGGER) - WITH SAFETY AS OUR PRIMARY CONCERN, THE ACCUTRIGGER DESIGN REQUIRES THE SHOOTER TO PLACE THEIR FINGER SQUARELY OVER THE ACCURELEASE (SEE FIGURE 17).



FIGURE 17

PULLING THE TRIGGER FROM THE SIDE OR NOT DIRECTLY REARWARD (SEE FIGURE 18) WILL CAUSE THE SEAR TO DISENGAGE AND BE BLOCKED BY THE ACCURELEASE (SEE FIGURE 20). ALTHOUGH A 'CLICK' MAY BE HEARD, THE SEAR IS BLOCKED, PREVENTING THE FIRING PIN FROM HITTING THE PRIMER. WHEN THIS HAPPENS, THE BOLT MUST BE RAISED AND LOWERED TO 'RECOCK' THE FIREARM.



FIGURE 18

NO ONE CAN CALL A BULLET BACK.

5. Pull up and fully rearward on the bolt handle to open the bolt and extract the fired case.
6. Moving the bolt handle forward will push the next cartridge from the magazine into the chamber.
7. Push the bolt handle downward until it is firmly seated in position.
8. Move the safety fully rearward to the **FULL SAFE** position (see FIGURE 1).

IT IS A GOOD PRACTICE TO CHECK THE ACTION SCREWS BEFORE AND AFTER EACH SHOOTING SESSION TO VERIFY THEY ARE SECURE.

**UNLOADING YOUR RIFLE
KEEP YOUR FINGERS AWAY FROM THE TRIGGER.**

KEEP THE MUZZLE POINTED IN A SAFE DIRECTION.

1. With the muzzle pointed in a safe direction, move the safety fully rearward to the FULL SAFE position (see FIGURE 1).
2. Lift the bolt handle and pull fully rearward, extracting the cartridge from the chamber.
3. Push the magazine release tab on the bottom of the stock rearward (see FIGURE 9), grasping and pulling the magazine clear of the stock.

LOOK AND FEEL! BE SURE THE CHAMBER IS EMPTY -- DO NOT TRUST THE EXTRACTOR -- DO NOT ASSUME!

A LOADED GUN HAS NO PLACE IN OR NEAR A VEHICLE OR BUILDING.

SECTION 4 – ACCUTRIGGER ADJUSTMENT (AXIS II ONLY)

AS WITH ANY SAVAGE OR STEVENS FIREARM NOT INCORPORATING AN ACCUTRIGGER, THE TRIGGER MECHANISM IS NOT ADJUSTABLE. ANY ADJUSTMENTS MADE AFTER THE FIREARM LEAVES THE FACTORY MAY RENDER IT UNSAFE TO SHOOT, RESULTING IN PROPERTY DAMAGE, INJURY, OR EVEN DEATH. THIS IS THE SOLE RESPONSIBILITY/ LIABILITY OF THE USER.

SAFE OWNERSHIP IS YOUR RESPONSIBILITY. PRIOR TO ADJUSTING THE ACCUTRIGGER PLEASE THOROUGHLY READ AND UNDERSTAND THE INSTRUCTION MANUAL IN ITS ENTIRETY.

ADJUSTING THE ACCUTRIGGER DOES NOT REQUIRE THE STOCK TO BE REMOVED.

MAKE SURE THE FIREARM IS UNLOADED AND THE BOLT IS OPEN BEFORE ADJUSTING THE ACCUTRIGGER.

1. Remove the trigger guard as shown in FIGURE 11.
2. Insert the ACCUTRIGGER supplied tool into the bottom of the trigger as shown in FIGURE 19; engaging the spring-tail with the slot on the tool.

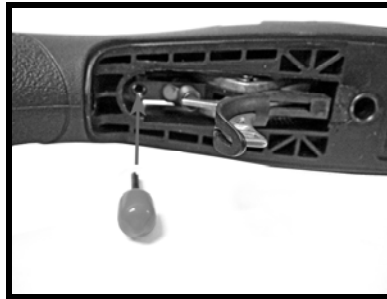

FIGURE 19

3. To adjust towards the higher range of pull, turn the tool clockwise. The maximum trigger pull is at the point where the spring “clicks” when rotated.
4. To adjust towards the lower range of pull, turn the tool counter-clockwise. The minimum trigger pull is at the point where you detect resistance.

THE SPRING SHOULD NOT BE FORCED BEYOND THESE LIMITS.

5. The ACCURELEASE adds an additional level of safety by blocking the sear (see FIGURE 20) if the rifle is accidentally jarred or dropped with the safety in the “FIRE” position.

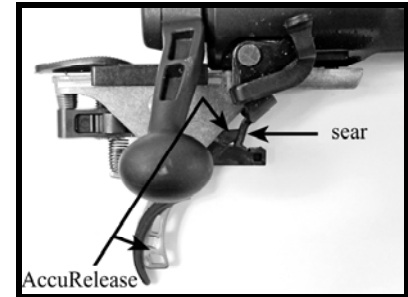

FIGURE 20

EXCESSIVE JARRING OR PULLING THE TRIGGER WITHOUT DEPRESSING THE ACCURELEASE MAY CAUSE THE SEAR TO MOVE (SEE FIGURE 20). AS DESIGNED, THE ACCURELEASE WILL PREVENT ACCIDENTAL DISCHARGE BY ‘LOCKING’ THE TRIGGER WHEN USED PROPERLY, MAINTAINED AND SERVICED REGULARLY. IN THIS EVENT, THE BOLT MUST BE RE-COCKED IN ORDER TO RESET THE SEAR.

WHEN THE SEAR IS BLOCKED BY THE ACCURELEASE (SEE FIGURE 20), THE FIRING PIN IS RESTRAINED WITHIN THE BOLT ASSEMBLY, PREVENTING IT FROM HITTING THE PRIMER. THE ‘CLICK’ THAT IS HEARD IS THE ACTUAL SEAR BEING BLOCKED BY THE ACCURELEASE, NOT THE FIRING PIN!

KNOW YOUR GUN! IF ANYTHING ‘FEELS’ OR SOUNDS DIFFERENT - STOP - AND HAVE A QUALIFIED GUNSMITH TAKE A LOOK! NEVER TAKE A CHANCE WITH SOMETHING THAT YOU ARE UNSURE OF ... ALWAYS ASK A PROFESSIONAL.

SECTION 5 – PARTS LIST AND DIAGRAM

As a 'customer driven' company, some parts may now be ordered directly from our web site (WWW.SAVAGEARMS.COM) twenty four hours a day, needing only your serial number and credit card. For accessing our part finder via your Smartphone, please use the QR Code below. Should you not have access to our web site, parts can be ordered directly from Savage Arms [413-568-7001] between the hours of 9:00 and 4:00 (Eastern Time). There is a minimum order and please allow 2 weeks for delivery. Only the parts indicated may be purchased by an individual. All other parts/ subassemblies are either 'factory fit' or available to qualified gunsmiths only.

Please be advised that some parts may require fitting. Savage Arms bears no responsibility for the function or performance of any firearm that has been repaired or modified by other than Savage Arms Service Department. As such, Savage Arms accepts no responsibility/liability for any direct and/or consequential damage and/or injury resulting from the use of a firearm repaired or modified by other than the Savage Arms Service Department.

QR Code for your Smartphone for purchasing parts directly from our website – no calls – no waiting – 24 hours a day.



STORE.SAVAGEARMS.COM/PARTFINDER

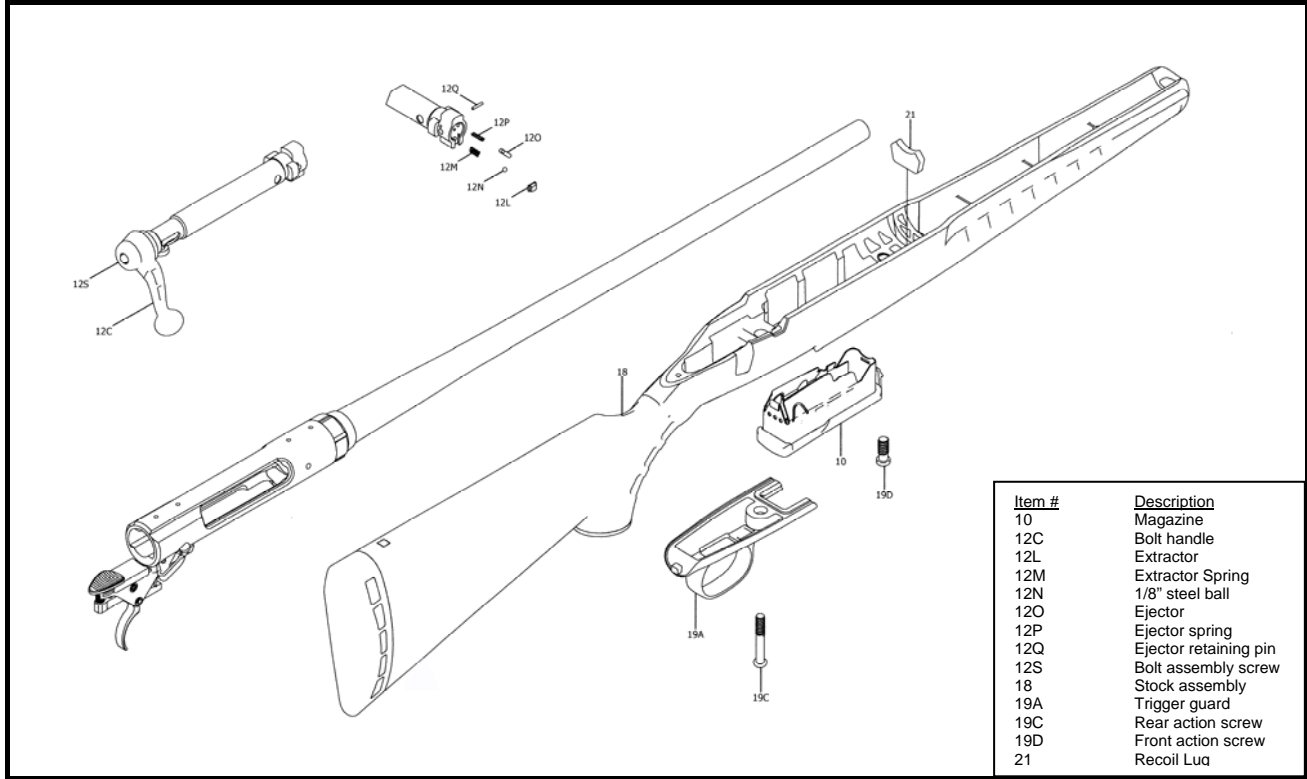

<u>Item #</u>	<u>Description</u>
10	Magazine
12C	Bolt handle
12L	Extractor
12M	Extractor Spring
12N	1/8" steel ball
12O	Ejector
12P	Ejector spring
12Q	Ejector retaining pin
12S	Bolt assembly screw
18	Stock assembly
19A	Trigger guard
19C	Rear action screw
19D	Front action screw
21	Recoil Lug

SECTION 6 – AMMUNITION BULLET WEIGHTS AND MAGAZINE CAPACITIES

Bullet specifications and trajectories are available directly from the ammunition manufacturer.

The following table lists the bullet weights used for 100 yard targeting evaluation at Savage Arms.

Performance may vary based on brand/type of ammunition, individual characteristics of the firearm, and/or shooting conditions.

USE ONLY THE CORRECT AMMUNITION THAT IS STAMPED ON THE BARREL.

THE USE OF RELOADS, HANDLOADS, MILITARY SURPLUS, OR ANY OTHER COMMERCIAL / NONCOMMERCIAL AMMUNITION NOT MANUFACTURED TO SAAMI (SPORTING ARMS AND AMMUNITION MANUFACTURERS' INSTITUTE, INC.) ANSI (AMERICAN NATIONAL STANDARDS INSTITUTE) SPECIFICATIONS WILL VOID THE WARRANTY.

Caliber	Bullet Weight (Grains)
22-250 Remington	Winchester 50 grain Ballistic Silver Tip
223 Remington	Federal 69 grain Sierra Match King BTHP
243 Winchester	Federal 70 grain Nosler Ballistic Tip
25-06 Remington	Federal 100 grain Nosler Ballistic Tip
270 Winchester	Federal 130 grain Nosler Ballistic Tip
30-06 Springfield	Federal 168 grain Sierra Match King BTHP
308 Winchester	Federal 168 grain Sierra Match King BTHP
7mm-08 Remington	Winchester 140 grain Ballistic Silver Tip

Caliber	Magazine Capacity
22-250 Remington	4
223 Remington	4
243 Winchester	4
25-06 Remington	4
270 Winchester	4
30-06 Springfield	4
308 Winchester	4
7mm-08 Remington	4

SECTION 7 – SCOPE RINGS AND BASES

RINGS FOR MOUNTING A SCOPE

The following are some companies that manufacture *RINGS* that may be used with a weaver style base or their own design.

The manufacturers listed below should be contacted for specific part numbers and information.

WEAVER MOUNTS
www.weaver-mounts.com

BURRIS
www.burrisoptics.com

KWIK-SITE
www.kwiksitecorp.com

MILLETT
www.milletsights.com

B-SQUARE
www.b-square.com

LEUPOLD
www.leupold.com

LEATHERWOOD /HI-LUX OPTICS
www.leatherwoodoptics.com

WARNE SCOPE MOUNTS
www.warnescopemounts.com

Evolution Gun Works (EGW)
www.egwguns.com

SECTION 8 – MAINTENANCE

YOUR GUN IS A MECHANICAL DEVICE WHICH WILL NOT LAST FOREVER AND IS SUBJECT TO WEAR. AS WITH ANY PRECISION TUNED MECHANICAL DEVICE, PERIODIC INSPECTION/ MAINTENANCE IS REQUIRED – AND YOUR RESPONSIBILITY!

AS WITH ANY SAVAGE OR STEVENS FIREARM NOT INCORPORATING AN ACCUTRIGGER, THE TRIGGER MECHANISM IS NOT ADJUSTABLE. ANY ADJUSTMENTS MADE AFTER THE FIREARM LEAVES THE FACTORY MAY RENDER IT UNSAFE TO SHOOT AND IS THE SOLE RESPONSIBILITY/LIABILITY OF THE USER.

1. TIMEFRAMES: It is difficult to establish a time period or number of rounds as the basis for when a firearm should be examined, cleaned, and thoroughly inspected. Different shooting conditions, weather patterns, and types of ammunition, to list a few, all play a significant role in answering the questions 'when' and 'how often'. As a general rule, 'more often' is much safer than 'not enough'.
 - As a start, the TWO POSITION SAFETY should be checked prior to loading live ammunition. This is an important step that should be done every time the firearm is prepared for use.
 - Remove the bolt, look down the barrel to be sure it is clear of any obstruction and that there are no signs of damage (nicks, scratches, etc.), rust, or pitting.
 - Check the outer surface of the barrel, running your fingers gently down its length, feeling for any bulges or signs of damage.
 - While the bolt is out, inspect the bolt head, extractor, and ejector for signs of damage or excessive wear.
 - With the stock removed, carefully inspect the trigger assembly for damage or foreign debris (twigs, grass, etc.).

- Carefully examine the stock and studs that secure the carrying strap.
- Check the scope rings to be sure they have not loosened.
- With the stock back on, verify the action screws are still tight.

- 2.- WHO SHOULD DO THE CHECKING: As the owner – or user – it is your primary responsibility to assure the firearm is safe prior to using it. Although we know its condition when it leaves the factory, we have no control or insight as to what has or has not been done once it leaves our hands.

After reading and understanding this INSTRUCTION MANUAL and prior to loading with live ammunition - you should be very familiar and capable of handling the items noted above. In depth mechanical issues or questions as well as periodic examinations should be referred to a qualified gunsmith or Savage Arms Service Department. Mechanical devices will by the nature of their design, wear and as such may require very specific adjustments. In the wrong hands, a 'simple' adjustment could result in serious damage to the firearm or even worse, injury or death to the shooter or bystander.

KNOW YOUR GUN! IF ANYTHING 'FEELS' OR SOUNDS DIFFERENT - STOP - AND HAVE A QUALIFIED GUNSMITH TAKE A LOOK! NEVER TAKE A CHANCE WITH SOMETHING THAT YOU ARE UNSURE OF ... ALWAYS ASK A PROFESSIONAL.

CLEANING AND CARE OF YOUR FIREARM BOLT ASSEMBLIES ARE SPECIFICALLY MATCHED TO A FIREARM. USING ANY OTHER BOLT ASSEMBLY MAY CAUSE EXTENSIVE DAMAGE TO THE FIREARM AND/OR SERIOUS INJURY TO THE SHOOTER OR BYSTANDER.

DISASSEMBLE ONLY ONE FIREARM AT A TIME TO AVOID INTERCHANGING COMPONENTS.

LOOK AND FEEL! BE SURE THE CHAMBER AND MAGAZINE ARE COMPLETELY EMPTY -- DO NOT ASSUME!!!

NEVER ATTEMPT TO DISASSEMBLE, CLEAN, OR OIL A LOADED FIREARM!

BE SURE TO READ AND UNDERSTAND ALL OF THE CAUTIONS AND WARNINGS ON ALL SOLVENTS AND CHEMICALS PRIOR TO USE. FOLLOW THE MANUFACTURER'S INSTRUCTIONS FOR BEST CLEANING RESULTS.

1. Prepare an area for cleaning the firearm with a suitable surface, adequate ventilation, correct caliber cleaning rod, brush, patches, powder solvent, and oil.
2. Remove the bolt.
3. Lay the firearm horizontally with the ejection port facing down.

ALWAYS STARTING FROM THE CHAMBER END, PUSH THE CLEANING ROD THROUGH THE BORE AND OUT THE MUZZLE END.

4. Using a small amount of powder solvent on the brush, push the cleaning rod through the barrel several times.
5. Unscrew the brush from the cleaning rod and replace it with a patch tip.
6. Push a new patch through the bore starting from the chamber end and out the muzzle.
7. Repeat the prior step (# 6) several times.
8. Push a new patch saturated with gun oil through the bore.
9. Push a new dry patch through the bore to remove the excess oil.
10. When done, always verify that the "TWO POSITION SAFETY" is operational as explained in the beginning of SECTION 2.

CHECK THE BORE CAREFULLY WHEN DONE TO BE SURE THERE ARE NO OBSTRUCTIONS (I.E. PIECES OF CLEANING PATCH, ETC.).

A VERY THIN FILM OF OIL IS SUFFICIENT PROTECTION – DO NOT OVER OIL!!!

FAILURE TO PROPERLY MAINTAIN YOUR FIREARM MAY LEAD TO DAMAGE AND/OR SERIOUS INJURY TO THE SHOOTER OR BYSTANDER.

PROTECTING METAL SURFACES

1. In order to be able to reach all surfaces, remove the bolt prior to cleaning and oiling.
2. With a soft cloth, remove any foreign matter (i.e. mud, twigs, grass).
3. Apply a thin coat of gun oil on all cleaned metal surfaces. Rubbing may be necessary to remove any signs of rust.
4. Where accessible, clean and lightly oil interior metal surfaces.
5. When done, always verify that the "TWO POSITION SAFETY" is operational as explained in the beginning of SECTION 2.

DO NOT DISASSEMBLE THE BOLT ASSEMBLY.

CHECK THE BORE CAREFULLY WHEN DONE TO BE SURE THERE ARE NO OBSTRUCTIONS (I.E. PIECES OF CLEANING PATCH, ETC.).

SECTION 9 – STATEMENT OF LIMITED WARRANTY

For your convenience, registration may now be completed directly from our web site (WWW.SAVAGEARMS.COM). Should you not have access to our web site, please complete the **WARRANTY REGISTRATION CARD** and return it to Savage Arms within ten (10) days from the date of purchase.

WHO IS COVERED?

- The original owner (with proof of purchase).

WHAT IS COVERED?

- Any defect in materials or workmanship (performed by Savage Arms) encountered during normal use.

HOW LONG IS THE WARRANTY PERIOD?

- One (1) year from the date of purchase.

WHAT IS NOT COVERED?

PERSONAL INJURY, PROPERTY DAMAGE, AND/OR DAMAGE TO THE FIREARM CAUSED BY:

- Improper maintenance or negligence to provide proper care and maintenance.
- Alterations/modifications performed without the written authorization of Savage Arms, Inc. Service Department.
- Normal wear, tear, and/or corrosion.
- Accidental discharge, careless handling, and/or misuse.
- Barrel obstructions.

EXCLUSIONS AND LIMITATIONS:

This **WARRANTY** and the remedies set forth herein are exclusive and take the place of all other expressed or implied **WARRANTIES** (including any implied **WARRANTY** of merchantability or fitness for any particular purpose which are disclaimed). No other representations or claims of any nature shall be binding on or obligate Savage Arms, Inc.

Savage Arms, Inc. excludes any incidental and consequential damages under this warranty. Some states do not allow exclusions or limitations on how long an implied warranty lasts, so the above limitations may not apply to you.

This **WARRANTY** gives you specific legal rights. You may have other rights, which will vary from state to state.

RETURNING A FIREARM:

For **WARRANTY** claims, proof of purchase must accompany the firearm.

It is a violation of Federal Law to ship a firearm with live ammunition either in the detachable box magazine, chamber, or placed in the box. For the safety of all

involved **PLEASE** be sure there is no ammunition in either the chamber, detachable box magazine, or box.

Savage Arms is not responsible for the loss or damage to any accessories shipped with the firearm.

If there is a question whether the firearm should be returned or parts could be purchased, please call 413-568-7001 between 9:00 am and 4:00 p.m. Eastern Time and ask for the Service/Warranty Department.

All firearms are to be sent to Savage Arms at the owner's expense. Warranty repairs will be returned to the owner at Savage Arms' expense.

1. Pack the firearm in its original box if possible. If a similar suitable box is used, care should be taken to protect the barrel/muzzle from breaking through. Always pack with the assumption that the firearm will undergo rough handling during transit to Savage Arms.
2. Enclose a brief note including:
 - name, address, and phone number of the sender
 - serial number of the firearm
 - description of the problem you are having
 - bullet weight, bullet type, and manufacturer of the ammunition you are using
 - any other information which you feel may be helpful.
3. Return to:
Savage Arms, Inc.
100 Springdale Road
Westfield, MA 01085
Attn: Service Department
4. If there will be a charge involved for the repair, a quote will be sent within fourteen (14) working days.
 - If there is no response from the quote within thirty (30) days, the firearm will be returned COD (\$20.00 Shipping/Handling).

Firearms will be repaired typically 3 weeks after receipt of payment in the order they were received.