

Thermal Imaging Riflescopes

THERMION 2

**Reticle
Catalogue**

Non-scalable reticles

The values of the non-scalable reticles are correct in the following cases:

- when the magnification of the scope is set to minimum
- when "picture in picture" is activated

D50i

C50i

X54i

H50i

X50i

T54i

M58i

Scalable reticles

Reticle parameters apply to all magnifications

X51Fi-300

M56Fi (Mil-Dot)

M57Fi (Mil-Dot)



D50i

Reticle parameters (for minimum magnification)

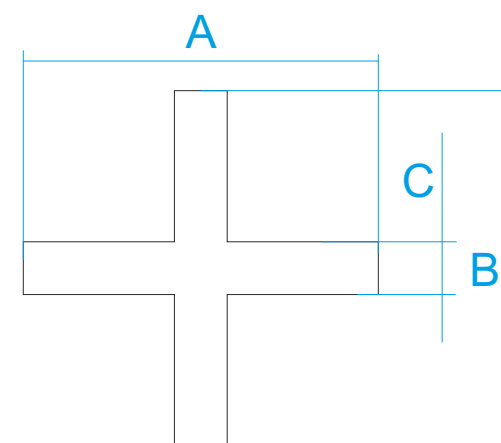

Model	MOA			cm @ 100 m		
	XQ38	XQ50	XP50	XQ38	XQ50	XP50
Section A	4.0	3.1	5.1	11.7	8.9	14.9
Section B	4.0	3.1	5.1	11.7	8.9	14.9
Section C	0.6	0.4	0.7	1.7	1.3	2.1

Thermal Imaging Riflescopes
THERMION 2

C50i

Reticle parameters (for minimum magnification)

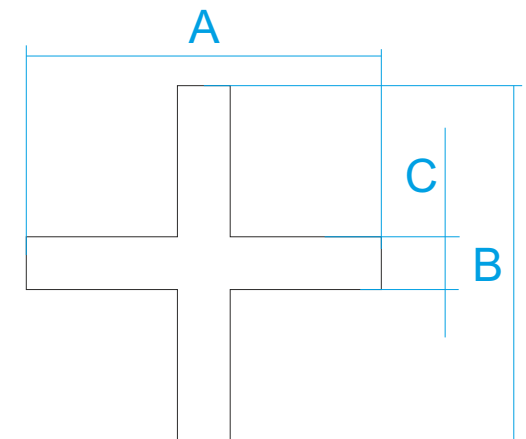
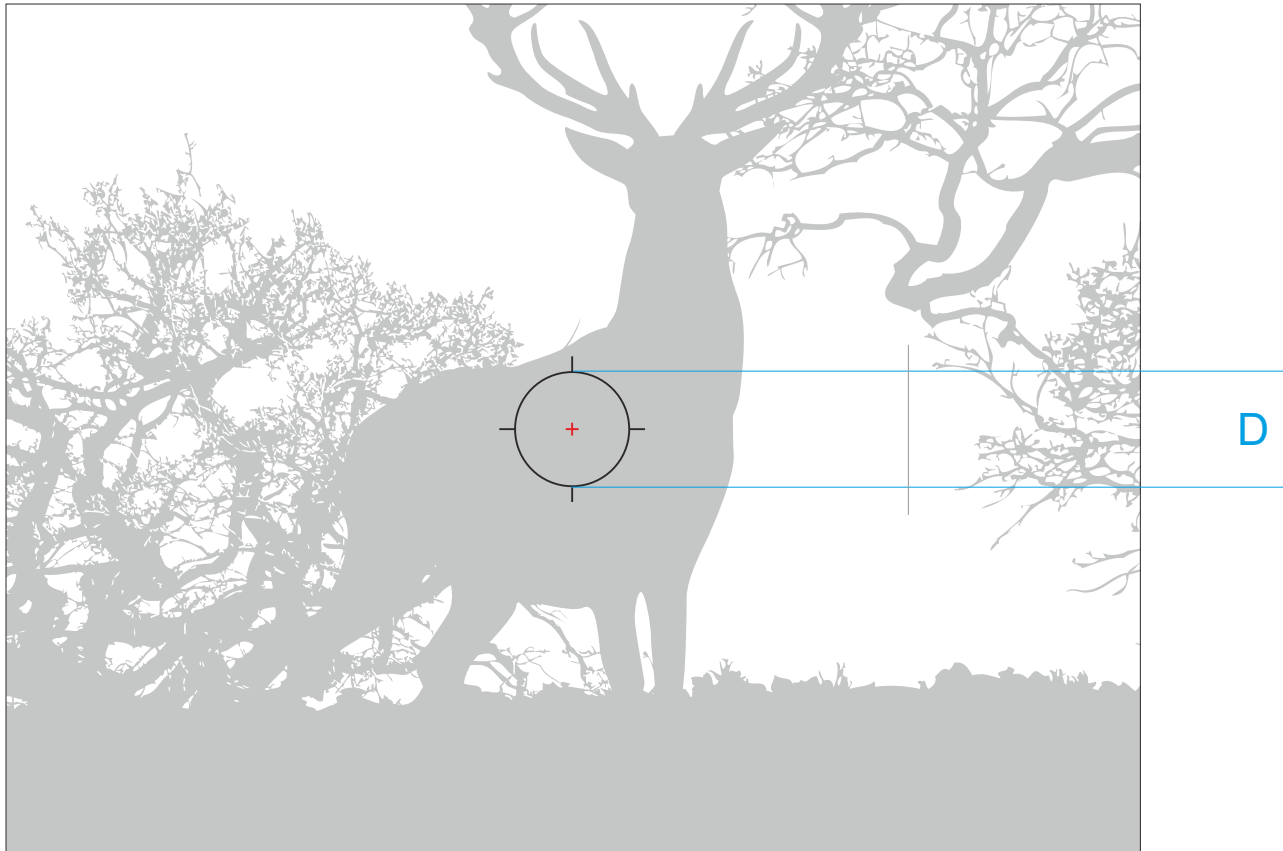

Model	MOA			cm @ 100 m		
	XQ38	XQ50	XP50	XQ38	XQ50	XP50
Section A	4.0	3.1	5.1	11.7	8.9	14.9
Section B	4.0	3.1	5.1	11.7	8.9	14.9
Section C	0.6	0.4	0.7	1.7	1.3	2.1
Section D	34.4	34.4	68.8	100	100	200

X54i

Reticle parameters (for minimum magnification)

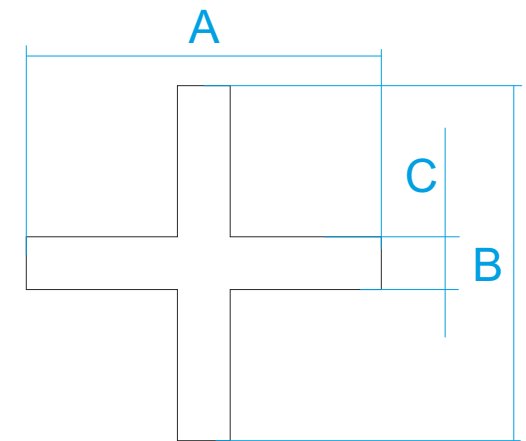
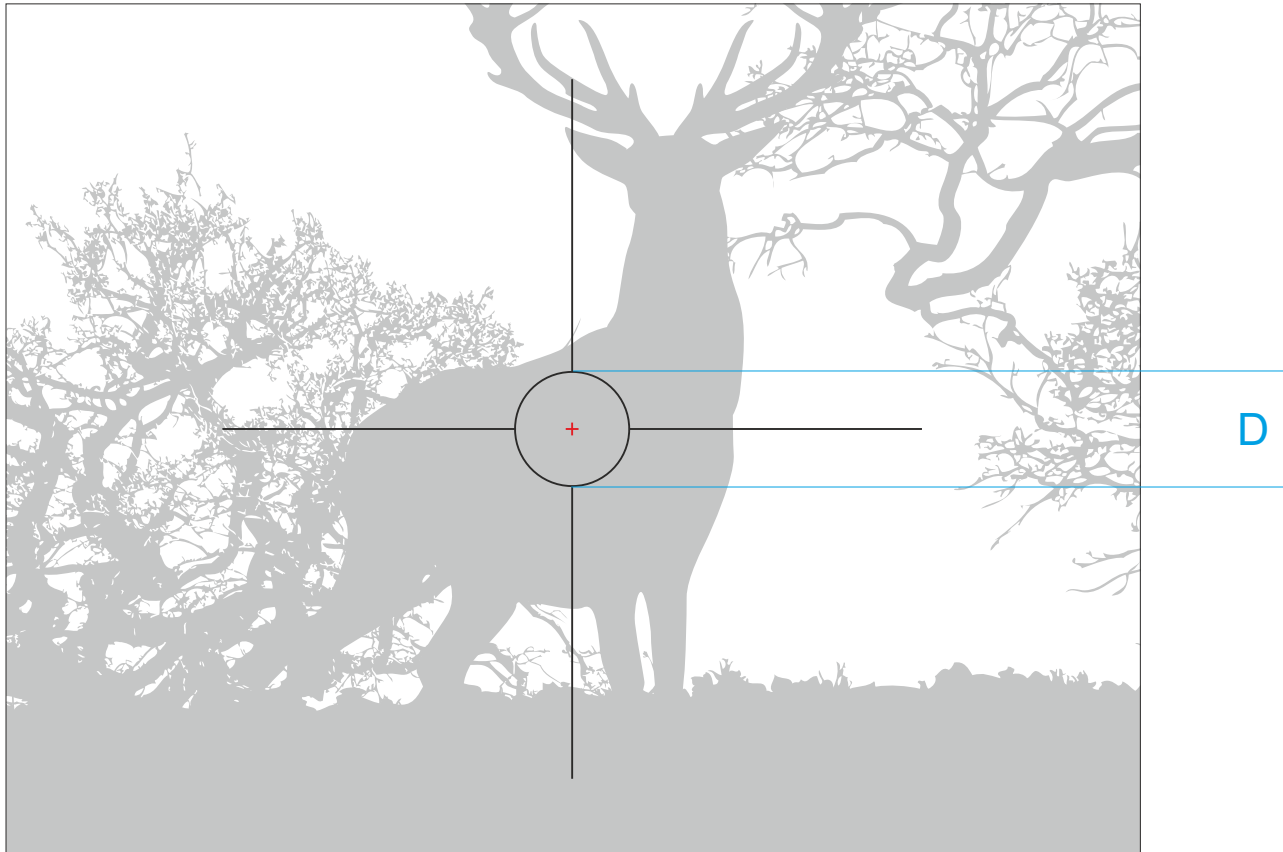

Model	MOA			cm @ 100 m		
	XQ38	XQ50	XP50	XQ38	XQ50	XP50
Section A	4.0	3.1	5.1	11.7	8.9	14.9
Section B	4.0	3.1	5.1	11.7	8.9	14.9
Section C	0.6	0.4	0.7	1.7	1.3	2.1
Section D	34.4	34.4	68.8	100	100	200

Thermal Imaging Riflescopes
THERMION 2

H50i

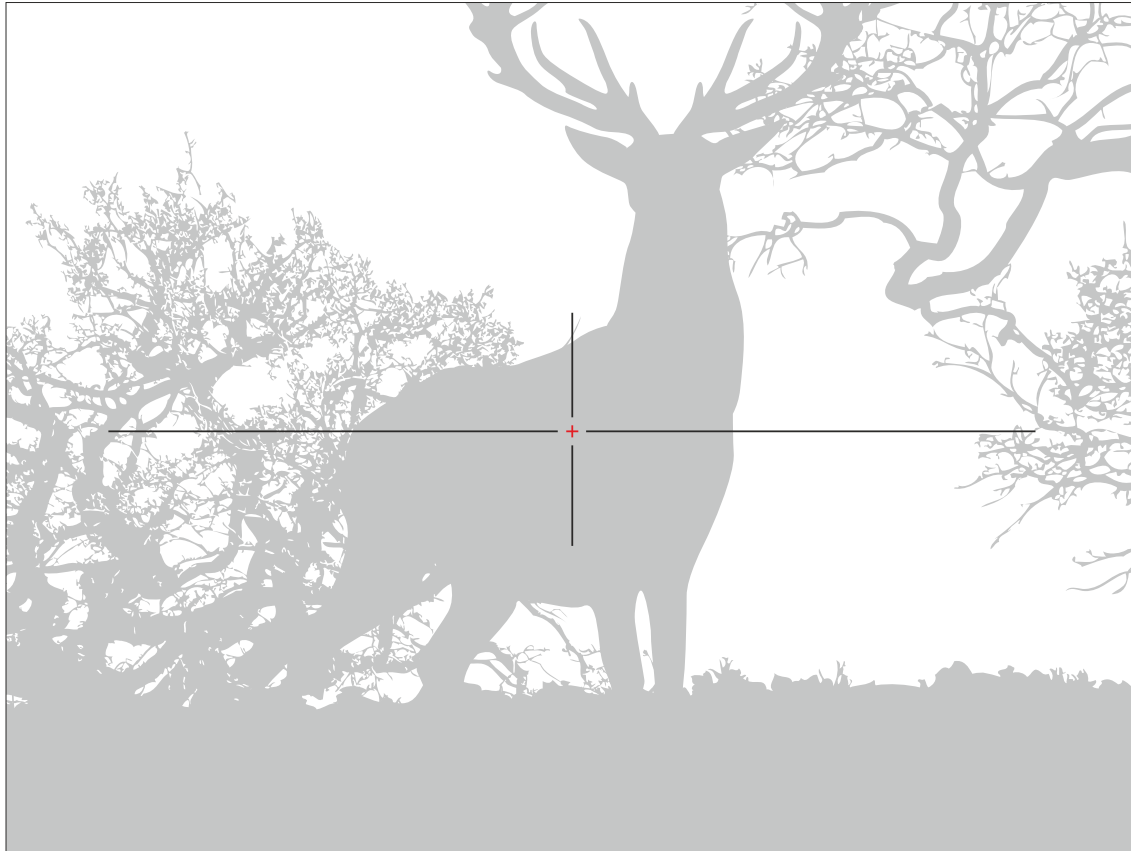

Reticle parameters (for minimum magnification)

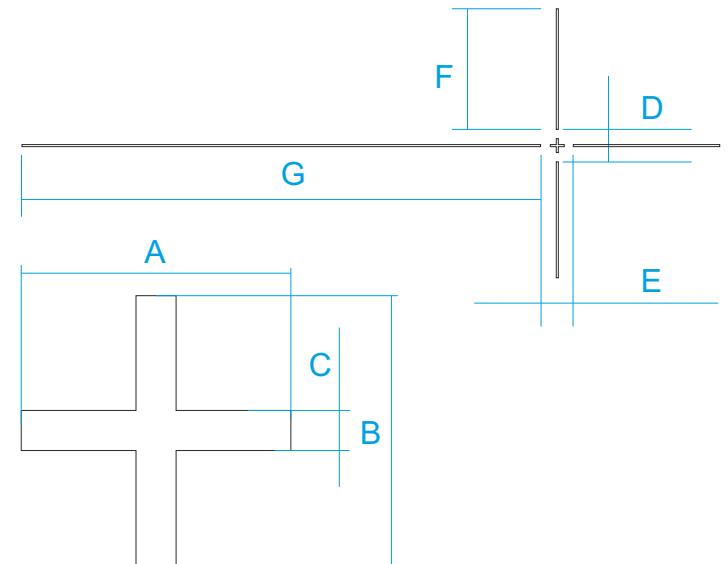

Thermal Imaging Riflescopes
THERMION 2

Model	MOA			cm @ 100 m		
	XQ38	XQ50	XP50	XQ38	XQ50	XP50
Section A	4.0	3.1	5.1	11.7	8.9	14.9
Section B	4.0	3.1	5.1	11.7	8.9	14.9
Section C	0.6	0.4	0.7	1.7	1.3	2.1
Section D	10	10	20	29	29	58
Section E	10	10	20	29	29	58
Section F	53	39.1	63.5	154	114	185
Section G	176.4	132.9	219.8	513	387	640

X50i

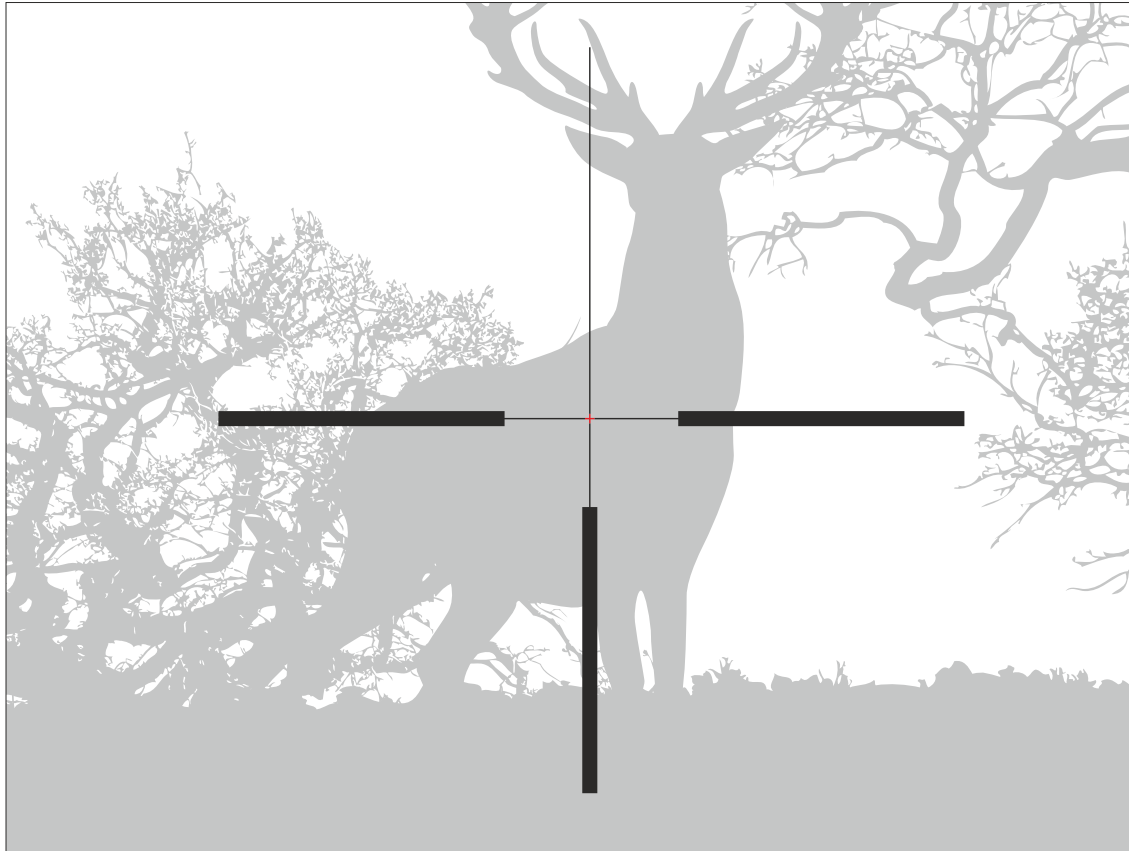

Reticle parameters (for minimum magnification)

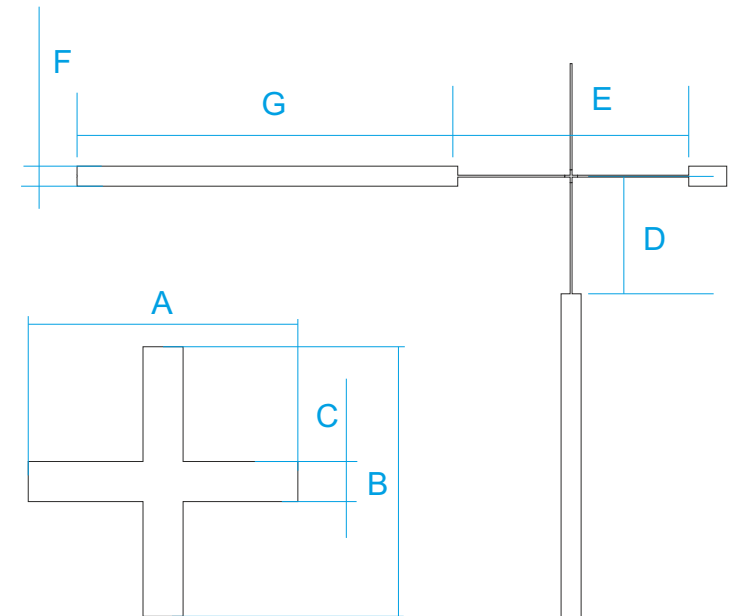

Thermal Imaging Riflescopes
THERMION 2

Model	MOA			cm @ 100 m		
	XQ38	XQ50	XP50	XQ38	XQ50	XP50
Section A	4.0	3.1	5.1	11.7	8.9	14.9
Section B	4.0	3.1	5.1	11.7	8.9	14.9
Section C	0.6	0.4	0.7	1.7	1.3	2.1
Section D	34.4	34.4	34.4	100	100	100
Section E	68.8	68.8	68.8	200	200	200
Section F	1.8	1.2	2.1	5.1	3.5	6.1
Section G	164	121	195	478	351	568

T54i

Reticle parameters (for minimum magnification)

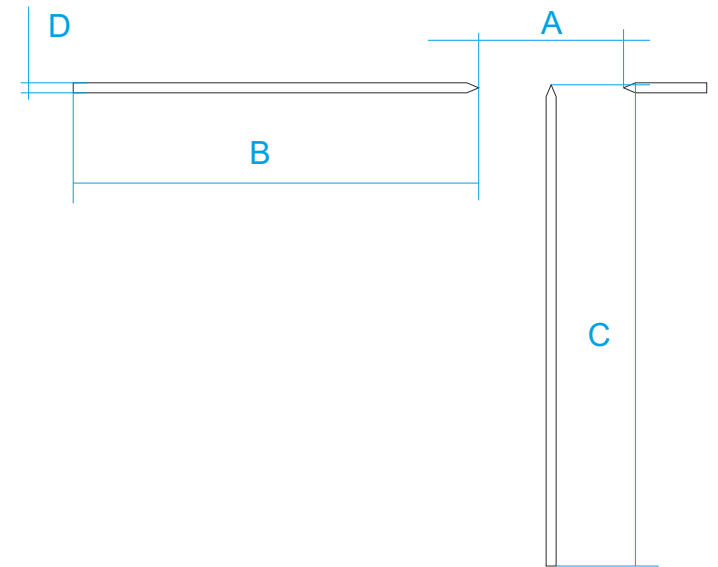

Thermal Imaging Riflescopes
THERMION 2

Model	MOA			cm @ 100 m		
	XQ38	XQ50	XP50	XQ38	XQ50	XP50
Section A	34.4	34.4	68.8	100	100	200
Section B	164	121	195	478	351	567
Section C	183	139	232	534	406	676
Section D	4.0	3.1	5.1	11.7	8.9	15

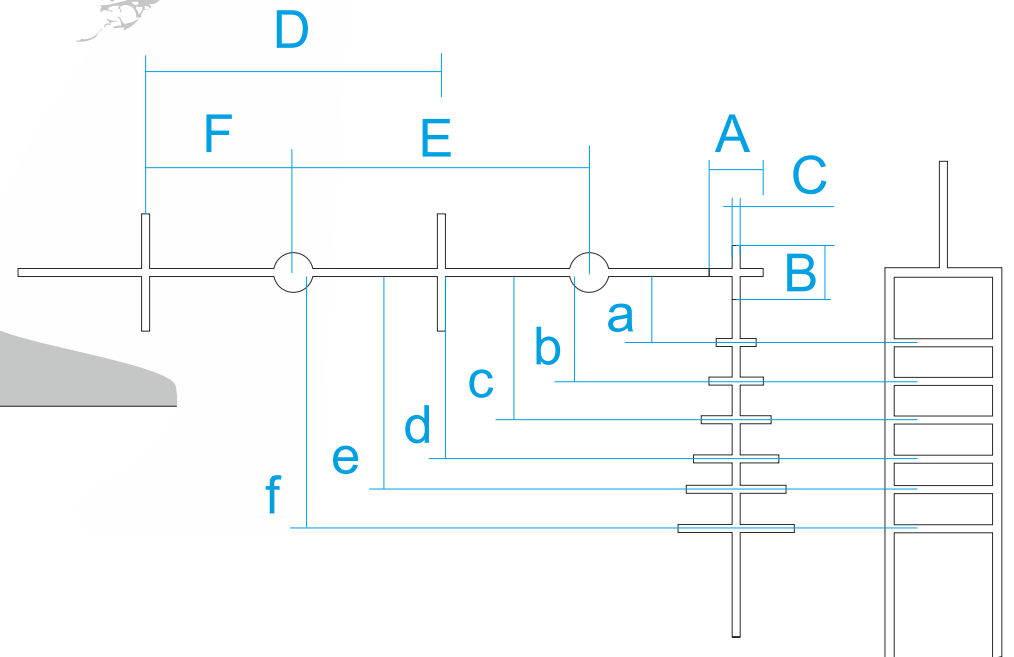
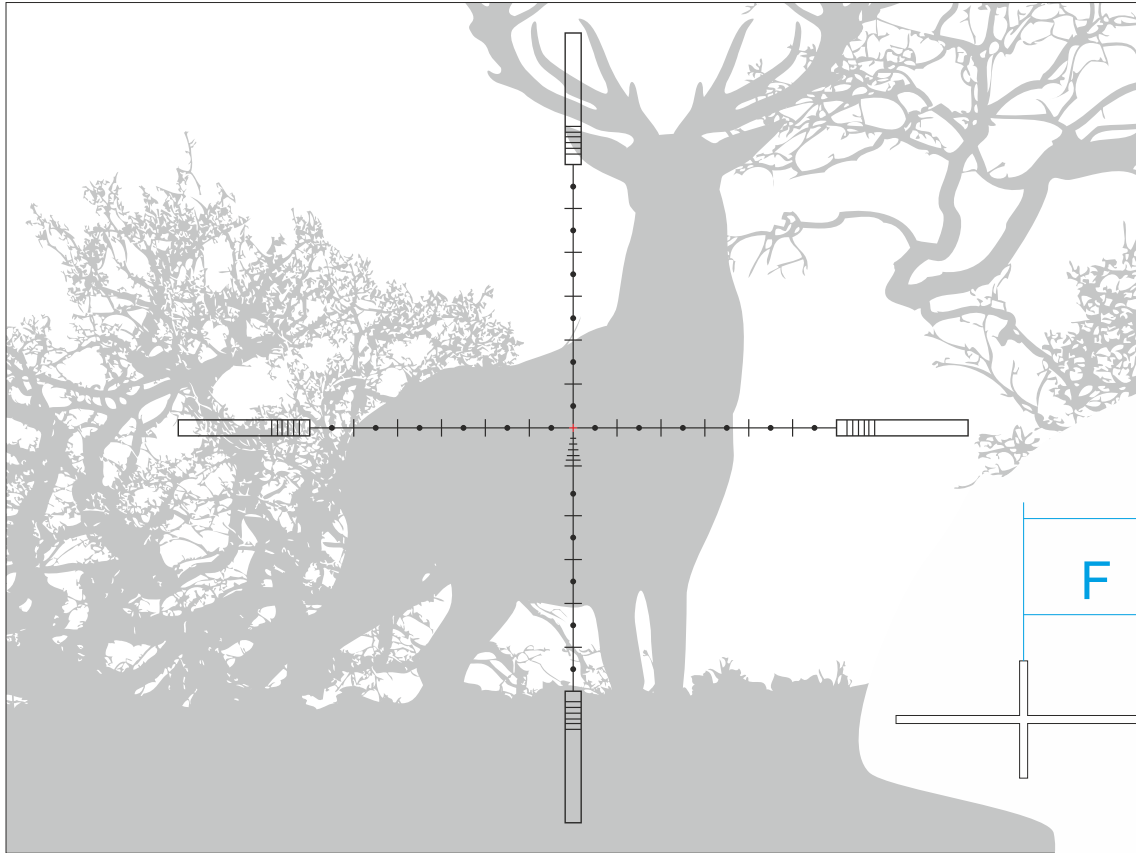

Thermal Imaging Riflescopes
THERMION 2

THERMION 2 XP50

	MOA	cm @ 100 m
Section A	5.1	14.9 On minimal magnification
Section B	5.1	14.9 On minimal magnification
Section C	0.7	2 On minimal magnification
Section D	3.5	10 (1 mil) On 16x magnification
Section E	3.5	10 (1 mil) On 16x magnification
Section F	3.5	10 (1 mil) On 8x magnification

Section a	1 mil (10 cm @ 100 m) on 2x magnification	
Section b	1 mil (10 cm @ 100 m) on 4x magnification	
Section c	1 mil (10 cm @ 100 m) on 8x magnification	
Section d	1 mil (10 cm @ 100 m) on 12x magnification	
Section e	1 mil (10 cm @ 100 m) on 16x magnification	

THERMION 2 XQ50

	MOA	cm @ 100 m
Section A	3.1	8.9 On minimal magnification
Section B	3.1	8.9 On minimal magnification
Section C	0.4	1.3 On minimal magnification
Section D	3.5	10 (1 mil) On 14x magnification
Section E	3.5	10 (1 mil) On 14x magnification
Section F	3.5	10 (1 mil) On 7x magnification

Section a	1 mil (10 cm @ 100 m) on 3.5x magnification	
Section b	1 mil (10 cm @ 100 m) on 5x magnification	
Section c	1 mil (10 cm @ 100 m) on 7x magnification	
Section d	1 mil (10 cm @ 100 m) on 10x magnification	
Section e	1 mil (10 cm @ 100 m) on 14x magnification	

THERMION 2 XQ38

	MOA	cm @ 100 m
Section A	4	11.8 On minimal magnification
Section B	4	11.8 On minimal magnification
Section C	0.6	1.7 On minimal magnification
Section D	3.5	10 (1 mil) On 10x magnification
Section E	3.5	10 (1 mil) On 10x magnification
Section F	3.5	10 (1 mil) On 5x magnification

Section a	1 mil (10 cm @ 100 m) on 2.5x magnification	
Section b	1 mil (10 cm @ 100 m) on 4x magnification	
Section c	1 mil (10 cm @ 100 m) on 5x magnification	
Section d	1 mil (10 cm @ 100 m) on 7.5x magnification	
Section e	1 mil (10 cm @ 100 m) on 10x magnification	

Reticle parameters

SCALABLE

M56Fi

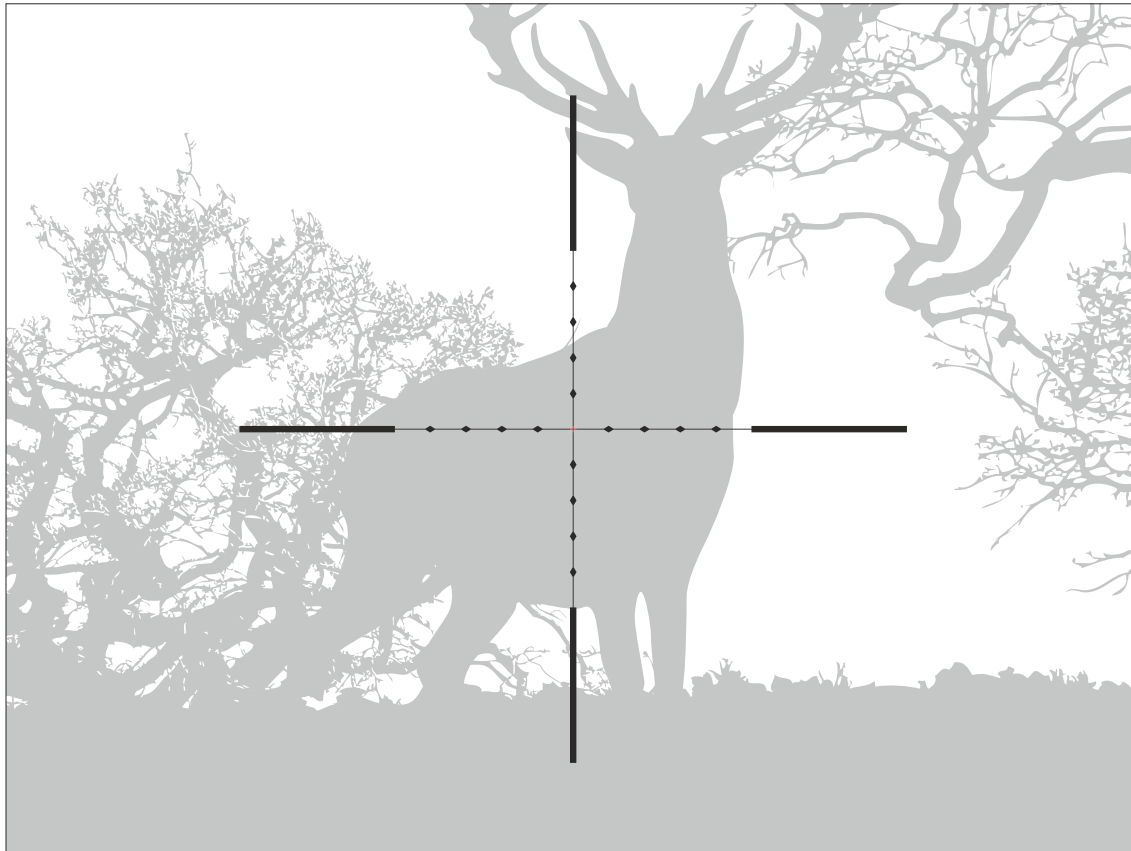

Reticle parameters (apply to all magnifications)

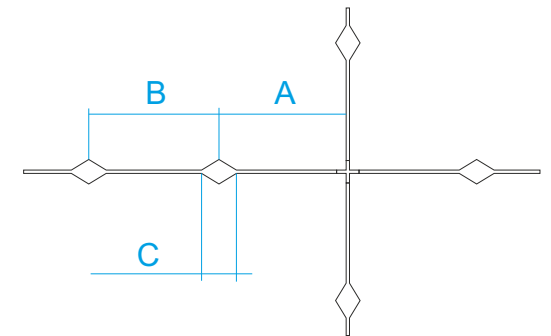

	MOA	cm @ 100 m
Section A	3.5	10 (1 mil)
Section B	3.5	10 (1 mil)
Section C	0.86	2.5 (0.25 mil)

Thermal Imaging Riflescopes
THERMION 2

SCALABLE

X51Fi-300

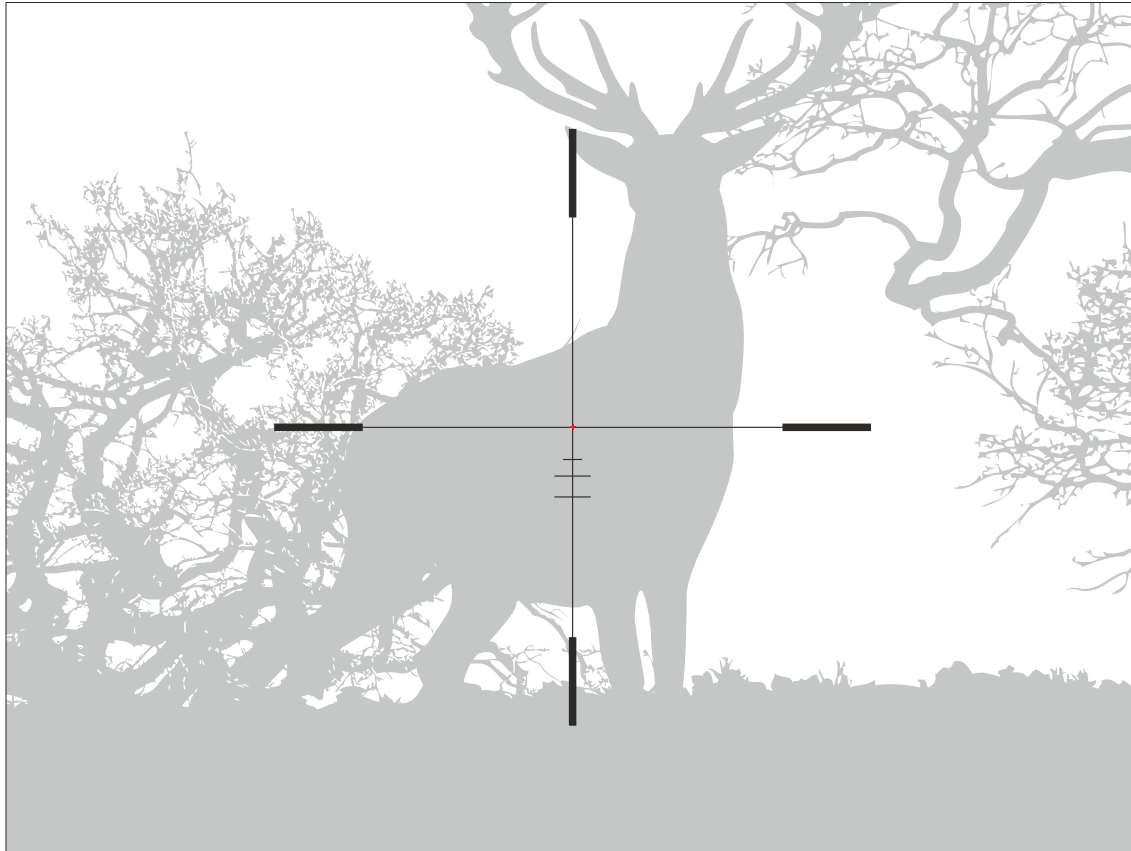

Reticle parameters (apply to all magnifications)

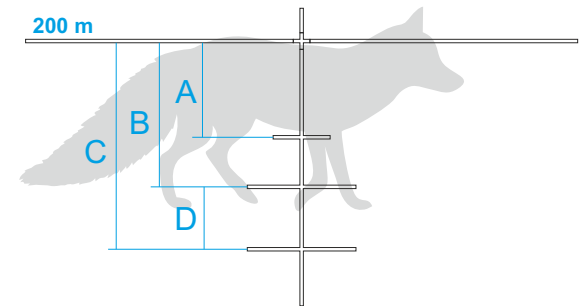

	200 m	300 m
Section A	15 cm (fox body)	23 cm (roe deer body)
Section B	23 cm (roe deer body)	35 cm (wild boar body)
Section C	35 cm (wild boar body)	50 cm (deer body)
Section D	—	15 cm (fox body)

Thermal Imaging Riflescopes
THERMION 2

SCALABLE

M57Fi

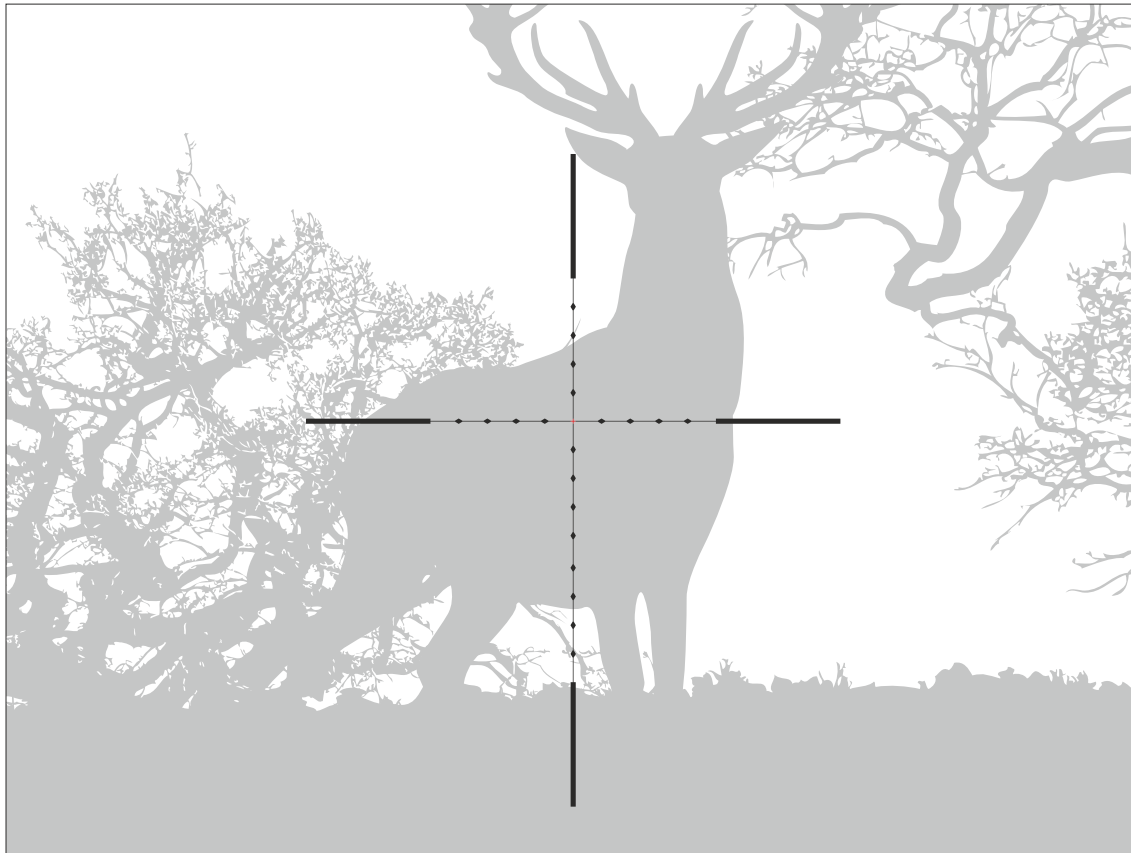

Reticle parameters (apply to all magnifications)

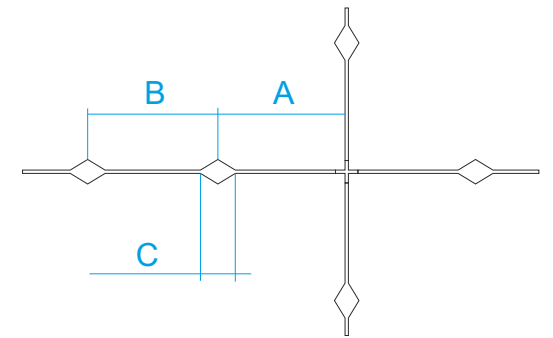

	MOA	cm @ 100 m
Section A	3.5	10 (1 mil)
Section B	3.5	10 (1 mil)
Section C	0.86	2.5 (0.25 mil)



 www.pulsar-vision.com

 @PulsarVision

 @pulsar.vision

 Pulsar Vision