

# KWA®

## kz. 61 Škorpion

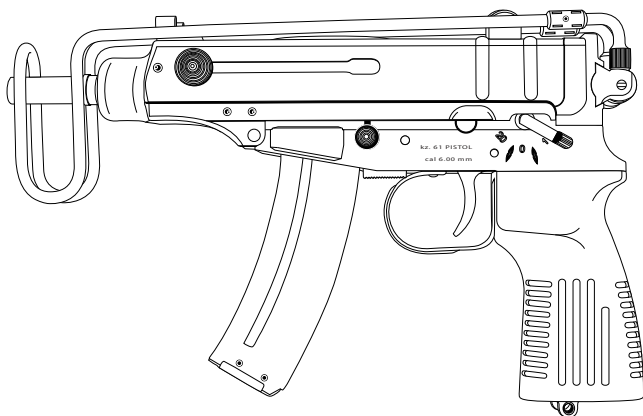

## **OPERATOR'S MANUAL**

Please read this manual carefully before using the Airsoft gun.



---

**TABLE OF CONTENTS**

Warranty Coverage .....	3-4
Use of this manual .....	5
Safety Guidelines .....	5-6
Specifications .....	7
Package Contents .....	7
Charging Gas .....	8
Selector and Safety .....	9
Loading .....	9
Shooting .....	10
Hop-Up System .....	11
Foldable Stock .....	12
Disassembly .....	12
Assembly .....	13
General Maintenance .....	13
Basic Troubleshooting .....	14
Operating Under Unusual Conditions .....	14
Diagrams and Parts Lists:	
kz. 61 Škorpion Gun .....	15-17
kz. 61 Škorpion Magazine .....	18

# KWA® WARRANTY

KWA PERFORMANCE INDUSTRIES, INC.  
18571 E. Gale Ave.,  
City of Industry, CA 91748-1339  
1-(626)-581-1777

## **THANK YOU FOR PURCHASING A KWA PERFORMANCE INDUSTRIES, INC. PRODUCT.**

KWA Performance Industries, Inc. is committed to serving our customers with the finest quality products, the highest level of service, and the best customer satisfaction. Because of this, we offer a 90-day warranty on all KWA products we import and distribute.

### **Warranty Coverage**

Except as specified below, this warranty covers all defects in material and workmanship in KWA products that occur during the above warranty period. The following are not covered by the warranty: (1) Any product which is not imported and distributed in the U.S.A. by KWA PERFORMANCE INDUSTRIES, INC. (2) Any products not purchased in the U.S.A. from a KWA AUTHORIZED RESELLER. If you are uncertain as to whether a reseller is a KWA AUTHORIZED RESELLER, please contact KWA PERFORMANCE INDUSTRIES, INC. as listed above or visit our website [www.kwausa.com/](http://www.kwausa.com/) where-to-buy (3) Damages, deterioration, or malfunction resulting from: a) An accident, act of nature, abuse, misuse, neglect, opening of or modification or failure to follow instructions supplied with the product. b) Repair or attempted repair by anyone not authorized by KWA PERFORMANCE INDUSTRIES, INC. c) Removal of the orange safety tip. (4) Use of the product outside the U.S.A. (5) Damaged batteries or improper use of bullets (BBs), or non approved propellants (ie. Propane, Red Gas, 134a...etc.) (6) Use in industrial, commercial, and/or professional applications.

### **What KWA Will Pay For**

If your KWA product is found to be defective by KWA Performance Industries, Inc. during the applicable warranty period from the date of original purchase, KWA Performance Industries, Inc. will repair, or at its option, replace with new, used, or equivalent model, the defective product without charge for parts or labor.

### **How To Obtain Warranty Service**

If your product needs service, it may be taken or shipped to KWA Performance Industries, Inc. The following procedures apply whenever your unit must be transported for warranty service:

- You must go to the Help Desk at [www.kwausa.com/support](http://www.kwausa.com/support) to obtain an RMA number. THE RMA NUMBER MUST BE CLEARLY MARKED ON THE OUTSIDE OF THE PACKAGE. PACKAGES WITHOUT AN RMA NUMBER CLEARLY MARKED WILL BE REFUSED AND RETURNED TO THE SENDER.
- You are responsible for transporting your unit or arranging for its transportation.
- If shipment of your unit is required; you must pay the initial shipping fee, but we will pay the return shipping charge if the repairs are covered by the warranty.
- WHEN RETURNING YOUR UNIT FOR WARRANTY SERVICE, A COPY OF THE ORIGINAL SALES RECEIPT MUST BE ATTACHED.
- You must include the following: RMA number, your name, address, daytime telephone number, model and serial number (if applicable) of the product and a description of the problem.

### **This Warranty is Only Valid in the United States**

If your product does not require service, but you have questions regarding its operation, please contact our Help Desk at [www.kwausa.com/support](http://www.kwausa.com/support).

THIS WARRANTY IS EXPRESSLY MADE IN LIEU OF ALL OTHER WARRANTIES, EXPRESSED OR IMPLIED, INCLUDING WITHOUT LIMITATION, WARRANTIES OF MERCHANTABILITY AND FITNESS FOR A PARTICULAR PURPOSE.

OUR LIABILITY IS LIMITED TO THE REPAIR OR REPLACEMENT, AT OUR OPTION, OF ANY DEFECTIVE PRODUCT AND SHALL IN NO EVENT INCLUDE INCIDENTAL OR CONSEQUENTIAL COMMERCIAL OR PROPERTY DAMAGES OF ANY KIND. WE ARE NOT RESPONSIBLE FOR PRODUCTS LOST, STOLEN AND/OR DAMAGED DURING SHIPPING.

SOME STATES DO NOT ALLOW LIMITATIONS ON HOW LONG AN IMPLIED WARRANTY LASTS AND/OR DO NOT ALLOW THE EXCLUSION OF INCIDENTAL OR CONSEQUENTIAL DAMAGES, THE ABOVE LIMITATIONS AND EXCLUSIONS MAY NOT APPLY TO YOU.

This warranty gives you specific legal rights, but you may also have other rights which vary from state to state. This Warranty may not be altered other than in writing signed by an officer of KWA Performance Industries, Inc.

## USE OF THIS MANUAL

Before operating the Airsoft gun, read this manual in its entirety. Important safety topics and tips are discussed throughout all of the chapters. It's important that the operator know the principles of gun handling, safety, and operation prior to firing the Airsoft gun.

## SAFETY GUIDELINES

### Safety Distance

The effective shooting range is approximately 50 feet. BBs fired from this Airsoft gun may travel further than intended. Make certain that you have an adequate backstop.

### Eye Protection

Eye protection should be worn at all times when both shooting and maintaining your Airsoft gun. Protect your eyes from BBs under pressure while performing maintenance on your Airsoft gun.

### Assume Every Gun is Always Loaded

Until you are certain the chamber is empty, treat every gun as if it were loaded. Do not assume the chamber is empty based on your memory or someone else's words. Always remove the magazine and visually check to confirm the chamber is empty.

### Beware of Barrel Obstructions

Ensure the Airsoft gun barrel is free of obstructions before you fire the gun. Even the smallest obstruction such as dirt, dust, or a stuck cleaning patch can cause a jam, misfire, or malfunction.

### Muzzle Control

Always keep the muzzle of the gun pointed in a safe direction. Never point the muzzle at a person or object that you do not intend to shoot.

### Keep Your Safety On

Keep the gun's safety on until your sights are aligned on your target and you are ready to fire.

### Keep Your Finger Off The Trigger

Keep your finger off the trigger and out of the trigger guard until your sights are aligned on your target and you are ready to fire.

### Identify Your Target and Backstop

Before you pull the trigger, make certain of your target and what is beyond it. The Airsoft gun should never be fired at surfaces such as rocks, glass, water, or other hard surfaces where BBs are likely to ricochet in unpredictable directions.



### WARNING:

- Airsoft BBs can be a choking hazard. Keep them away from children.
- Failure to follow safety guidelines may result in serious injury.

---

## SAFETY GUIDELINES (CONTINUED)

### Failure To Fire

If the Airsoft gun fails to fire, misfires, or malfunctions, do not look into the gun barrel. BBs can become lodged into the chamber, and serious eye injury may occur.

### Maintain Your Gun Properly

Performing proper maintenance, as outlined in this manual, ensures that your Airsoft gun will be safe to shoot and will perform to its designed specifications for many years. Alterations, modifications or adjustments may damage your Airsoft gun, make it unsafe to shoot, and will void all warranty claims.

### Store Your Gun Safely

Always store the Airsoft gun in a safe place, and out of reach of children. Always transport the Airsoft gun in a carrying case. Never display the Airsoft gun in a public place. Keep the safety engaged, and remove the magazine before storing the Airsoft gun.

**NOTE:** IT IS YOUR RESPONSIBILITY TO TAKE EVERY REASONABLE PRECAUTION TO ENSURE THE SAFE STORAGE AND TRANSPORTATION OF YOUR AIRSOFT GUN.

### Orange Tip

The orange tip on Airsoft guns helps Law Enforcement distinguish between the replica guns from their real firearm counterparts. Altering the coloration or markings required by state or Federal law so as to make the product look more like a firearm is dangerous and may be a crime. Operator assumes all risks and responsibility when doing so.

### Hazards of Being Mistaken for a Real Firearm

Airsoft guns have been mistaken by Police and Law Enforcement as real firearms. A confrontation with law enforcement while carrying an Airsoft gun can result in serious injury or even death. It is strongly advised to operate the Airsoft gun at a safe and legal location. In the event that you are approached by Law Enforcement personnel, you must comply with their instructions immediately to avoid an incident.

### Alcohol, Medications, and Drugs

Do not handle or operate your Airsoft gun while under the influence of alcohol, medication or drugs.

### Your Responsibility

Your Airsoft gun is well-engineered and manufactured to the highest standards. It was carefully inspected before it was packaged and shipped from our factory. Its safe use depends on you alone. You are the ultimate safety device. Like many other devices, your Airsoft gun is safe unless handled in an irresponsible or uneducated manner.



### **WARNING:**

**- Adult supervision is required for any person under the age of 18.**

## SPECIFICATIONS

- Overall Length (Retracted) = 273.05 mm [10.75"]
- Overall Length (Extended) = 517.53 mm [20.38"]
- Outer Barrel Length = 118.93 mm [4.68"]
- Inner Barrel Length = 103.50 mm [4.075"]
- Inner Barrel Diameter = 6.05 mm
- Weight = 1.266 kg [2.79 lbs]
- Caliber = 6 mm
- Magazine Capacity = 20 rounds
- Rate of Fire = 22+ RPS
- Velocity = 94-100 MPS [310-330 FPS]
- Energy Output with 0.20g BB = .89 Joules
- Gas System = New Structure 2 [NS2]
- Propellant = Green Gas

### Special Features:

- Heavy duty construction
- Ambidextrous charging handle
- Functional cocking handle with realistic bolt movement
- Foldable and removable shoulder stock
- Semi and full auto selective fire
- Type 3 adjustable hop-up

\*Individual test results may vary depending on brand of BBs, ambient temperature, and chronograph used.

## PACKAGE CONTENTS

- 1 kz. 61 Škorpion Airsoft gun
- 1 Bottle of Silicon Oil
- 1 Low Cap Magazine
- 1 Sample Bag of Airsoft BBs
- 1 Hop-Up Adjustment Tool
- 1 Operator's Manual

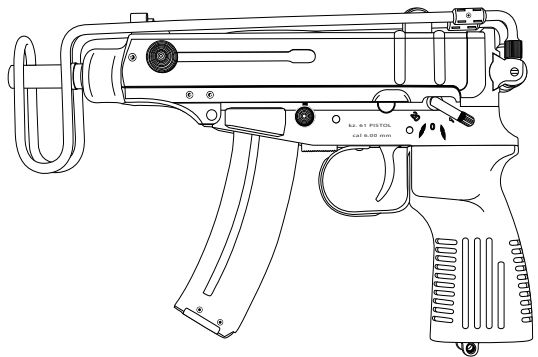



## CHARGING GAS

1. Release the magazine by pressing the magazine catch button.
2. Push the gas canister nozzle into the charging valve. (Make sure both the canister and magazine are inverted and in the vertical position when charging.)
3. Charge the magazine for approximately 10 seconds or until gas overflows from the charging valve.

**Note:** It is normal to have minor leaking from the charging valve during charging due to high pressure built up inside the magazine. It is recommended to keep the gas release valve slightly oiled. Room temperature is the ideal temperature for shooting. You may experience a delayed action if the surrounding temperature drops below 68° F.

**Note:** Do not expose the magazine to direct sunlight or incinerate the magazine, as this may cause the magazine to burst. It is strongly recommended to empty the gas from the magazine after shooting. Be certain that the gas does not make contact with eyes or skin while being released, as any contact will cause cold burns.

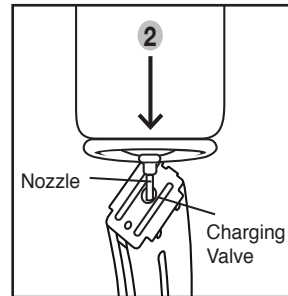
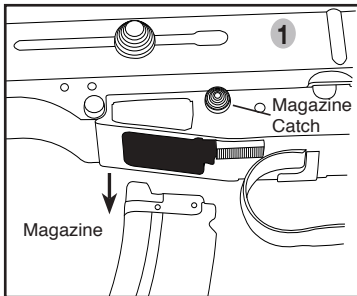

### Green Gas safety tips:

- Check the canister for any cracks or leaks before using.
- Do not expose the canister to temperature over 104° F.
- Do not leave the canister directly over fire.
- Do not heat the canister.
- Keep the canister away from direct sunlight.
- Do not leave the canister in any type of vehicle.



### WARNING:

- Avoid dropping the magazine. Sudden impact with a hard surface may cause damage to the magazine.

## SELECTOR AND SAFETY

The selector is located on the left side of the frame. Select (1) to fire semi-automatic (single shot), select (20) to fire full automatic (continuous fire) and select (0) to engage the safety.

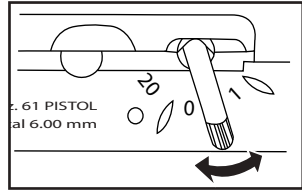

## LOADING

### LOADING BBs

1. Pull the magazine follower down until it locks.
2. Insert BBs into the magazine lip.
3. Make sure to have a 3mm clearance between BBs and the top lip of the magazine.
4. Push the magazine follower lock to release.

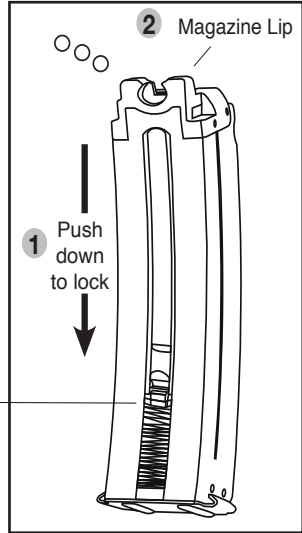
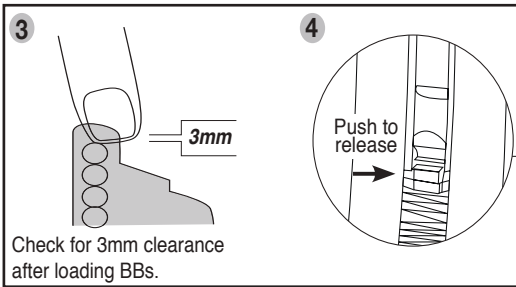

### LOADING MAGAZINE

1. Place the magazine back into the magazine well.
2. Push the magazine up until it clicks into a locked position.
3. Pull on the magazine to assure that it is locked in place.

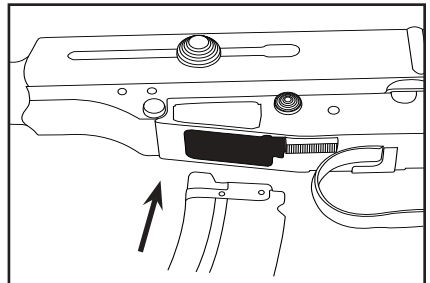

### WARNING:

- Do not release the magazine follower unless it is filled with Bb's. Doing so will damage the magazine and magazine follower.

## SHOOTING

1. Make sure the gun is cocked; Pull back on both charging handle knobs and release.
2. Grasp the Airsoft gun in your hand firmly.
3. Release safety and squeeze the trigger. The blow back action will load the following BBs automatically as the bolt cycles back and forth.

## OPEN BOLT

The bolt will remain open after the last BB has been fired. Remove the empty magazine and replace it with a loaded magazine before releasing the bolt. The first BB will be automatically loaded into the chamber.

**NOTE:** It is important to treat your gun as though it is loaded, even if the bolt remains open.

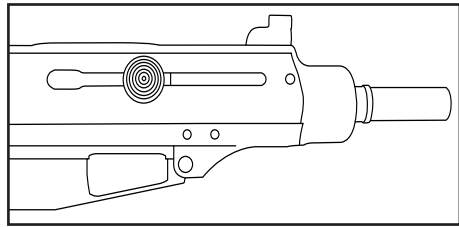

## AFTER SHOOTING

Remove the magazine then visually inspect the open bolt to check whether the chamber is clear of BBs. When the chamber is clear, **ENGAGE THE SAFETY (0)**.

**NOTE:** Keep the chamber piston and seals lightly oiled with 100% silicone oil after shooting

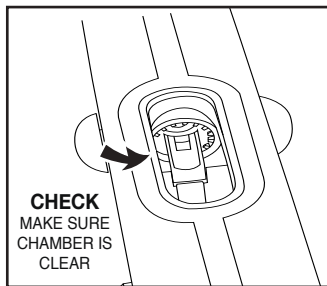

## WARNING:

- Never shoot the gun in a horizontal or upside-down position.
- Do not fire the gun without a magazine inserted. Doing so may damage the impact block and result in the loss of the impact pin.
- Always use high quality 6mm BBs, weighing 0.2g or heavier. Using recycled or low grade BBs will damage your gun.

## HOP-UP SYSTEM

The Hop-Up System is one of KWA's standard features, giving Airsoft BBs greater stability, further travel and increased accuracy. Airsoft BBs are light-weight and can be affected by wind when fired. With the Hop-Up system, the trajectory of the Airsoft BBs can be adjusted according to the shooting environment or surroundings.







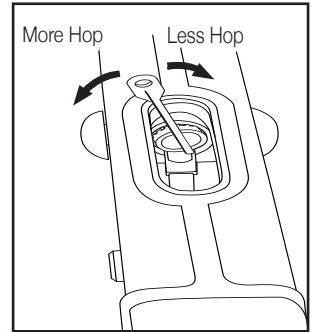



### HOP-UP ADJUSTMENT

To adjust the Hop-Up, make sure the magazine is loaded and that you have at least 65 feet of clearance for a test fire before making any adjustments.

1. Test fire the gun for 10 to 20 rounds and observe the BB's traveling pattern.
2. Remove the magazine.
3. Open the slide and place adjusting tool into the slotted chamber ring. Turn the adjusting ring a 1/8 turn at a time.
4. If the BBs are dropping too quickly, move the adjusting ring to the left or counter-clockwise to give the BB more hop. If the BBs are dropping too slowly, move the adjusting ring to the right or clock-wise.
5. Test fire and adjust as needed.



### HOP-UP ADJUSTMENT POINT

BB TRAJECTORY PATTERN		ADJUSTMENTS
	BB DROPS FREELY	 TURN KNOB TO LEFT
	BB TRAVELS AT SHORT TRAJECTORY PATH	 TURN KNOB SLIGHTLY TO LEFT
	BB TRAVELS DISTANCE AT FLAT TRAJECTORY PATH	 NO ADJUSTMENT MADE
	BB TRAVELS FLAT IN SHORT DISTANCE, THEN GOES UP IN CURVE AND DROPS FREELY	 TURN KNOB SLIGHTLY TO RIGHT
	BB TRAVELS AT UNSTABLE SPEED AND IRREGULAR PATH	 TURN KNOB TO RIGHT

## FOLDABLE STOCK

1. Pull the wire handles upward and over until it locks in place.
2. To fold the stock, press and hold the wire stock base while raising the wire stock back in place.

**NOTE:** To remove the foldable stock unit from the gun, press the plunger and slide the stock unit to the left.

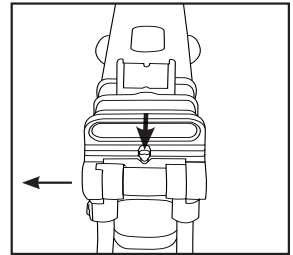
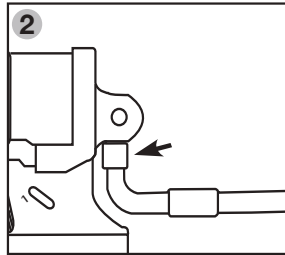
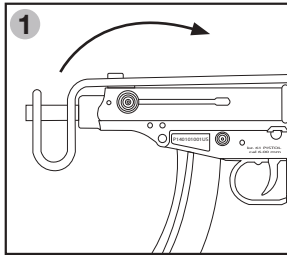

## DISASSEMBLY

It is not recommended to disassemble the gun unless for general maintenance, or to clear BBs jammed inside the barrel.

1. Remove the magazine by depressing the magazine catch.
2. Check and clear the chamber of any BBs.
3. Pull the retaining pin out from the receiver. The pin is seated tightly in the receiver.
4. Pull the upper frame upward and forward.
5. Pull the charging knobs to the rear position. Remove both "Left & Right" knobs.
6. Slide the bolt away from the upper receiver.

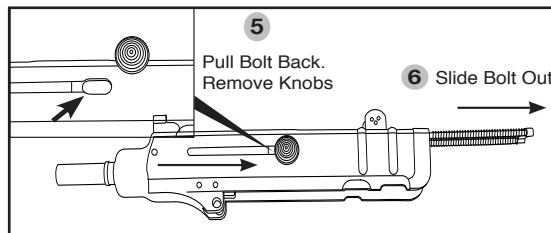
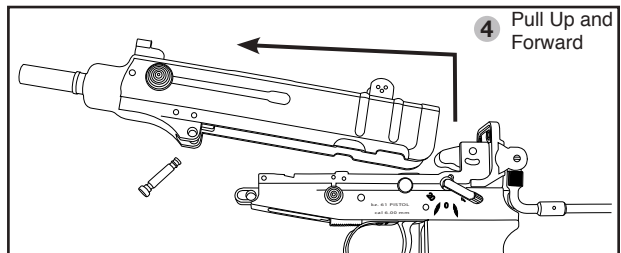
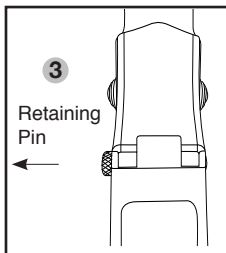

## ASSEMBLY

1. Install the bolt assembly into the upper receiver and align the bolt knob holes.
2. Push the bolt knobs into the bolt assembly, and move the bolt to the forward position.
3. Install the upper receiver onto the lower frame.
4. Align the retaining pin hole.
5. Insert the retaining pin.
6. Cycle the bolt to ensure proper assembly before shooting.

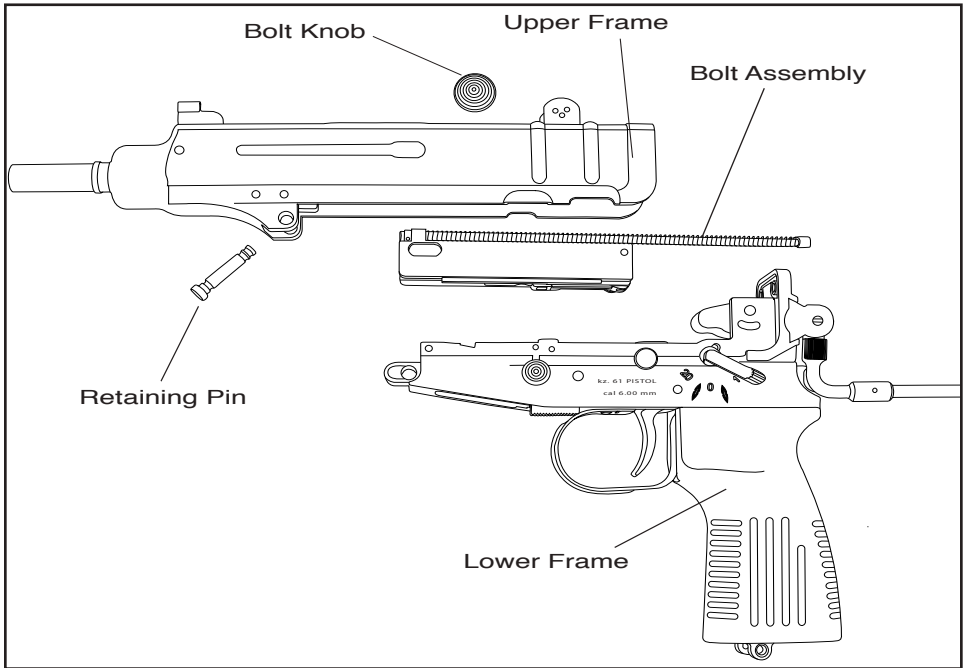

## GENERAL MAINTENANCE FOR KWA GAS BLOW BACK

Green gas is a liquid propellant which tends to dry out the seals and o-rings. Using silicone oil will extend the life of the seals and o-rings and prevent gas leaks.

Use only the recommended 100% silicone oil, available for purchase at the Airsoft dealer where you purchased your KWA products. Any other type of lubricant may damage the products.

Lightly lubricate the recoil spring, cylinder, and moving parts with a few drops of oil. Lubricating the seals and o-rings are essential. Unload BBs from the magazine. Make sure the magazine is free of gas before lubricating the magazine's charging valve and release valve.

## BASIC TROUBLESHOOTING GUIDE FOR PISTOL

SYMPTOMS	POSSIBLE CAUSE	SOLUTIONS
Slide jams / Will not complete cycle	Dry internals	Add silicone to cylinder / main seal
Double feeds BBs into chamber / BB's roll out of barrel	Hop-up adjustment too tight	Release hop-up or replace bucking
BBs will not release from magazine / bent mag lip/ check BB condition	Bent magazine lip	Replace magazine lip
Leaking release valve & charging valve	Dry O-ring	Add silicone oil to valves / Replace valves
Slide stop engages while shooting BBs	Weak slide stop spring	Adjust tension
Magazine base plate will not lock	Broken base plate lock	Replace base plate lock
Magazine base leaking air	Worn out base seal	Replace magazine base seal
Cylinder will not load BBs into chamber	Broken cylinder tab	Replace cylinder
Trigger will not reset	Worn out trigger spring / trigger bow spring	Replace trigger spring / trigger bow spring

## OPERATING UNDER UNUSUAL CONDITIONS

Unusual conditions are defined as any condition requiring special maintenance. Perform maintenance outlined for the climate similar to your operational area.

### Extreme Cold:

Operating an Airsoft gas gun in extremely cold temperatures is not recommended. Cold temperatures will cause the Hop-up Bucking to harden, reducing its effectiveness. Gas will not expand properly in cold temperatures, so both the cycling rate and power will be dramatically reduced.

### Extreme Heat:

Operating an Airsoft gas gun in extremely hot temperatures is also not recommended. Leaving the gun in direct sunlight for long periods of time, or operating in extremely hot areas will cause the gas to over-expand, damaging the internal workings of the gun. The increase in internal pressure from the expanding gas can also damage the seals and cause leaks in the magazine.

### Dust or Sand:

Dust or sand can get into a gas gun and cause malfunctions and/or excessive wear. Keep the gun covered whenever possible. Use lubricant sparingly, as lube naturally attracts dirt and other particles. After use in a dusty area, always field strip the gun (refer to Disassembly Section) and clean any areas you can reach with a soft, lint-free cloth.





## kz. 61 Škorpion PARTS LIST

Parts #	Description
KZ.61-001	GRIP
KZ.61-002	RECOIL GUIDE BRACKET
KZ.61-003	CYLINDER
KZ.61-004	INNER BARREL CLAMP
KZ.61-005	HOP-UP CYLINDER CLAMP
KZ.61-006	JET NOZZLE
KZ.61-009	OUTER BARREL
KZ.61-010	UPPER RECEIVER
KZ.61-011	FRAME
KZ.61-012	OUTER BARREL BASE
KZ.61-013	BOLT
KZ.61-014	REAR SIGHT HOUSING
KZ.61-015	REAR SIGHT BLADE
KZ.61-016	WIPE STOCK MOUNT
KZ.61-017	WIPE STOCK ARM (LEFT)
KZ.61-018	WIPE STOCK ARM (RIGHT)
KZ.61-019	HOP-UP CYLINDER
KZ.61-020	CHARGING KNOBS
KZ.61-021	BOLT BREECH
KZ.61-022	BB FEED RAMP
KZ.61-023	BOLT CATCH
KZ.61-024	MAGAZINE CATCH
KZ.61-025	BOLT LOCK BUTTON
KZ.61-026	IMPACT BLOCK
KZ.61-027	IMPACT BLOCK BASE
KZ.61-028	IMPACT BASE EXTENSION BASE
KZ.61-029	IMPACT BLOCK RESET

Parts #	Description
KZ.61-030	HAMMER
KZ.61-031	HAMMER SPRING GUIDE
KZ.61-032	HAMMER SPRING CYLINDER
KZ.61-033	SEAR
KZ.61-034	TRIGGER
KZ.61-035	DISCONNECTOR
KZ.61-036	SAFETY LEVER
KZ.61-037	RECOIL BUFFER
KZ.61-038	UPPER RECEIVER BACK PLATE
KZ.61-039	FRONT SIGHT POST
KZ.61-040	FRONT SIGHT HOUSING LOCK
KZ.61-041	RECOIL SPRING RETAINER X2
KZ.61-042	BOLT RETURN SPRING GUIDE X2
KZ.61-043	REAR SIGHT BLADE PIN
KZ.61-044	REAR SIGHT BLADE PLUNGER
KZ.61-045	INNER BARREL CLAMP
KZ.61-046	JET NOZZLE PIN
KZ.61-047	RECOIL BUFFER PIN
KZ.61-048	WIPE STOCK MOUNT PLUNGER
KZ.61-049	STOCK MOUNT SPRING CAP
KZ.61-050	WIPE STOCK ARM PIN
KZ.61-051	WIPE STOCK ARM LOCK PIN
KZ.61-052	WIPE STOCK ROLL PIN X2
KZ.61-053	FEED RAMP PINS X2
KZ.61-055	TAKE DOWN PIN
KZ.61-056	BOLT CATCH SPRING
KZ.61-057	IMPACT BLOCK PIN

Parts #	Description
KZ.61-058	EXTENSION SPRING LOCK PIN
KZ.61-059	IMPACT EXTENSION PIN
KZ.61-060	IMPACT HOUSING PIN
KZ.61-061	BOLT LOCK
KZ.61-062	HAMMER PIN
KZ.61-063	HAMMER SPRING GUIDE PIN
KZ.61-064	HAMMER SLEEVE
KZ.61-065	LOCK PLUNGER X4
KZ.61-066	HAMMER STOP PIN
KZ.61-067	HAMMER SPRING CYLINDER PIN
KZ.61-068	SEAR PIN
KZ.61-069	DISCONNECTOR PLUNGER
KZ.61-070	GRIP BOLT PLUNGER
KZ.61-071	GRIP BOLT
KZ.61-072	GRIP BOLT NUT SPRING GUIDE
KZ.61-073	GRIP BOLT NUT
KZ.61-074	GRIP BOLT SPACER
KZ.61-075	MOCK PIN INSERT X2
KZ.61-076	MAIN SEAL BASE
KZ.61-077	TRIGGER SLEEVE
KZ.61-079	HOP-UP BUCKING SLEEVE
KZ.61-080	MAIN SEAL CAP
KZ.61-081	MAIN SEAL BASE SCREW
KZ.61-082	HAMMER RESET BLOCK PIN
KZ.61-083	BOLT RETURN SPRING X2
KZ.61-084	REAR SIGHT BLADE SPRING
KZ.61-085	BOLT CATCH SPRING

## kz. 61 Škorpion PARTS LIST (CONTINUED)

Parts #	Description
KZ.61-114	HOP-UP BUCKING
KZ.61-115	OUTER BARREL BASE PIN
KZ.61-116	BREECH PIN
KZ.61-117	REAR SIGHT BASE SCREW X2
KZ.61-118	MAIN SEAL CAP SCREW
KZ.61-119	RECOIL GUIDE RETAINER PIN X2
KZ.61-120	DISCONNECTOR PIN
KZ.61-121	LOCK BUTTON PIN
KZ.61-123	GRIP LOCK WASHER
KZ.61-124	HOP-UP TENSIONER CLAMP
KZ.61-125	FRONT SIGHT POST O-RING
KZ.61-126	FEED RAMP PIN O-RING X2
KZ.61-127	FRONT SIGHT ADJUSTMENT TOOL

Parts #	Description
KZ.61-086	IMPACT BLOCK SPRING
KZ.61-087	IMPACT BASE EXTENSION SPRING
KZ.61-088	MAGAZINE CATCH SPRING
KZ.61-089	BOLT LOCKING SPRING
KZ.61-090	HAMMER SPRING
KZ.61-091	HAMMER LOCK PLUNGER SPRING X2
KZ.61-092	DISCONNECTOR SPRING
KZ.61-093	GRIP BOLT SPRING
KZ.61-094	WIPE STOCK MOUNT PLUNGER SPRING
KZ.61-095	WIPE STOCK ARM SPRING
KZ.61-096	TAKE-DOWN PLUNGER SPRING
KZ.61-097	IMPACT BLOCK RESET SPRING
KZ.61-098	IMPACT BLOCK BASE SPRING
KZ.61-099	HOP-UP TENSIONER
KZ.61-100	JET NOZZLE SPRING
KZ.61-101	CYLINDER RETURN SPRING
KZ.61-104	FRONT SIGHT HOUSING
KZ.61-105	TRIGGER BAR
KZ.61-106	INSERT LEVER
KZ.61-107	TRIGGER HOUSING
KZ.61-108	HAMMER PIN LOCK
KZ.61-109	TRIGGER GUARD
KZ.61-110	WIPE STOCK
KZ.61-111	HAMMER RESET BLOCK
KZ.61-113	MAIN SEAL

## kz. 61 Škorpion MAGAZINE PARTS LIST

Parts #	Description
KZ.61-129	MAGAZINE LIP
KZ.61-130	MAGAZINE BODY
KZ.61-131	MAGAZINE FOLLOWER
KZ.61-132	MAGAZINE BASE
KZ.61-133	MAGAZINE BASE PLATE LOCK
KZ.61-134	MAGAZINE FOLLOWER LOCK
KZ.61-136	MAGAZINE LIP PINS X2
KZ.61-137	MAGAZINE BASE PINS X2
KZ.61-138	MAGAZINE EXPANSION TUBE
KZ.61-140	MAGAZINE BASE PLATE
KZ.61-142	MAGAZINE LIP NOZZLE SEAL
KZ.61-143	MAGAZINE BASE SEAL
KZ.61-145	MAGAZINE FOLLOWER SPRING
KZ.61-146	MAGAZINE FOLLOWER LOCK SPRING
KZ.61-148	MAGAZINE RELEASE VALVE
KZ.61-149	MAGAZINE CHARGING VALVE

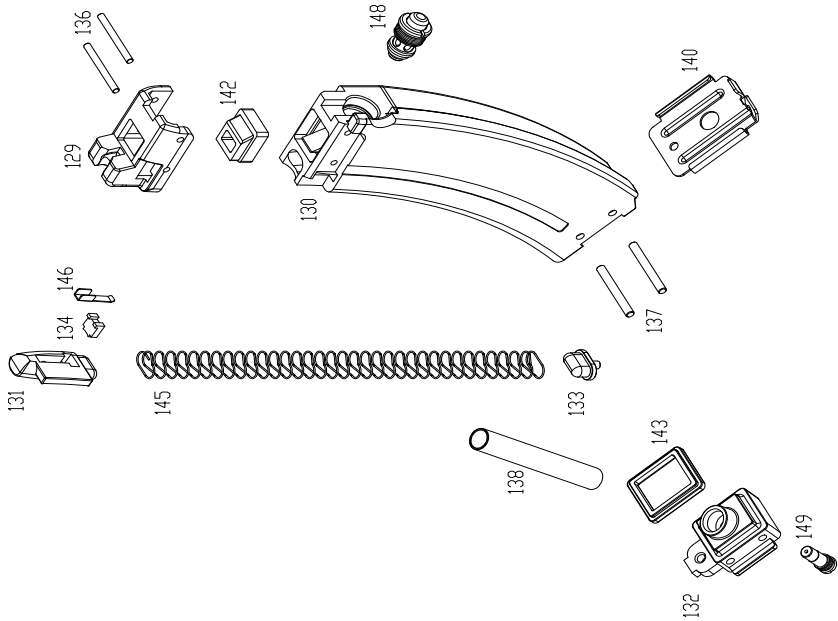

**KWA Performance Industries, Inc.**

18571 E. Gale Ave  
City of Industry, CA 91748

T: 1.626.581.1777 • F: 1.626.581.0777

[WWW.KWAUSA.COM](http://WWW.KWAUSA.COM)