



HATSAN
ARMS COMPANY

Serious. Solid. Impact.



BT65 SERIES PCP AIR RIFLE

INSTRUCTION MANUAL

PLEASE READ THIS MANUAL BEFORE USING YOUR AIR GUN

Thank you for choosing HATSAN BT65 PCP air rifle.

Always use caution when operating this rifle. Learn and obey the laws of your state and/or country, and be responsible in your use of this air rifle. Please read this manual completely before handling or shooting your air gun. It's the sole responsibility of the user to use this air gun properly and safely.

Your air rifle contains many features which gives greater handling, greater accuracy and enjoyment:

- Dovetail groove receiver for both 11mm and 22mm scope mounts.
- Overall blued finish
- Precision rifled steel barrel for accuracy
- Manual Safety
- Synthetic or wooden stock all with elevation adjustable comb
- Stock length of pull and stock fit adjustable rubber recoil pad
- Adjustable rear & front sight with fiber optic.
- Quattro Trigger: 2-stage full adjustable match trigger for trigger travel and trigger load.
- Metal trigger
- Detachable air cylinder tube enabling to use spare air cylinders
- Built-in pressure gauge to monitor the cylinder pressure
- Standard quick-fill nozzle & air cylinder discharging cap
- 10 shot magazine (9 shot in .25 / 6.35mm caliber)
- Side bolt or rear bolt action

Warning!

1. Each HATSAN BT65 PCP air rifle contains pressurized air and should only be dismantled by a competent gunsmith. Do not attempt to dismantle the rifle if the rifle is partially or fully charged, except for removal and replacement of the air cylinder. Serious injury and/or damage may result if this instruction is ignored.

Never shoot the rifle when the air cylinder is removed or empty. Otherwise serious damage/injury/death may be caused on you or others and also your air rifle may get damaged. Never attempt to dismantle the air cylinder parts or air gauge when the air cylinder is fully or partially charged. Serious injury/death/damage may result if this instruction is ignored because of the pressurized air in the air cylinder.

2. Use only factory manufactured waisted pellets that are no longer than the thickness of the rifle's magazine. Do not use BB ammunition with your rifle.

3. HATSAN BT65 PCP air rifle is designed specifically for use with dry compressed air. NO OTHER GAS OR GAS COMBINATION MUST BE USED.

The rifle may be filled from a diver's bottle, a suitable compressor or by using a hand pump specifically made to fill pre-charged air guns.

MAXIMUM SAFE WORKING PRESSURE (SWP) : 200 BAR.

RECOMMENDED FILL PRESSURE : 190 BAR

GENERAL INSTRUCTIONS

BT65 series may have rear & front sight assembled at factory. If not, you should mount Scopes and other alternate optic sights before use. Scopes and other alternate optic sights can also be mounted on BT65 having rear & front sight.

Before using your new air rifle check if it is fully charged and abide the below basic safety rules:

Basic Safety Rules:

1. Treat every rifle as if it is loaded.
2. Never point the rifle at anyone, or allow anyone to point a rifle at you, even if you know it is not loaded.
3. Always carry the rifle so that the direction of the muzzle is under control, even if you stumble.
4. Always be sure of your target and what lies behind it before firing your rifle.
5. Never leave a loaded rifle unattended.
6. Beware of targets that tend to cause ricochets.
7. It is compulsory for the user and bystanders to wear eye & ear protection when charging the air cylinder and when shooting.

Section I. SPECIFICATIONS

BT65 is a 10 shot (9 shot in .25 / 6.35mm caliber), pre-charged, manual loading, pneumatic air rifle with detachable air cylinder tube (255cc)

It is available .177 (4.5mm), .22 (5.5mm) and .25 (6.35mm) caliber.

Barrel Length	585mm / 23"
Overall Length	1085mm / 42.7"
Weight	4.3kg / 9.4lbs
Maximum cylinder fill pressure	200 Bar

Maximum Muzzle Velocity/Energy:

1250fps (380m/s) in cal. .177 (4.5mm), Energy 40Joules / 30ft.lbs

1180fps (360m/s) in cal.22 (5.5mm), Energy 61Joules / 45ft.lbs

1090fps (330m/s) in cal.25 (6.35mm), Energy 71Joules / 52ft.lbs

* Above maximum muzzle velocity figures may differ depending on the pellet weight & shape.

* The energy restriction of a particular country can be achieved by the reduction in the muzzle velocity. The above maximum velocity figures are obtained when there is no energy restriction on the air rifle and when measured at optimum pressure value in the air tube. As a nature of PCP air rifles the velocity starts low at maximum pressure level in the air tube, then starts to increase and gets to the maximum at optimum pressure value in the air tube; and then it starts to decrease again as the pressure in the air cylinder gets too low.

Section II. BASIC PARTS OF YOUR GUN

Side Bolt Version

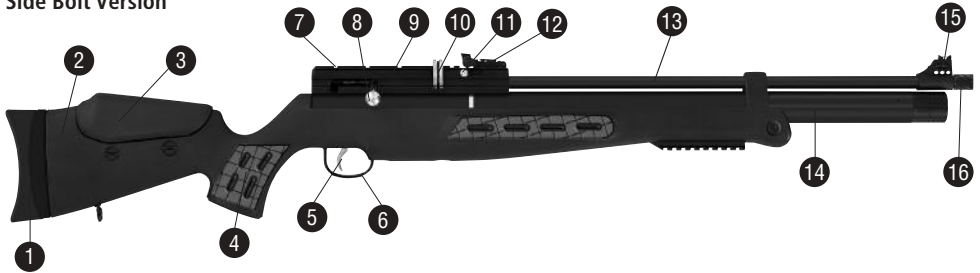

- | | | | |
|--------------------|---------------------|---------------------------|-----------------------|
| 1. Butt Pad | 5. Trigger | 9. Receiver | 13. Barrel |
| 2. Stock | 6. Trigger Guard | 10. Magazine | 14. Air Cylinder Tube |
| 3. Adjustable Comb | 7. Scope Rail | 11. Magazine Release Bolt | 15. Front Sight |
| 4. Grip | 8. Side bolt Handle | 12. Rear Sight | 16. Muzzle Cap |

Rear Bolt Version

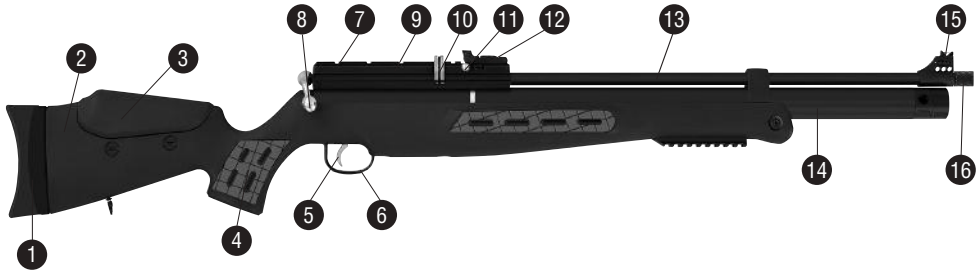

- | | | | |
|--------------------|---------------------|---------------------------|-----------------------|
| 1. Butt Pad | 5. Trigger | 9. Receiver | 13. Barrel |
| 2. Stock | 6. Trigger Guard | 10. Magazine | 14. Air Cylinder Tube |
| 3. Adjustable Comb | 7. Scope Rail | 11. Magazine Release Bolt | 15. Front Sight |
| 4. Grip | 8. Rear bolt Handle | 12. Rear Sight | 16. Muzzle Cap |

Section III. MANUAL SAFETY

Safety button can be set to 'ON' and 'OFF' position manually.

- To set the safety to 'ON', pull safety button. In this position, the trigger cannot be pulled and the gun cannot be fired. (Fig. 1)
- To remove the safety to 'OFF', push safety button. In this position, the gun is ready to shoot. (Fig. 2)

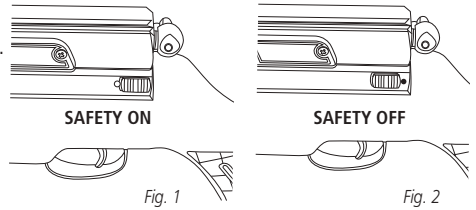

CAUTION: Until you are actually ready to shoot, keep the safety button in the "ON" position (Fig. 1).

Section V. QUATTRO TRIGGER

Your air rifle is equipped with Quattro trigger, (Fig. 3), you can adjust "trigger travel" & "trigger pull" as follows:

BOLT#1 is for trigger pull force adjustment. For less trigger pull force prior to discharge, rotate BOLT #1 clockwise; and vice versa.

BOLT#2 is for trigger travel adjustment. For less trigger travel prior to discharge, rotate BOLT #2 clockwise; and vice versa.

BOLT#3 is for adjusting the trigger force to pull the trigger till the end of 1st stage. When this is turned clockwise, this force increases; and vice versa.

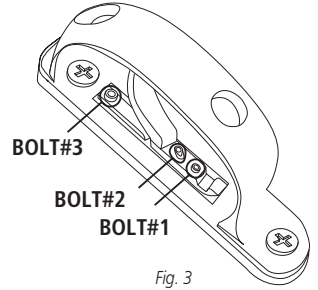

Section VI. MICRO ADJUSTABLE REAR-SIGHT & ADJUSTABLE FRONT SIGHT

Your air rifle come with fiber optic rear & front sight fitted-except on models with fixed noise-dampener whereas you should fit a scope or other alternate optic sights..

The rear-sight is a sensitive device and can be adjusted both for elevation and windage.

Windage adjustment

- If the shot is deflected to the left of the target, turn the KNOB1 clockwise. (Fig. 4)
- If the shot is deflected to the right of the target, turn the KNOB1 counter-clockwise. (Fig. 4)

Elevation adjustment

- If the shot is too high, turn KNOB2 clockwise. (Fig. 4)
- If the shot is too low, turn KNOB2 screw counter-clockwise. (Fig. 4)

Further elevation adjustment is possible by means of the adjustable front sight.

- If the shot is too high, turn KNOB3 clockwise. (Fig. 5)
- If the shot is too low, turn KNOB3 counter-clockwise. (Fig. 5)

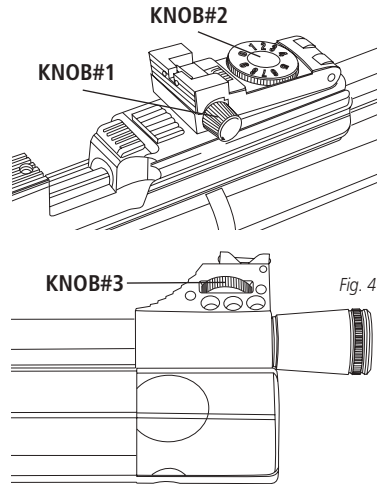

Section VI. OPERATING INSTRUCTIONS

Warning!

1. Before filling the air cylinder; make sure the air rifle is not cocked, safety is at ON position, no pellets are loaded in the air rifle and/or barrel and magazine is not mounted on the gun. If air cylinder is completely empty; the cocking handle should be pulled back and kept at open position in order fill air into the air cylinder.
2. Take all safety measures before filling the air cylinder. It is compulsory for the user and bystanders to wear eye & ear protection when filling the air cylinder.
3. While filling in the air cylinder; the pressure in the air cylinder must be monitored from the air gauge of the hand pump or scuba charging kit. Do not look thru the air gauge on the air cylinder during filling process of the air cylinder.

Charging the Rifle

Fit the filler nozzle to the air-line of the charging equipment, which must incorporate a pressure gauge. Ensure both filler nozzle and rifle filler hole are clear from dirt and push the nozzle into the filler hole. Fill the rifle to the cylinder pressure quoted previously in this manual. Do not exceed the maximum fill pressure as this will reduce the velocity of the rifle and may damage rifle components. When using the divers bottle, refill the rifle slowly to prevent the heat created by the filling operation damaging the rifles components.

*Undo the bleeder valve on the hose before disconnecting the fill nozzle from the rifle.

You can assemble spare air cylinder to your rifle. In order to do that, first remove the air cylinder mounted on the rifle by turning it counter-clockwise. Then assemble the spare air cylinder by aligning and rotating it clockwise.

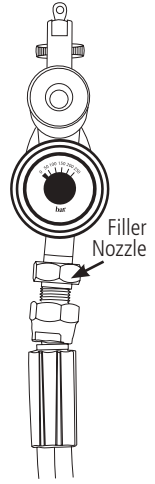

Loading the rifle & shooting

1. The magazine comes in the box as not assembled on the air rifle for safety purposes. It incorporates a raised boss on its rear face and can only be fitted one way to the rifle. It rotates clockwise when viewed from the rear of the rifle. The groove on the side of the barrel housing allows you to observe whether the next magazine chamber about to rotate into alignment with the barrel is loaded with a pellet or empty.

2. To fit the magazine on the air rifle; lift the cocking bolt, pull it backwards and lock it in the rear. (Fig. 6, Fig. 7).

THIS OPERATION COCKS THE TRIGGER MECHANISM/HAMMER ASSEMBLY. IF THE SAFETY IS SET TO OFF POSITION AND THE TRIGGER IS PULLED, THE RIFLE WILL DISCHARGE.

Push forward the magazine release bolt and lock it upwards. Remove the magazine by pulling it to the right. (Fig. 8)

3. Load pellets through the rear of the magazine. (Fig.9). Push the pellet noses through the retaining O-ring until their skirts lie flush or below the bottom of the magazine face.

4. Place the loaded magazine in its place and unlock magazine release bolt by pulling it downwards so it locks back to its place under spring load. (Fig.10). If necessary rotate the magazine counter-clockwise until its movement is arrested by the magazine stop.

DO NOT CLOSE THE COCKING BOLT / MAGAZINE RELEASE BOLT UNTIL YOU ARE READY TO FIRE. ENSURE THE COCKING BOLT IS FULLY CLOSED BEFORE FIRING THE RIFLE AS ITS PERFORMANCE WILL BE AFFECTED IF NOT FULLY CLOSE.

REAR BOLT VERSION

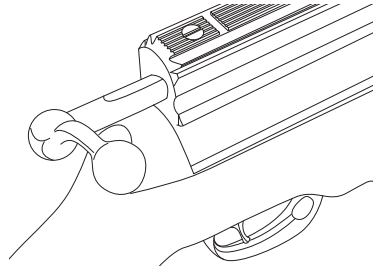
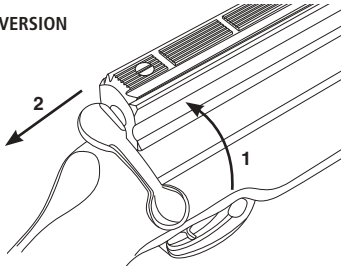

SIDE BOLT VERSION

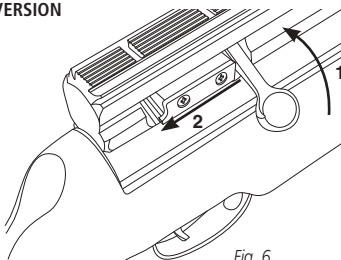

Fig. 6

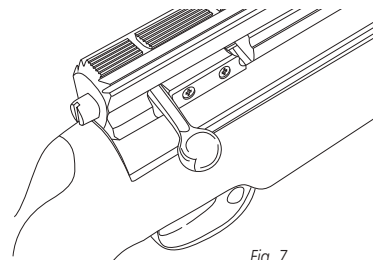

Fig. 7

5. Close cocking bolt and lock it in the forward position.
6. Sight-in either with sights or other optic sights; disengage safety and get ready for shooting.
7. Pull the trigger gently and the rifle will fire.
8. To reload rifle, pull the cocking bolt fully and close so the next pellet is indexed with the barrel. Then repeat above items 6 & 7.

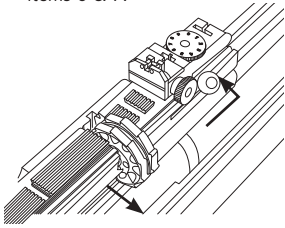

Fig. 8

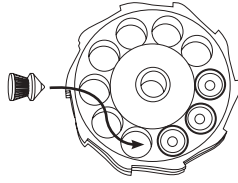

Fig. 9

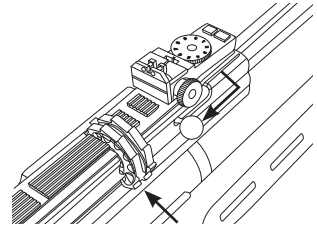

Fig. 10

Note: As the pellets are used and the magazine rotates, its empty chambers become visible above the barrel housing. These chambers may be refilled as they are revealed without removing the magazine if desired.

Note: You cannot cock the rifle and index the next pellet in the magazine unless you shoot the previous pellet in the barrel. This is because of a feature which prevents more than one pellet being loaded in the barrel which may cause damage to the rifle.

Comb Adjustment:

The comb is adjustable for elevation. Simply loosen the 2 screws located beneath the comb and adjust the comb elevation suitable to your aiming position. Then tighten the screws so the comb becomes solid. The screws can be adjusted with a suitable screw driver or with a coin.

Stock Length of Pull Adjustment

The butt pad is adjustable for stock length of pull. Simply loosen the 2 screws located on the left side of stock comb and adjust the comb elevation suitable to your aiming position. Then tighten the screws so the comb becomes solid. The screws can be adjusted with a suitable screw driver or with a coin.

Butt Pad Adjustment:

The butt pad is adjustable for height and it rotates slightly over stock providing you the perfect height and angle of the butt pad. In order to adjust the butt pad, simply loosen the bolt in the butt pad with a suitable allen wrench and heighten or lower it according to shooting conformance. Then tighten the bolt.

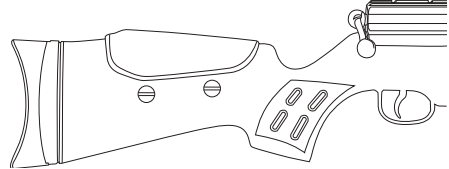
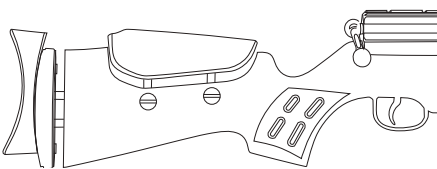

Section VII. MAINTENANCE

Warning!

Never attempt to disassemble this rifle when it is charged, except for removal and replacement of the air cylinder. Never fire the rifle when the air cylinder is removed or empty. Failure to obey this instruction could result in serious injury/death and damage to your air rifle.

Never lubricate inside the barrel as this will affect the accuracy & grouping of the rifle in negative manner.

Occasionally apply proper mineral based oils sparingly to the following parts:

- The trigger mechanism • The pellet probe • The cocking lever sliding surface
- The stern of the magazine pin and the magazine release. • The magazine axis hole and the outer O-ring.

DO NOT OVER-LUBRICATE THE RIFLE!

- It is recommended to clean the barrel with a cleaning rod every 500 shots. Never lubricate inside the barrel.

- Before you begin oiling or cleaning your air gun, always check to make sure it is unloaded.
- Always be sure your gun barrel is clean and not blocked.
- After cleaning ensure that no cleaning patch or other obstruction remains in the barrel.
- Annually, take your air gun to a gunsmith even if it seems to be working well, since some issues in your gun may not be apparent from external examination.
- Take your air gun to a gunsmith if water, sand, etc. enters the internal mechanism of the air gun, for complete cleaning. • Dangerous conditions may occur if you do not keep your air gun clean and working properly.

Quick Fill Nozzle O-Rings Replacement

After a period of time, the O-rings on the fill nozzle will need to be replaced. The need for this will become noticeable if air is heard leaking from the nozzle or the nozzle ejected from the rifle while charging the rifle. Always ensure to replace both O-rings.

Magazine O-rings Replacement

The O-ring which retains the pellets in the magazine will need to be replaced after many hundreds of shots have been fired. Its replacement becomes apparent when the rifle's cocking lever becomes stiff to operate. Repositioning the O-ring in its groove may also overcome the stiffness. Lightly oil the replacement O-ring before fitting.

Safety Measures & Warnings

- This air gun will fire if cocked, loaded, safety disengaged and trigger pulled.
- Air guns are not toys. Never let young children use an air gun unsupervised. Adult supervision is strictly required during use. Misuse or careless use may cause serious injury or death.
- Learn how your air gun operates and safe gun handling procedures before loading and using it.
- **ALWAYS USE EYE & HEARING PROTECTION AND MAKE BYSTANDERS USE THE SAME.** Failure to do so may result in eye injuries and permanent hearing loss.
- Do not point at anything you do not intend to shoot even though the gun is unloaded. Always keep the gun pointed in a safe direction. • Never pull a gun toward you by the muzzle.
- Always aim at a safe target, taking care that it does not conceal any other object.
- Before you fire, consider where the pellet will travel should you miss your intended target, thus ensuring no damage or harm could result.
- Be sure of your target before you pull the trigger. Never shoot at sounds.
- When shooting, always have a safe shooting range, that is; have a safe area for shooting, a safe distance between you and the target, and a safe backstop to trap the pellets and hold the target.
- Do not fire at a target, which allows ricochets or deflections. Do not fire into or at water.
- Do not fire at or near power lines or insulators. Be especially careful in wooded areas where power lines may not be as visible.
- Do not load the gun until you are ready to shoot.
- Always keep your fingers away from the trigger & muzzle during cocking and handling.
- Do not walk, run or jump when carrying a loaded or cocked air gun. A loaded or a cocked gun should never be carried inside a vehicle, house, camp or public place. Never climb a tree or fence or jump a ditch with a loaded gun. In such a case, first unload it and hand the gun to a friend or place it on the ground on the other side of the obstacle before crossing yourself.
- When transporting the gun, keep it unloaded and 'on safe'.
- Always keep the gun 'on safe' until you are ready to shoot even if the gun is unloaded.
- Do not put the gun away loaded and unattended.
- Always check to see if the gun is 'on safe' and unloaded when getting it from another person or from storage.
- Always keep the air gun and/or pellets out of the reach of children. Keep the air gun and pellets in separate places, better if under lock and key.
- Do not attempt to disassemble or tamper with your gun. Use a competent gunsmith. Many air guns contain powerful springs or high pressure air cylinders which can cause serious injury if released in an uncontrolled manner.
- Always handle and treat your gun as though it were loaded.
- Improper use or handling of air guns is not the responsibility of the manufacturer or distributor, under any circumstances. The user is responsible for any harm, which may be caused.
- Think first, fire second. Don't rely on any mechanical safety. Half safe is not safe.
- Air guns should never be used under the influences of alcohol or drugs.



HATSAN

ARMS COMPANY



facebook.com/hatsan.com.tr



twitter.com/hatsan_arms



youtube.com/hatsanarms

Kemalpasa O.S.B. Mah. Ansizca Sanayi Sitesi
No: 303 Iç Kapi No: 1, 35170 Kemalpasa - İzmir - TURKEY
Tel: +90 (232) 878 91 00 • Fax: +90 (232) 878 91 02

www.hatsan.com.tr info@hatsan.com.tr