

# USER GUIDE

# WARFET

LAST UPDATE ON DECEMBER 22, 2016

[WWW.GATEE.EU](http://WWW.GATEE.EU)



**GATE Menet, Wojtak Sp. J. does not take any responsibility for damages, injuries and accidents resulting in the use of this product or the use of Air Electric Gun with the product installed.**

## NOTICE

Information contained in this document is subject to updating without notice.

You should program your **WARFET** before the first use.

**FOR YOUR OWN SAFETY, PLEASE READ THIS USER MANUAL  
CAREFULLY BEFORE INSTALLING THE DEVICE**

## SAFETY SUMMARY

**THE DEVICE COVER MUST NOT BE REMOVED BY THE USER**

## DANGER!

Caution must be exercised to prevent short circuiting the battery as the consequences can be very dangerous.

## FOR YOUR SAFETY

We recommend that this product should be installed by an experienced airsoft service.

**WARNING:** Before starting installation process, please ensure that your AEG is empty and there are no BBs inside.

**WARNING:** Always use a fuse between the battery and the Power Module.

**WARNING:** Incorrectly connecting positive and negative battery terminals will cause immediate damage to the unit and it can lead to fire.

**NOTE:**

Please check if you have downloaded the latest manual from the Technical Support section of our website: [www.gatee.eu](http://www.gatee.eu). The Product Warranty Form is also available there.

In case you have any difficulties while installing or using this product, we recommend to email us at [support@gatee.eu](mailto:support@gatee.eu).

**PRODUCT DISPOSAL INSTRUCTIONS**



The symbol shown here means that the product is classed as Electrical or Electronic Equipment and should not be disposed with other household and commercial waste at the end of its working life. The Waste of Electrical and Electronic Equipment (WEEE Directive 2012/19/UE) has been put in place to recycle products using best available recovery and recycling techniques to minimize the impact on the environment. Purchasers shall take any old electrical equipment to waste recycling public centers or points of sale.



**CERTIFICATE OF CONFORMITY**

GATE Menet, Wojtak Sp. J. hereby declares under our sole responsibility that the product GATE WARFET is in conformity with the essential requirements of the following Directives: EC DIRECTIVE 2011/65/EU



This product has been certified as RoHS Compliant.

## TABLE OF CONTENTS:

Safety Summary .....	2
Table of Contents .....	4
01. Overview .....	5
• <b>WARFET</b> Features .....	5
• <b>WARFET</b> Power Module parameters .....	6
• Tactical Programming Card description .....	6
• Tactical Programming Card parameters .....	7
• Key functions .....	8
• Package contents .....	13
02. Plug & Play Installation .....	14
03. Hardwired Installation .....	16
• Switch mode .....	16
• AEG standard installation .....	16
• Installation of <b>WARFET</b> Power Module without replacement of wires .....	16
• Installation of <b>WARFET</b> Power Module with replacement of wires .....	17
04. Set up your WARFET Power Module with Tactical Programming Card .....	18
05. Pre-cocking Boost adjustment .....	20
06. Troubleshooting .....	22
07. GATE Limited Warranty Policy .....	24

## 01. OVERVIEW

**WARFET** is GATE's most advanced AEG Control System. It has 20 functions and almost 6 million possible configurations. The outstanding Tactical Programming Card provides you with very easy access to the **WARFET** Power Module settings.

Thanks to the Pre-cocking and Smart Trigger functions, you can achieve a trigger response similar to a real gun. The Programmable Burst (1-5 rounds) enables you to fire a pre-determined number of BBs, which is very useful in MILSLIM and for using low-caps. Another function is ROF Control, which allows you to reduce ROF, so you can use strong LiPo batteries, and still have ROF just like in a real rifle. If your AEG becomes jammed, the Smart Fuse protects the battery and the motor against damage. It also prevents deep battery drain. Moreover, with **WARFET** you get: MOSFET, ON/OFF Active Brake, Built-in self-test, Debouncing, and more. Many useful functions, great electrical specifications and conformal coating (military specifications: MIL-V-173C) make the AEG Control System able to meet the needs of most experienced airsoft players.

SUPER-EASY INSTALLATION - JUST PLUG&PLAY, NO SOLDERING REQUIRED

**WARFET** FEATURES

- User-friendly configuration via the Tactical Programming Card
- Sturdy and super-small size **WARFET** Power Module
- Compatibility with the strongest AEG replicas and batteries (ready to work with LiPo 14.8V, 5000 mAh, 60C)
- Tested with car batteries
- Super-easy installation - thanks to the Mini Tamiya adapters, you can connect **WARFET** to the original (stock) wiring
- It can work with most built-in MOSFETs
- With stock wiring, **WARFET** reduces melting switch assemblies

- In hardwired installation, **WARFET** draws the energy from the battery directly to the motor, bypassing the mechanical trigger contacts
- Resistant to atmospheric conditions (military specifications: MIL-V-173C)
- Deep-drain protection for 7.4V, 11.1V, 14.8V LiPoly and 9.6V, 12.8V LiFePO4
- Improves battery life, ROF, spring life and gearbox reliability

#### WARFET POWER MODULE PARAMETERS

Wide range of supply voltage: **3-17V**

Protection against short-circuits: **up to 1000A**

Incredibly low current consumption on stand-by: **0.2mA**

Ultra-low resistance: **2m $\Omega$**

Dimensions: **56x20x9mm**

Weight: **9.4g**

#### TACTICAL PROGRAMMING CARD DESCRIPTION

The outstanding Tactical Programming Card provides you with very easy access to the **WARFET** Power Module settings. All you need to do is to connect the Tactical Programming Card between the battery and the Power Module. A big advantage is that there is no need to use any additional wires. The **WARFET** Power Module can be fitted out of view in your AEG, and you still have easy access to its settings. The Tactical Programming Card communicates with the **WARFET** Power Module and displays the most recently saved settings. You can simply change them using three buttons.

TACTICAL PROGRAMMING CARD PARAMETERS

Supply voltage: **5-17V**  
 Dimensions: **67x53x7mm**  
 Weight: **27.3g**  
 Number of LEDs: **29**  
 Number of buttons: **3**



## KEY FUNCTIONS

**TACTICAL  
PROGRAMMING  
CARD****Tactical Programming Card**

The outstanding Tactical Programming Card provides you with very easy access to the Power Module settings. All you need to do is connect the Tactical Programming Card between the battery and the Power Module.

**PRECOCKING****Pre-Cocking**

Victory in the game is often a matter of fractions of seconds. Thanks to the PRE-COCKING, you gain a trigger reaction similar to a real gun. It allows for initial spring compression, which speeds up the trigger response significantly. You can set the time of PRE-COCKING using the Tactical Programming Card. There are two PRE-COCKING MODES:

- 1) AUTO MODE – the spring is automatically compressed after each shot,
- 2) TRIGGER MODE – the first trigger action compresses the spring, and the second trigger action fires the shot.

*Please note: using PRE-COCKING increases wear and tear on the gearbox. PRE-COCKING is designed for SEMI mode. In the AUTO mode, it can result in blank shots.*

**Plug&Play****PLUG&PLAY**

Super-easy installation, just plug and play. No soldering required. All you need to do is connect the battery and the rifle to the Power Module.

**1-5rd Burst****Programmable Burst**

The burst enables you to shoot a pre-determined number of BBs (1-5 rounds), which is very useful in MILSLIM and when using low-caps. You can transform AUTO MODE to BURST MODE or SEMI MODE to BURST MODE\*. The Tactical Programming Card allows you to set the burst time. The Power Module automatically corrects the burst time according to the voltage level of the battery.

*\*SEMI to BURST in modified installations only.*



## 3rd Burst



### 3-rd burst

Burst mode enables you to make 3-shot series. In this way you can save ammunition and increase the realism. You can change AUTO mode to BURST mode or SEMI\* mode to BURST mode.

If in SAFE/SEMI/BURST mode you release the trigger earlier, you can make one or two shots. The burst time is set in the menu with accuracy to 4ms. The processor actively compensates for the change in burst time with a decrease in the rate of fire due to battery discharging.

*\*SEMI to BURST in enhanced mode only*



## CONFIGURABLE FIRE SELECTOR

### Configurable Fire Selector

The function gives you the option to program your fire selector. There are five modes:

- STOCK WIRING SEMI/AUTO
- STOCK WIRING SEMI/BURST
- MODIFIED WIRING SEMI/AUTO
- MODIFIED WIRING SEMI/BURST
- MODIFIED WIRING BURST/AUTO



## ROF CONTROL

### Rate Of Fire Control

This ensures there is no loss of the rifle's rate of fire, so you can use stronger LiPo batteries, and still have ROF just like in a real gun.



## SMART TRIGGER

### Smart Trigger

We know how vital the fast trigger response is during combat. This is why we have developed the Smart Trigger function. It enables you to achieve a faster trigger response. It works with the ROF Control system. During the first shot, the microprocessor sets the ROF Control to 100%. After the first shot, it switches to a previously programmed value (e.g. 50%). As a consequence, the first shot is fired at a full rate of fire, and subsequent shots at a reduced ROF. The best results can be achieved by using a battery with a higher than standard voltage. For example, if you use a 7.4V battery, you can replace it with 11.1V. In this way, you will achieve a faster trigger response with the same rate of fire as with a standard battery. The Smart Trigger is most effective when the Burst time is set at 3 rounds.



## BATTERY PROTECTION

### Battery Protection

Protection against Over-Discharge of the Battery. Modern LiPo and LiFe batteries are very sensitive to over-discharge. If you do not want to damage the battery and you care about its service life, this protection is indispensable. The microprocessor monitors the battery voltage constantly. When the voltage drops down to a critical level, the Power Module will not allow firing.



## SMART FUSE

### Smart Fuse

We have developed an electronic fuse with an accurate current sensor. A combination of current, voltage and temperature measurements makes your AEG installation highly reliable. It protects the MOSFET against overheating, overloading and short-circuiting. If your airsoft gun becomes jammed, the function protects the motor and battery against damage.



## ELECTRONIC FUSE

### Electronic Fuse

We know how important reliability is on the battlefield. That's why the unit has thermal protection. In tandem with a time-lag fuse, it fully protects your AEG installation.



## ON/OFF ACTIVE BRAKE

### ON/OFF Active Brake

The Power Module provides you with the opportunity to decide if you want to use the Active Brake function. If you do not need this, you can turn it off easily. It will lead to improving the lifespan of your motor.



## ACTIVE BRAKE

### Active Brake

Do you care about realism? Would you like to increase the life of the gearbox? Does your rifle have such a high rate of fire that you are not able to make a single shot? The Active Brake sorts things out. In SEMI Mode, the brake does not allow for compressing a piston after a shot. The piston will stop in the front position which eliminates unnecessary stresses, increasing the service life of the gearbox and its parts. This is important, especially with an AEG power upgrade. After releasing the trigger, the rifle immediately stops firing. So, you gain more realism and, additionally, you do not waste your precious ammunition.



## MOSFET

### MOSFET

Do you want to achieve a higher rate of fire and faster trigger response? Are you planning a power upgrade of your rifle? In that case, you need a MOSFET.

It targets the energy from the battery directly to the motor, bypassing the mechanical trigger contacts. As a result, you gain a higher rate of fire of the rifle and a faster trigger response, and the contacts are protected against burn out.



## DEBOUNCING

### Debouncing

This provides full compatibility with the micro-switches. It ensures full resistance to contact bounce (vibration). You gain a bigger ROF, a faster trigger response and your MOSFET is less prone to overheating.



## BUILT-IN SELF-TEST

### Built-In Self-Test

It allows you to quickly check whether the Power Module works properly. If you have problems with your AEG, the BUILT-IN SELF-TEST allows you to check that the problem is not caused by the Power Module.



## 3<sup>rd</sup> GEN MOSFET

### 3<sup>rd</sup> Generation MOSFET

The advent of modern transistors and microcontroller has enabled us to create the smallest and most reliable Power Module on the market.



## DARK MODE

### Dark Mode

DARK MODE allows you to turn off the green LED which lights up when a gun is firing. This function is especially useful during night games.



## COATING

### Coating

Thanks to its special conformal coating, it is resistant to atmospheric conditions (Military Specification MIL-V-173C).

14.8V



## Li-Po Ready

### 14.8V LI-PO Ready

The system can be used with batteries up to 14.8V LI-PO. Minimum operating voltage is 3V and maximum voltage is 17V.

**HARDWIRED****Hardwired**

In the case of a hardwired installation, the Power Module draws the power from the battery directly to the motor, bypassing the mechanical trigger contacts. This requires a modification of the AEG installation.

**MINI TAMIYA READY****MINI TAMIYA Ready**

Thanks to the Mini Tamiya Adapters included in kit, you will be able to smoothly connect AEG Control System to your original installation.

**PRINTED  
QUICKSTART****Printed Quickstart**

It makes easier starting your adventure with a new product. The quickstart contains basic information and hints.

INCLUDED IN THE KIT:

- 01 Tactical Programming Card
- 02 **WARFET** Power Module
- 03 Battery Mini Tamiya adapter
- 04 AEG Mini Tamiya adapter
- 05 Pair of Deans-T Connectors
- 06 Single Trigger Wire
- 07 Double Trigger Wire
- 08 Quickstart Guide



ALSO AVAILABLE **WARFET** POWER MODULE KIT WHICH INCLUDES:

- **WARFET** Power Module
- Battery Mini Tamiya adapter
- AEG Mini Tamiya adapter
- Pair of Deans-T Connectors
- Single Trigger Wire
- Double Trigger Wire

## PLEASE NOTE

**There is no Programming Card included in this kit.**

The Programming Card is necessary for proper configuration. The **WARFET** Power Module is dedicated for users who, for example, have a few guns, and want to use several **WARFET**s. Therefore, they do need only one Tactical Programming Card for configuration of all their **WARFET**s.

If you have already bought a standard version of **WARFET** with Tactical Programming Card, and you want to buy one **WARFET** more, purchasing **WARFET** Power Module is more profitable.

## 02. PLUG&PLAY INSTALLATION

**Step 1.** If necessary, connect Mini Tamiya adapters (included in the kit) to **WARFET** Power Module.

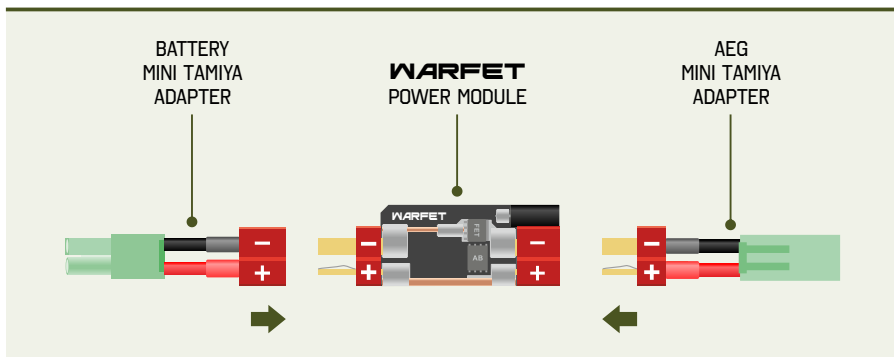

**Step 2.** Connect the battery to **WARFET** Power Module. The LED indicator glows BLUE for one second.

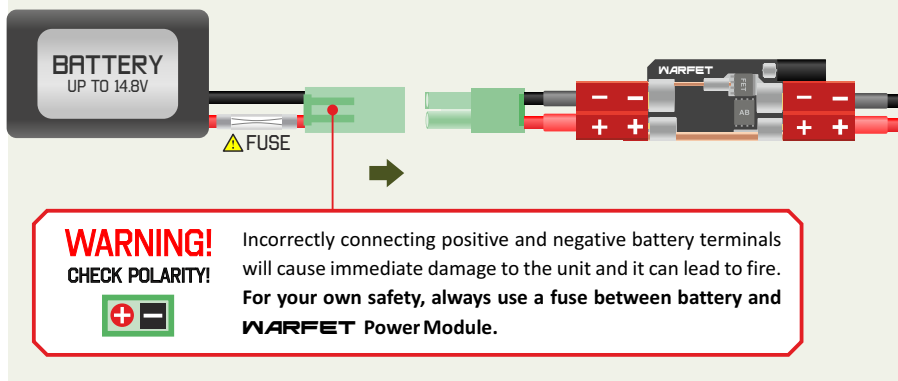

**Step 3.** Connect the AEG to **WARFET** Power Module.

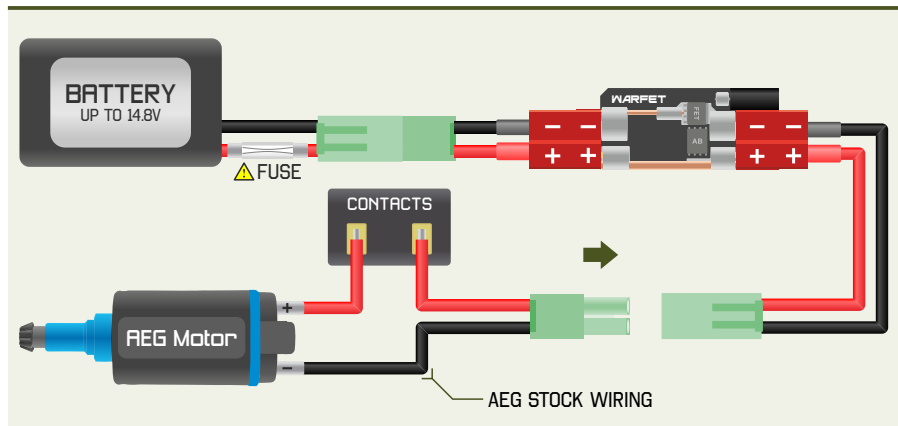

**Step 4.** Pull the trigger.

The AEG should start firing. While firing, the LED indicator should glow GREEN\*. If the AEG is not firing and/or LED indicator glows different colour, please check troubleshooting (page 20).

*\*only when DARK MODE OFF*

**Step 5.** To change settings go to chapter 04 (Programming Card usage).

## 03. HARDWIRED INSTALLATION

### Step 1. Switch mode.

To be able to work with Hardwired Installation, necessarily go to chapter 04. (Programming Card usage, p. 18) and switch mode to MODIFIED WIRING.



### Step 2. Adapt AEG installation.

To adapt the standard AEG installation to work with **WARFET** Power Module you have to get to the trigger contacts. In case of GB v2 contacts are located inside a gearbox. With a version 3 gearbox, installation is easier because the contacts are on the outside of the gearbox. Please consult a local airsoft technician if you have never disassembled a gearbox before or if you have any installation concerns.

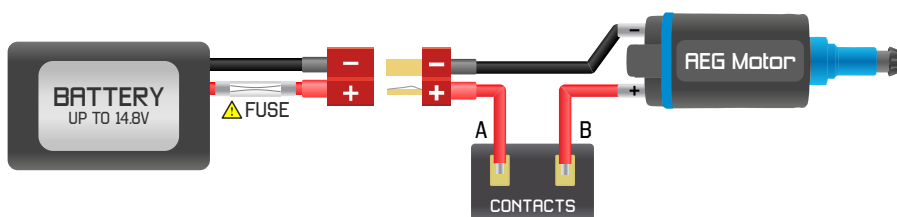

FIG 1. – STANDARD AEG WIRING SCHEME

#### a) Installation of **WARFET** Power Module without replacement of wires

Using this method, the original wiring is kept intact, and the connections are modified. Referencing Fig 1., de-solder A wire from the one of the trigger contacts and then solder it to the B wire. It does not matter which wire you disconnect from the trigger switches, just join the two wires together at one terminal. In the place of the A wire, solder the additional single trigger wire (No. 6 – provided in the kit).



The trigger wire is very thin because it handles very low current and it is only used for switch-detection. Now connect the device between the battery and AEG. Do not forget about the trigger wire. Connect it to the top pin.

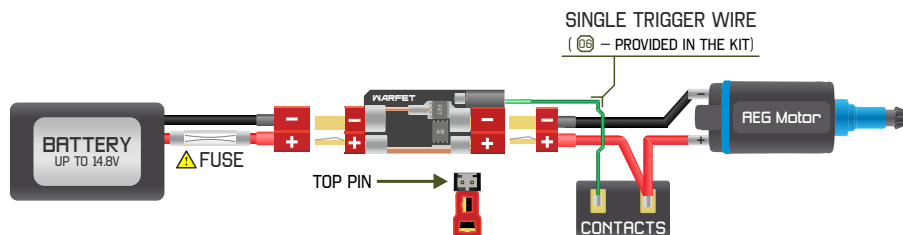

FIG 2. CONNECTION-MODIFICATION SCHEME

**b) Installation of WARFET Power Module with replacement of wires**

Replacing the existing AEG wiring with high-quality, low-resistance wiring in conjunction with the installation of a MOSFET allows for the ultimate in system efficiency. 16 awg or thicker wire is recommended. Solder the double trigger wire (No. 7 – provided in the kit) to the trigger contacts. The trigger wire is very thin because it handles very low current and it is only used for switch-detection. Now connect the device between the battery and motor. Do not forget about the trigger wire.

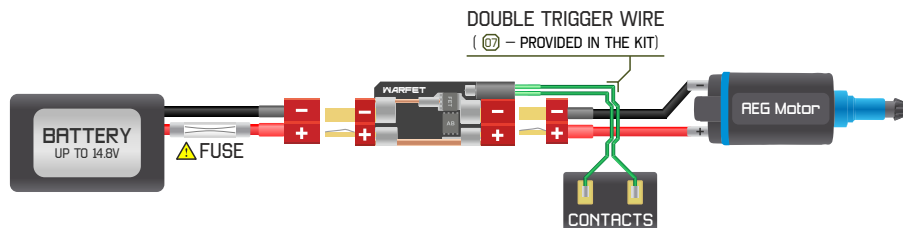
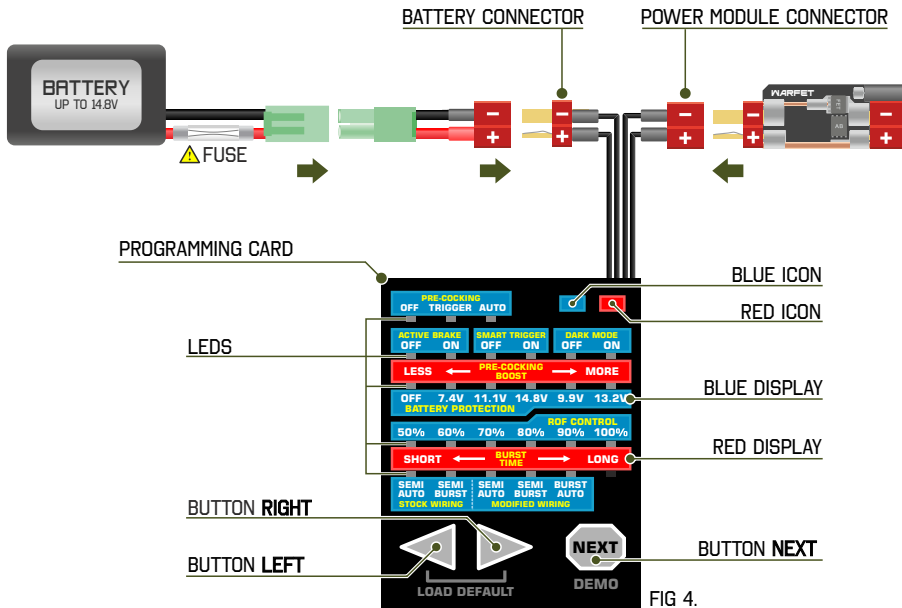

FIG 3. COMPLETE RE-WIRING SCHEME

**Is your AEG firing without pulling the trigger?**  
 Go to chapter 04. and switch mode to **MODIFIED WIRING**

## 04. SET UP YOUR WARFET POWER MODULE WITH TACTICAL PROGRAMMING CARD



### Instructions:

1. Connect the battery to the **Programming Card**. The LEDs light on and start blinking (Fig 4.).
2. Connect the **WARFET Power Module** to the **Programming Card**. All current settings are displayed on the corresponding LEDs (Fig 5.).
3. When the **BLUE ICON** is on, check only on the blue display of the **Programming Card** (Fig 5.).

When the **RED ICON** is on, check only on the red display of the **Programming Card** (Fig 6.).

4. Click and hold button **NEXT** to watch **DEMO**.
5. Click button **NEXT** to switch between functions and displays.
6. Click buttons **LEFT** or **RIGHT** to switch options.
7. Click and hold buttons **LEFT** or **RIGHT** to switch options more quickly.
8. Before firing, disconnect the **Programming Card** and connect the **WARFET Power Module** to the battery.
9. All the settings are saved automatically.
10. Click and hold buttons **LEFT** and **RIGHT** to load default settings.

**How to read settings? Take a look at the examples below:**

**EXAMPLE 1.** The **BLUE ICON** glows. Check only on the blue display.

PRE-COCKING	OFF
ACTIVE BRAKE	OFF
SMART TRIGGER	OFF
DARK MODE	OFF
BATTERY PROTECTION	7.4
ROF CONTROL	100%
STOCK WIRING	SEMI/AUTO

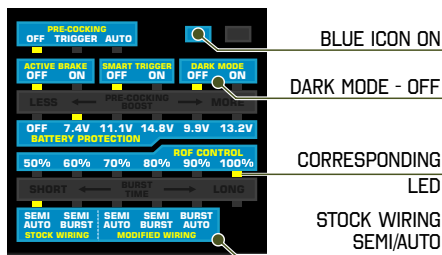

FIG 5.

**EXAMPLE 2.** The **RED ICON** glows. Check only on the red display.

PRE-COCKING BOOST	maximum value
BURST TIME	minimum value

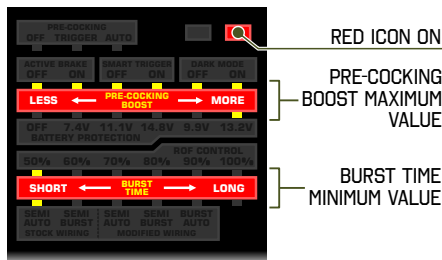

FIG 6.

## 05. PRE-COCKING BOOST ADJUSTMENT

## PLEASE NOTE!

*Making changes in Active Brake, Smart Trigger, ROF Control or BURST TIME settings might result in necessity of re-adjustment of Pre-cocking Boost. Therefore, Pre-cocking Boost settings should be exercised as the last step of WARFET configuration.*

**Instructions:**

1. Switch Pre-cocking to Trigger mode according to "04. Tactical Programming Card usage" (p.18).



2. Connect WARFET to your AEG according to "02. Plug & Play Installation" (p.14) or "03. Hardwired Installation" (p.16). Switch your AEG fire selector to SEMI mode. Pull the trigger **two times**. The first trigger action fires a shot, and the second trigger action should compress the spring.

a) if the second trigger action fires a shot instead compressing the spring, it means that Pre-cocking Boost value is too large. Go to Pre-cocking Boost settings and reduce boost value.

LED IS BLINKING



CLICK BUTTON LEFT TO REDUCE BOOST



**NOTE:** Pre-cocking Boost has 36 positions. Click and hold buttons **LEFT** or **RIGHT** to switch between them more quickly.

b) if the second trigger action compresses the spring, you can try to increase Pre-cocking Boost value to raise efficiency of Pre-cocking. Go to Pre-cocking Boost settings and increase Pre-cocking Boost value.

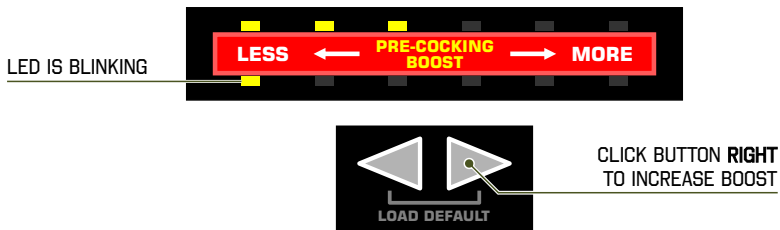

## 06. TROUBLESHOOTING

MALFUNCTION	POSSIBLE REASON	WHAT TO DO
After connecting the battery to the Power Module, the LED indicator does not light on. <b>WARFET</b> does not react.	The battery is discharged. No contact with the battery.	Charge the battery. Clean the battery connector. Clean the Power Module connector.
After a trigger action, the LED indicator glows red. Even though the motor is connected, the AEG does not fire.	The battery is discharged. The BATTERY PROTECTION function is badly programmed. No contact with the battery. A short-circuit between the signal wires and the motor wires (in Hardwired Installation only). A short-circuit of the motor wires. A short-circuit of the motor.	Charge the battery. Program the BATTERY PROTECTION function correctly. Clean the battery connector. Clean the <b>WARFET</b> connector. Check and repair the signal wires insulation and the motor wires insulation. Connect another motor.
After a trigger action, the LED indicator blinks red. Even though the motor is connected, the AEG does not fire.	A permanent damage to the Power Module.	Contact GATE Technical Support: <a href="mailto:support@gatee.eu">support@gatee.eu</a>

## ⚙️ PLUG&PLAY INSTALLATION ⚙️

The <b>WARFET</b> does not react to any trigger action. The AEG does not fire.	The battery is discharged. No contact in the switch assembly. No contact with the motor connectors. The motor wires are broken. The motor windings are broken.	Charge the battery. Clean the switch assembly. Clean the motor connector in the Power Module. Check the motor connectors. Repair the wires. Repair the motor or replace it with a new one.
After a trigger action, the LED indicator blinks green shortly. Even though the motor is connected, the AEG does not fire.	A weak contact with the contact cube. A weak contact with the motor connectors. The motor wires are damaged. The motor windings are damaged.	Clean the contact cube or replace it with a new one. Clean the motor connector in the Power Module. Check the motor connectors. Check and repair the motor wires. Repair the motor or replace it with a new one.

MALFUNCTION	POSSIBLE REASON	WHAT TO DO
After a trigger action, the LED indicator glows yellow. Even though the motor is connected, the AEG does not fire.	The <b>WARFET</b> is set on the Modified Wiring mode.	Reprogram the <b>WARFET</b> for the Stock Wiring mode.
After connecting the motor to the Power Module, the AEG starts firing immediately.	A short-circuit in the switch assembly.	Check and repair the switch assembly.

**⤴ HARDWIRED INSTALLATION ⤵**

The <b>WARFET</b> does not react to any trigger action. The AEG does not fire.	<p>The <b>WARFET</b> is set on the Stock Wiring mode.</p> <p>No contact with the Signal Socket.</p> <p>No contact with the switch assembly.</p> <p>A short-circuit or break in the trigger wire (from the switch assembly).</p>	<p>Reprogram the <b>WARFET</b> to the Modified Wiring mode.</p> <p>Clean the Power Module Signal Socket.</p> <p>Clean the switch assembly or replace it with a new one.</p> <p>Repair the trigger wire or replace it with a new one.</p>
After a trigger action, the LED indicator glows yellow. Even though the motor is connected, the AEG does not fire.	<p>No contact with the motor.</p> <p>The motor wires are broken.</p> <p>The motor windings are broken.</p>	<p>Clean the Power Module connector.</p> <p>Check and repair the motor wires.</p> <p>Repair the motor or replace it with a new one.</p>
After connecting the motor to the Power Module, the AEG starts firing immediately.	The <b>WARFET</b> is set on the Stock Wiring mode.	Reprogram the <b>WARFET</b> to the Modified Wiring mode.

**07. GATE LIMITED WARRANTY POLICY**

GATE Menet, Wojtak Sp. J. warrants that this Product is free from manufacturing and material defects at the date of purchase and for a period of one (1) year from the date of purchase and it is not-extendable. This Limited Warranty concerns both the Power Module and the Tactical Programming Card and is conditioned upon proper use of them by Purchaser.

1. This Limited Warranty is valid provided that the owner provides a proof of purchase and properly completed warranty form. The warranty form is available on our website: <http://www.gatee.eu/>.

2. This Limited Warranty does not cover: (a) defects or damage (eg. mechanical, thermal or chemical) resulting from accident, misuse (misinterpretation of the instructions), abuse, neglect, unusual physical, electrical or electromechanical stress, water immersion, repairs or structural modification of any part of Product (eg. heat-shrink tube removal), or (b) the Product that has the serial number removed or made illegible; (c) defects or damage from improper operation, maintenance or installation, (d) installation of the products.

3. Requests for warranty are processed as soon as possible, not exceeding seven (7) working days. The company's obligation under this Limited Warranty shall be limited to providing replacement of part/s only.

Contact: [support@gatee.eu](mailto:support@gatee.eu)