



User Manual



www.acetek.com

❖Specification

- ※ Measures Muzzle Velocity from 30 m/s ~ 400 m/s (90 ft/s ~ 1200 ft/s).
- ※ ROF range: 100~5000RPM
- ※ Extra large caliber (diameter 36mm)
- ※ Tripod Ready mounting hole (Screw for standard camera / camcorder tripods)
- ※ Use AAA Alkline battery*4 (Do not use Carbon Zinc battery)
- ※ Support Micro-USB(5V/0.5A) power input(n battery charge function)
- ※ Weight: 290g without battery.
- ※ Size : L x W x H = 130 x 108 x 61 (mm).

*All the specifications and contents in this manual are subject to change without notice.

*All the specifications and contents are only for reference, please make the object as the standard.

❖Product information

- ◎ AC6000 is an airsoft chronograph with high quality and accuracy
- ◎ User-friendly interface with 128*128 pixel OLED in white color.
- ◎ Support Micro-USB(5V/0.5A) power input(no battery charge function) or Use AAA Alkline battery*4
- ◎ Ammo parameter setting supports 5 memory slots
- ◎ ROF : Must fire at least 10 rounds consecutively to get the first ROF data.
- ◎ AMMO 1~5 parameter can be selected on SCR1.
- ◎ 25 memory slots for velocity and ROF (Rate Of Fire)
- ◎ Auto-calculate MAX, MIN, AVG from shot memory slots
- ◎ Idling and low battery auto power off function.
- ◎ Tripod ready mounting hole (standard camera screw / camcorder tripods)
- ◎ Large caliber for 36mm, suitable for different BB Spec. 4.5mm, 6mm, 9mm, 18mm.

❖Panel Introduction

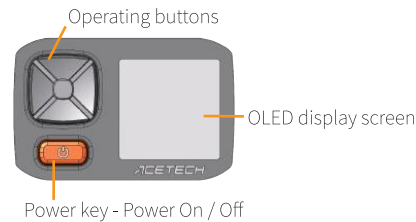

❖MENU

- ◎ MENU : Function Setting Screen



- ※ To use direction key to setup parameter value

- ◎ AMMO : Set BB information

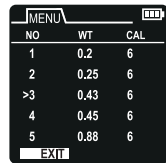

- 5 memory slots for setting BB weight (WT) & Caliber (CAL)

- ◎ UNIT : Unit Setting

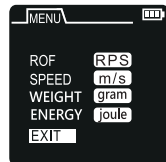

- ※ ROF : Rate Of Fire
RPM : Round Per Minute
RPS : Round Per Second
- ※ SPEED : Initial Velocity
m/s : Meter per Second
ft/s : Feet Per Second
- ※ WEIGHT :
gram(g)
grain(gr) (1 grain=0.0648gram)
- ※ ENERGY : joule
ft-lb

- ❖ SCR1 : Shows the velocity,rate of fire(ROF)and energy measurement. You could also select Ammo parameter on this page.

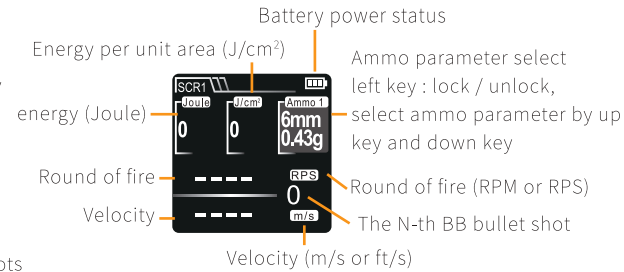

- ❖ SCR2 : Screen 2

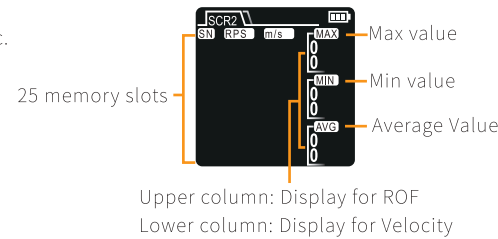

- ※ Press up/down key to read the speed data
- ※ Press and hold up key for 3 seconds to clear historical speed data.

- ◎ APO : Auto Power Off



- Auto power off after idling for 5 ~ 60minutes for power saving.

- ◎ BRIGHTNESS : OLED brightness

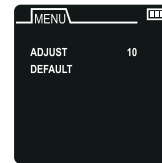

- ※ ADJUST : 0 ~ 10
- ※ DEFAULT : 6

- ◎ RESET : Factory Default



- ※ Reset AC6000 :
Recover factory default value.
- ※ CALIBRATION :
To calibrate the inner infrared sensors.

- ❖ Each part of description

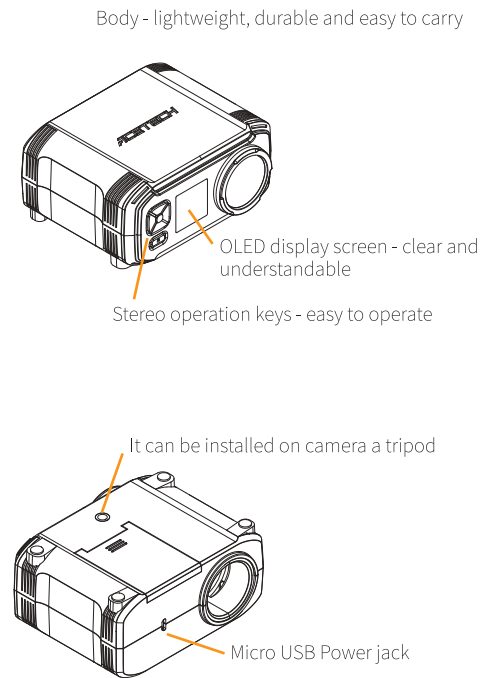

❖Battery Description

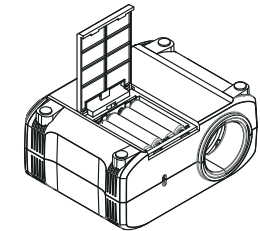

1. Push out the battery cover.
2. Put in 4 AAA Alkline batteries. (Do not use Carbon Zinc battery)
3. Close the battery cover.
4. Do Not install the used and new batteries at the same time for better device performance, safety and stability.
5. When device is not used for a longer period, please take out the batteries to prevent device malfunction from battery leakage.