



**LEAPERS<sup>®</sup>, INC.**

**OPTICS**

**USER MANUAL**

**Complete Installation and  
Operating Instructions**

[WWW.LEAPERS.COM](http://WWW.LEAPERS.COM)

# LEAPERS® INC.

Proudly Presents



## OPTICS

**RANGE  
ESTIMATING SCOPES**

**RETICLE  
INTENSIFIED SCOPES**

### TOTAL SOLUTION TO YOUR NEEDS

COMMITMENT TO BEST QUALITY, BEST VALUE AND BEST SERVICE

**www.LEAPERS.com**  
**32700 Capitol Street**  
**Livonia, MI 48150 U.S.A.**  
**Tel:(734)542-1500**  
**Fax:(734)542-7095**  
**Email:office@leapers.com**

## Index

A. Scope Parts Illustration .....	4
B. Major Features .....	7
C. Mounting the Scope .....	8
D. Understanding the Reticle .....	11
E. Adjusting Diopter .....	14
F. Installing Battery .....	14
G. Adjusting Reticle Illumination .....	14
H. Adjusting Magnification .....	15
I. Adjusting Parallax .....	16
J. Zeroing .....	16
K. Removing and Installing Lens Caps .....	22
L. Installing Sunshade .....	22
M. Care and Maintenance .....	23
N. Limited Lifetime Manufacturer's Warranty .....	23

# A. SCOPE PARTS ILLUSTRATION

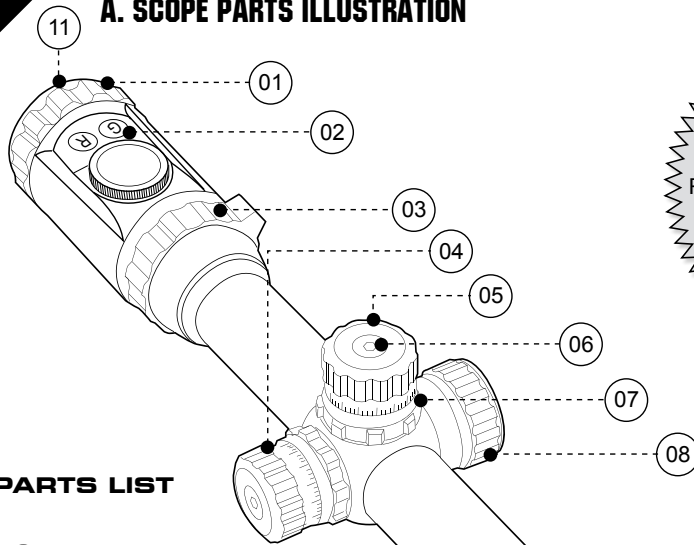

  
**WARNING:**  
Read entire manual before mounting your scope. Make sure the firearm is not loaded upon installation.

## PARTS LIST

- 01 Eyepiece Assembly
- 02 EZ-TAP Control Panel (For Reticle Illuminated Models with IE Capability)
- 03 Power Ring (For Variable Power Models Only)
- 04 Windage Adjustment Knob
- 05 Elevation Adjustment Knob
- 06 Adjustment Hex Screw (For Models with Center Hex Screw in Turrets)
- 07 Zero Locking Ring (For Models with Zero Locking Function)
- 08 Reticle Illumination Rheostat (For Reticle Intensified Models Only)  
OR  
Parallax Adjustment Side Wheel (For Side AO Models Only)
- 09 Objective Parallax Adjustment Ring (For Front AO Models Only)
- 10 Objective Lens Protective Ring (For Models with Protective Ring)
- 11 Ocular Lens
- 12 Integral Sunshade (For Models with Angled Objective Bell)

**Note:**  
Scope diagram is for illustration purposes only, not intended to represent your actual product appearance.

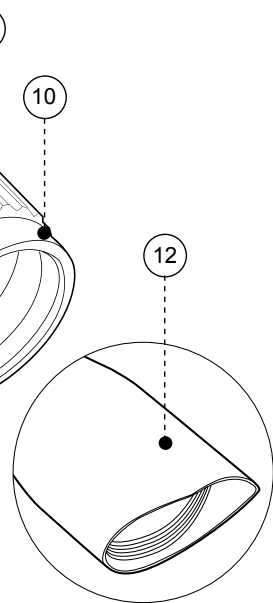

## ACCESSORIES

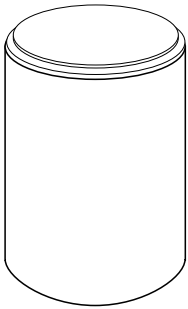

Optional - 3" Sunshade  
(for 50mm Obj. Dia. Models)

Optional - 2.5" Sunshade  
(for 40mm Obj. Dia. Models)

Optional - 2" Sunshade  
(for 32mm Obj. Dia. Models)

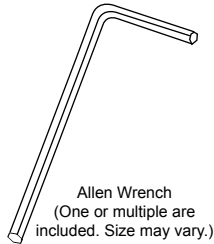

Allen Wrench  
(One or multiple are included. Size may vary.)



Battery  
(For Reticle Intensified Models Only)

Cleaning Cloth



Flip-open Lens Caps  
(Appearance may vary.)

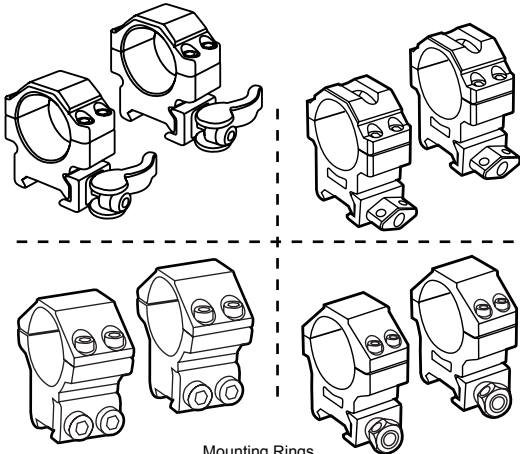

Mounting Rings

(Not all models include rings. Appearance may vary.)

## B. MAJOR FEATURES

### ► Built on True Strength Platform, Completely Sealed and Nitrogen Filled, Shockproof, Fogproof and Rainproof

- Rugged one piece tube construction for all terrains/weather.
- Smart Spherical Structure (SSS) with highly synchronized joint motion achieving the most responsive, precise and reliable windage and elevation adjustment.
- Precision machined to exact tolerances from aircraft-grade aluminum alloy to achieve the desired performance under most heavy recoil.
- Completely sealed and nitrogen filled to eliminate risk of water ingress and fogging.
- Positive and precise click value for accurate and consistent shooting.
- Most disciplined quality control and extensive shock and vibration testing to guarantee optimal recoil resistance capability and consistent performance.

### ► Multi Layer Lens Coating for Optimum Light Transmission

- Unique high tech coatings applied to lens elements ensure best light transmission for optimal optical performance.
- Multi layer coatings ensure maximum utilization of all ambient light for the best resolution and clarity.

### ► Target Turrets with Unique Zero Locking and Zero Resetting Features (For Models with Zero Locking/Resetting Functions Only)

(For Models with Zero Locking/Resetting Functions)

- Most innovative design for user friendly windage and elevation control.
- Easy and repeatable Zero Locking and Zero Resetting provides the most needed protection and convenience.

### ► Wide Field of View and Tactical Mil-Dot Reticle (For Range Estimating Models Only)

- Wide field of view and edge to edge lens clarity makes it easy to pick up quarry on the peripheral edge of the sight image.
- Precise tactical Mil-Dot reticle allows the shooter to estimate ranges for most optimal aiming and shooting performance.

### ► High Quality Precision Machined Parts

- Precision machined parts guarantees smooth and accurate operations and delivers consistent and reliable performance.

### ► Illuminated Reticle with Red/Green Dual Color or 36-color IE Illumination (For Reticle Intensified Models Only)

- Adjustable color and intensity of the illuminated reticle gives optimum reticle clarity in variable light conditions, increasing accuracy in daylight and twilight environments.

## C. MOUNTING THE SCOPE

**CAUTION:** Always ensure your rifle is UNLOADED, UNCOCKED and, where applicable, the safety catch is applied before fitting the scope. Practice safe handling procedures at all times.

Ensure you have top quality rings from UTG. Buying cheap rings is a false economy and can result in poor performance from your combo.

### C-1. QD Lever Lock

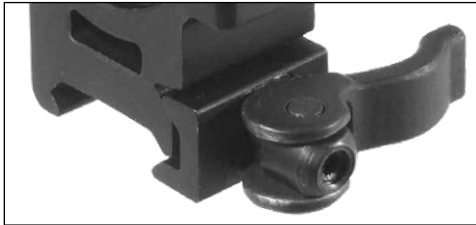

### C-2. Twist Lock



### C-3. Thumb Nut Lock



### C-4. Hex Screw Lock



## ★ Mounting C-1 Rings on Rail



1. Turn the Cam Lever leftward to its unlocked position. Place the QD ring on the Picatinny rail at a desired position. Seat the cross bolt at the bottom of the ring into a selected Picatinny slot.



2. Turn the Cam Lever from left to right to begin locking the QD ring on the rail, but do not complete the locking motion, leaving some travel distance to allow for adjustment.



3. Use the included Allen wrench to adjust the Hex Screw at the side of the cam for proper tension and fit against the rail. Adjust clockwise to increase the tension and tighten the clamping width. Adjust counter-clockwise to decrease the tension and increase the clamping width.



4. The optimal tension is achieved when the side plate first makes contact with the Picatinny rail while the Cam Lever still has enough travel left for you to securely snap into its locking position. Once you achieve the optimal tension, push the Cam Lever all the way to the right for a positive lock onto the rail. You may repeat Step 3 and 4 if needed to find the best clamping tension and locking position for your rings on the rail.

Go to ★ Mounting Scope in Rings

## ★ Mounting C-2 or C-3 Rings on Rail

### Locking Holes



1. Fit the ring bases to the mount rail of the rifle.
2. Tighten the Twist Lock or the Thumb Nut with your finger. To ensure a firm grip, plug the long end of the Allen Wrench into the Locking Holes and further tighten it by turning the short end.

Go to ★ Mounting Scope in Rings



2. Place your scope on the ring bases. Put the rifle to your shoulder in your natural shooting position and adjust the scope eye relief until you achieve a full field of view. When you have found the ideal eye relief, rotate the scope so the reticle crosshair is vertical and perpendicular to the rifle.

## ★ Mounting C-4 Rings on Rail

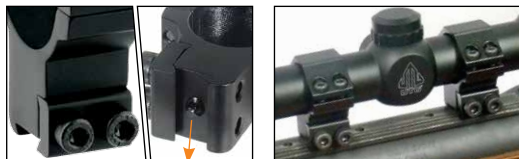

### Stop Pin

1. Fit the ring bases to the mount rail of the rifle.
2. Make sure that the Stop Pin in one of the rings fully sink into the position hole on the rail if applicable. Insert the short end of the Allen Wrench into the screw and fully tighten by turning the long end and ensure a firm grip.

Go to ★ Mounting Scope in Rings



3. Replace the top ring halves and tighten the screws evenly by the cross-torque pattern. Do not over-tighten the screws as damage to scope tube may occur. It is recommended to grasp the Allen wrench by its short end to perform final tightening of the screws with torque value at about 15 inch-lb. Using the long end of the Allen wrench to tighten ring screws will result in over-tightening and may cause permanent damage to rings and deformation of scope tube. The scope is now ready to be zeroed.

## ★ Mounting Scope in Rings

(Ring style in images is for illustration purposes only. Style may vary.)



1. Remove the top half of the ring by loosening the screws and slowly backing them out.

## D. UNDERSTANDING THE RETICLE

1. Each scope has a reticle for aiming. A reticle is a thin planar component disposed perpendicular to the optical axis inside the main tube. It is made by etched metal film or etched glass. The former is called Wire Reticle, and the latter is called Etched Glass Reticle.
2. For Leapers riflescopes, the reticle is on the second image plane. The reticle does not change when the magnification is adjusted. But, the space the reticle occupies on the target image does change when magnification changes. The smaller the magnification, the bigger space the reticle occupies on the target image.
3. Leapers offers a variety of reticles for different scopes. See the reticle table for the introduction.

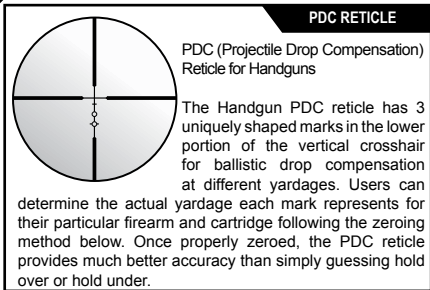

### Zeroing Handgun Scope

#### with the PDC (Projectile Drop Compensation) Reticle:

Follow the steps below to zero a handgun scope with PDC Reticle:

1. Place target at the most common distance you shoot (we recommend 35 yards if possible). Aim at the center of the target with center crosshair and sight in. (Please refer to the Zeroing section of the manual for windage/elevation adjustment.)

2. Set your scope to the highest magnification. Shoot at each 50 or 100 yard increment depending on the trajectory of your firearm and cartridge, using one mark in the lower vertical crosshair each time. Record the bullet point of impact in relation to your point of aiming.
3. Make adjustment to the shooting distance accordingly to determine the actual yardage each mark represents. We highly recommend that you document these distances.
4. Use hold-over or under in real applications for in-between yardages.

#### Eyeiece Lock Ring

Your scope is equipped with an eyeiece lock ring to prevent movement of the eyeiece focus during shooting. To adjust diopter, first turn the eyeiece counter-clockwise to loosen the lock. Then, turn the lock ring clockwise away from the eyeiece to allow room for adjustment. Follow the procedures in the **Adjusting Diopter** section of the manual to make adjustment. Once complete, turn the lock ring counter-clockwise to tighten against the eyeiece.

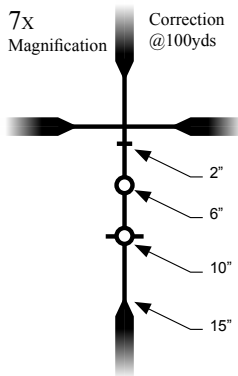

#### UNLOCK THE LOCK RING



<p><b>TARGET DOT RETICLE</b></p> <p>This Target Dot reticle consists of a small floating dot in the center surrounded by four thin posts extending to the edge. The posts stand out against the background and help guide shooter's focus to the aiming dot for rapid engagement. This reticle pattern offer the user eased target acquisition while sacrificing little in terms of precision.</p>	<p><b>CIRCLE DOT RETICLE</b></p> <p>Circle Dot reticle includes a floating circle and a dot in the center, which is ideal for shotgun shooting, fly hunting as well as tactical applications that require quick target acquisition. The circle and the dot are permanently etched on glass, not requiring illumination to be seen. The typical size is about 1.8MOA for the dot and about 36MOA for the circle.</p>
<p><b>PRO 4-STEP RETICLE</b></p> <p>Pro 4-step reticle comes with 1 vertical line, 3 horizontal lines and 4 floating points. It is designed for crossbows and other applications requiring variable velocity compensation. The first horizontal line including the first central point is used for sighting in at 20Yds. The 2 lines below including their middle points are for quick aiming at 30, 40-yard distances. The lowest floating point is for quick aiming at 50-yard distance.</p>	<p><b>PRO 5-STEP RETICLE</b></p> <p>Pro 5-step reticle is designed for crossbows and other applications requiring variable velocity compensation. The reticle consists of 5 horizontal lines which are calibrated for 300fps Crossbows and 1 vertical line with a thin crosshair in the center. The first horizontal line is used for sighting in at 10Yds and the other horizontal lines below are for quick aiming at 20, 30, 40, 50-yard distances.</p>
<p><b>BUBBLE LEVEL RETICLE</b></p> <p>Bubble level reticle includes a precision built-in bubble leveling system. The internal bubble leveler is located at the bottom of crosshair with the least field of view impediment. It is a great tool for precision scope installation/crosshair alignment to deliver the most prominent shooting accuracy.</p>	<p><b>BDC RETICLE</b></p> <p>The Ballistic Drop Compensation (BDC) reticle consists of a 1-mil duplex center crosshair surrounded by four 0.5-mil gaps for target identification and continues with mil-dot pattern extending out to 4 Mil in each direction. The horizontal crosshair is 10 Mils in total from side to side. The vertical BDC aiming points are 1/2 Mil in diameter and spaced 1 Mil apart for range estimation and trajectory hold-over to accommodate a variety of calibers.</p>
<p><b>MIL-DOT RETICLE</b></p> <p>Mil-dot reticle including wire and etched reticle, is the most widely used reticle on Leapers riflescopes which provides range estimating capability. The reticle has a big crosshair throughout the reticle and multiple dots spread equally apart on the lines in the central area. The distance between two adjacent dots is designed to be 1 milli-radian or 3.44MOA at 10X.</p> <p>The regular mil-dot reticle on the market usually have 4 dots on each direction. Leapers scopes usually has 6 or 9 dots on each direction to provide more flexibility in range estimating. For mil-dot reticle with 9 dots on each direction, if you count the 2 inner tips of the opposite crosshairs, there are 19 aiming points or totally 21 including the inner tips.</p>	

### Zeroing the Pro 5-Step Reticle Scope:

Follow the steps below to zero a scope with Pro 5-step Reticle on a crossbow:

1. Place a target 10 yards away, aim at the center of the target with the center crosshair and sight in. (Please refer to the Zeroing section for W/E adjustment)
2. Once sighted in at 10 yards, the center crosshair/line will be zeroed in at 10 yards, depending on your crossbow and arrow. The 2nd descending crosshair/line should be accurate at approximately 20 yards, the 3rd descending crosshair/line at approximately 30 yards, the 4th crosshair/line at approximately 40 yards, and the 5th crosshair/line at approximately 50 yards.
3. Walk back 8-10 yards from the sight-in position and fire shots at the center of the target with the 2nd descending crosshair/line until hitting the bulls-eye. Fine-tune the shooting distance back and forth to determine the accurate yardage of the 2nd descending crosshair/line.
4. Perform the same steps for each of the remaining crosshair lines.

### Zeroing the Pro 4-Step Reticle Scope:

Follow the steps below to zero a scope with Pro 4-step Reticle on a crossbow:

1. First of all, adjust the speed dial ring on the scope to match the speed of your crossbow (275 to 385 feet per second).
2. Place a target 20 yards away, sight the crossbow in using the top horizontal line/point. (Please refer to the Zeroing section for W/E adjustment).
3. Once sighted in at 20 yards, the top horizontal line/point will be zeroed in at 20 yards. The next line/point should be accurate at approximately 30 yards, the 3rd line/point at approximately 40 yards, and the 4th floating point at approximately 50 yards.
4. Fine-tune your scope settings at the 30, 40 or 50-yard line/point using the scope's speed dial. If you are hitting high at the 30, 40 or 50-yard distances, adjust the speed dial ring towards a higher speed level. Or, if hitting low, adjust the dial ring towards a lower speed level. Adjust until hitting the bulls-eye.

### Mil-Dot Range Estimating:

1. 1 mil in a scope reticle is the distance from the center of one dot to the center of the next dot.
2. Range estimating requires common knowledge/experience about your target's actual width or height.
3. Set your scope at 10X or the biggest power if its highest magnification is less than 10X. View the target through the scope. Place the center of the dot against one edge of the target and measure to the opposite edge of the target.
4. Once the target has been measured in mils, a formula is available to estimate the distance of the target.
5. Each mil-dot scope comes with a mil-dot card showing the particular formula applicable to that scope and a pre-calculated mil-dot table of most used distance estimates to aid the user.

### Mil-dot Range Estimating Example:

(The formula is for illustration purposes only. For your mil-dot scope, use the formula on your mil-dot card.)

For example, based on past experiences, the length of a known animal from shoulder to tail is 40 inches (1.016 meters), and we see through a scope at, for example, 9X to find that the animal occupies 9 mils. Therefore, the distance can be derived from using the following formula -

$$\frac{\text{Height or Width of Target in Meters} \times 1,000}{\text{Height or Width of Target in Mils}} \times \frac{\text{Magnification}}{10} = \text{Range in Meters (1 M = 1.0936 Yards)}$$

Hence, (1.016 x 1,000/9) X (9/10) = 101.6 meters (110Yds).

Armed with this knowledge, you can compensate for the bullet's drop accordingly and know "great things happen!"

## E. ADJUSTING DIOPTR (Eye Piece Adjustment)

Dioptr adjustment provides additional focus adjustment to adapt the scope to your eyesight.

1. Dioptr adjustment ring is located at the ocular end of the scope. Point the scope at an uncluttered and light colored background object, such as a white wall. Look through the scope and turn the dial ring clockwise or counter-clockwise until the reticle looks the sharpest to you at the first glance.



- 2. Note:** Different individuals will have different eye focus which will result in different dioptr setting. A person will use different dioptr settings with or without eye glasses.

## F. INSTALLING BATTERY

(For Reticle Intensified Models Only)



F-1. EZ-TAP

F-2. Side Rheostat

1. The battery is housed inside the EZ-TAP Battery housing or the side wheel red/green illumination rheostat.
2. Firmly hold the housing or the rheostat with 2 fingers.
3. Use your other hand to unscrew the top cap of the battery compartment.
4. Verify the battery included with your scope. It is either CR2032, CR1632 OR CR1620. Remove the old battery(if there is one) and install a new one of the same type. Make sure the positive (+) side is facing up or out.
5. Replace the cap and screw it clockwise to tighten.

## G. ADJUSTING RETICLE ILLUMINATION

(For Reticle Intensified Models Only)



G-1.

Standard Rheostat

G-2.

Compact Rheostat

G-3.

EZ-TAP® Console

### G-1 and G-2 Illumination Adjustment

Dial the Rheostat to turn on the illumination and verify its color and brightness at each position.

### G-3 Illumination Adjustment (IE® Models)

#### Memory Feature

When turned on, G-3 illuminated reticle shows the same color and brightness you last used.

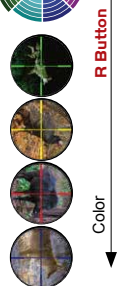

### Turn On/Off

1. Press either the **G** or **R** button to turn on the light.
2. Press and hold either the **G** or **R** button for 1 second to turn off the light.
3. Light will go off after 1 hour with no action.

### Operating in the RGB Mode

1. Press the **R** button to turn the red light on or to change brightness of the red light.
2. Press the **G** button to turn the green light on or to change brightness of the green light.

### Switching between RGB and Multi-Color Modes for IE Models

1. Press BOTH **G** & **R** buttons at the same time for less than 1 second.

### Operating in Multi-Color Mode for IE Models

1. Press the **R** button to change the color along the color axis in the Color Index Table.
2. Press the **G** button to change the color along the intensity axis in the Color Index Table.

Color Index Table

G Button		Intensity →			
Magenta	Thistle	Plum	Violet	Orchid	Purple
Pink	Rosy Brown	Coral	Crimson	Brown	Maroon
Yellow	Khaki	Orange	Golden Rod	Chocolate	Olive
Law Ngreen	Plae green	Spring Green	Olive Drab	Sea Green	Forest Green
Cyan	Azure	Turquoise	Cadet Blue	Dark Cyan	Teal
Blue	Skyblue	Dodger Blue	Indigo	Midnight Blue	Navy

## H. ADJUSTING MAGNIFICATION

(For Variable Power Models Only)

1. For variable power scopes, there is a power ring in front of the eyepiece assembly. To change magnification, turn the ring to align the desired number on the ring with the index dot on the main tube.
2. The lower power provides wider field of view for quick aiming at close range. The higher power is for precise long-range aiming. When the numbers on the ring are not visible under low light condition, turn the ring left to increase the power, turn the ring right to decrease the power.

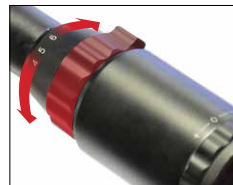

H-1. Adjusting Power Ring

- 3. Note:** Never loosen the screw in the power ring. Doing so will break the sealed state of the scope and destroy the fogproof feature. The power ring should not be disassembled. Do not try to lubricate it. Any such action will void the warranty.



H-2. Power Ring Screw



## I. ADJUSTING PARALLAX

(For Models with Adjustable Objective Only)



I-1.  
Front AO  
Adjustment



I-2.  
Side Wheel  
Adjustable Turret  
(SWAT AO)



I-3.  
SWAT AO  
Big Wheel  
(Optional)

1. Find the proper type of dial from the images above.
2. Aim the scope at your target.
3. Dial the Parallax Adjustment Ring, Side Wheel or Big Wheel, depending on what is available on your model, to the desired distance setting until the target is in the sharpest focus and the center of the crosshair stays on the target while you examine the image by slightly moving your head.

## J. ZEROING

The purpose of zeroing the scope is to ensure that the scope is aligned with the impact point of the pellet or bullet from the rifle. Before zeroing the scope, read the following adjustment knob instructions carefully.

**Note:** For crossbow scopes with PRO 5-STEP and PRO 4-STEP Reticle, please also refer to Section D for more reticle-specific zeroing details.



J-1.  
Sniper W/E



J-2.  
TF2+ Tool-free W/E



J-3.  
Coin-dial W/E



J-4.  
True Hunter W/E  
(Turret Color  
May Vary)



J-5.  
Finger Adjustable  
W/E



J-6.  
Lockable W/E  
(Turret Color  
May Vary)

**Note:** Each click of adjustment for the windage or elevation knob moves the impact point by the amount shown in the table below:

DISTANCE	Inches of Movement per Click @ 100 Yards in Windage/Elevation		
	1/2" Per Click	1/4" Per Click	1/8" Per Click
25 yds	1/8"	1/16"	1/32"
35 yds	7/40"	7/80"	7/160"
50 yds	1/4"	1/8"	1/16"
100 yds	1/2"	1/4"	1/8"
200 yds	1"	1/2"	1/4"

**Note:** Since climatic conditions such as altitude, temperature, wind and rain can affect the pellets or bullets trajectory, you may experience some deviation in the exact settings during different shooting sessions.

### ★ J-1 Sniper W/E Operation

1. The Windage and Elevation Adjustment Target Knobs have a unique Resetting Screw design. An Allen wrench is provided with the scope for adjustment.



2. **ZERO LOCKING** (The windage/elevation knobs are in the LOCKED position for a new scope out of the factory.)

Finger tighten the Zero Locking Ring by rotating clockwise by 40 - 70 degrees. Do not over-tighten. When the Zero Locking Ring is tightened, the windage or elevation adjustment knob is "locked". The knob will not rotate, preventing any accidental movement to lose zero.

3. **ZEROING**

Un-lock the adjustment knobs by turning the Zero Locking Ring counter clockwise by 40 - 70 degrees. Now, Windage/Elevation adjustment knobs can be rotated.

#### i. Zeroing with a Bore Sighter

- a. Follow the instructions that came with your bore sighter and install it in the muzzle of your rifle lining it up with the scope as close as possible.
- b. Pull the windage/elevation knob out for adjustment.
- c. Sighting through the scope as though you were going to shoot and dial the knobs to make adjustment for the windage or elevation until the crosshair matches the bore sighter.
- d. Push the windage or elevation knob down to lock the zero position.
- e. Remove the bore sighter from the muzzle. You are ready for zeroing the target.

## ii. Zeroing on the Target

- Place a target 100 yards away. (35 yards for airgun scopes)
- Ideally, use a steadying device such as a bipod or shooting stand, set the scope at the highest magnification, aim at the center of the target and fire a test shot, if safe to do so.
- If the impact point of the pellet or bullet is exactly in the center of the target then the scope is zeroed. If it is not, you will need to adjust the reticle using the elevation and/or windage adjusters as follows:
  - Vertical Adjustment (Elevation) - Use your fingers to turn the adjusting knob as required. One click in either direction equals approximately 1/2, 1/4 or 1/8 inch at 100 yards (check exact specifications for your scope).
  - Horizontal Adjustment (Windage) - Use your fingers to rotate the adjusting knob as required. One click in either direction equals approximately 1/2, 1/4 or 1/8 inch at 100 yards (check exact specifications for your scope).
- Having adjusted the windage and elevation as required, fire, if safe to do so, another test shot. Keep adjusting and test firing until the test shot impacts on the center of the target when the reticle is on the center of the target. This is vital for accurate shooting.

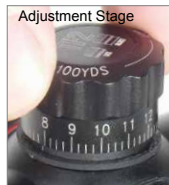

- The Windage and Elevation Adjustment Knobs have a unique 2-stage Tool-free design. The windage/elevation knobs are in the "locked" mode on a new scope out of the factory. Pulling the knobs upward allows for windage/elevation adjustment.
- ZERO LOCKING** (The windage/elevation knobs are in the LOCKED position for a new scope out of the factory.)

When the adjustment knob is pushed down, the knob is "locked" and cannot be rotated. This will prevent any accidental movement to lose zero.

**Note:** To lock an adjustment knob requires proper gear engagement internally. Before pressing the knob down to lock, use minor force to push to get the feel of resistance. If tough to push down, make very slight rotational adjustment (no clicking) to locate the right position to press down. DO NOT force the lock-down.

## 3. ZEROING

Pull up the windage and elevation adjustment knobs to allow for adjustment.

### i. Zeroing with a Bore Sighter

- Follow the instructions that came with your bore sighter and install it in the muzzle of your rifle lining it up with the scope as close as possible.
- Pull the windage/elevation knob out for adjustment.
- Sighting through the scope as though you were going to shoot and dial the knobs to make adjustment for the windage or elevation until the crosshair matches the bore sighter.
- Push the windage or elevation knob down to lock the zero position.
- Remove the bore sighter from the muzzle. You are ready for zeroing the target.

### ii. Zeroing on the Target

- Place a target 100 yards away (35 yards for air gun).
- Ideally, use a steadying device such as a shooting stand or bipod, set the scope at the highest magnification, aim at the center of the target, fire a test shot, if safe to do so.
- If the impact point of the pellet or bullet is exactly in the center of the target then the scope is zeroed. If not, you will need to adjust the reticle using the elevation and/or windage adjustment as follows:
  - Vertical adjustment (Elevation) – Use your fingers to turn the adjusting knob as required. One click in either direction equals approximately 1/2, 1/4 or 1/8 inch at 100 yards depending the model.
  - Horizontal adjustment (Windage) - Use your fingers to rotate the adjusting knob as required. One click in either direction equals approximately 1/2, 1/4 or 1/8 inch at 100 yards depending the model.
- Having adjusted the windage and elevation as required, fire, if safe to do so, another test shot. Keep adjusting and test firing until the test shot hit the target center.
- Now the scope should be zeroed. Make sure to lock both elevation and windage knobs.

## 4. ZERO RESETTING

Once your scope is zeroed, rotate the Zero Locking Ring to lock zero. The "0" marking may not be facing you at the original center position now. Optionally, you can use the following steps to Reset Zero by rotating the "0" marking to the center positions:

- Ensure zero is "locked".
- Use the Allen wrench to turn the Zero Resetting Hex Screw by 180-360 degrees to dis-engage the W/E knobs. (IMPORTANT: Be gentle with the screw movement. Do not over extend the rotation. Stop when meeting resistance in the rotation)
- When the W/E knob is dis-engaged, rotating the knob will not produce any clicking sound and will not affect zero. You can re-position the "0" marking to the center position. (If you get clicks when rotating the W/E knob, the knob was not properly dis-engaged. You need to go back and re-start from zeroing the scope before you lock zero and do zero-reset again.)
- Before tightening the Zero Resetting Hex Screw, turn the Zero Locking Ring counter-clockwise by 40-70 degrees to un-lock zero.
- Be careful to keep the W/E knob still now that it is un-locked. Use the Allen wrench to gently tighten down the Zero Resetting Hex Screw to complete Zero Resetting. (If you get clicks while tightening the screw, you will need to go back and re-start from zeroing the scope before you lock zero and do zero-reset again.)
- IMPORTANT: Rotate the Locking Ring clockwise to lock zero immediately.

**Important Note:** When turning the Zero Resetting Screw loose to dis-engage W/E, zero has to be "locked". When tightening the Zero Resetting Screw to engage W/E, zero cannot be locked. Scope damage may occur if the steps are not followed.

#### 4. ZERO RESETTING

Once your scope is zeroed, push down both knobs and make sure they are fully locked. The "0" marking may not be facing you at the original center position now. Optionally, you can use the following steps to reset zero by rotating the "0" marking to the center positions:



- i. Use the Allen wrench provided to turn **both** Zero Resetting Hex Screws on the side of the knob counterclockwise for 1 to 2 turns to dis-engage the W/E knobs. When a knob is "dis-engaged", the top cap of the knob can freely spin without reticle movement. (IMPORTANT: Be gentle with the screw movement. Do not over extend the rotation. Stop when the W/E knob is dis-engaged)
- ii. When the W/E knob is dis-engaged, rotating the knob will not produce any clicking sound and will not affect zero. You can re-position the "0" marking to the center position. (If you get clicks when rotating the W/E knob, the knob was not properly dis-engaged. You need to go back and re-start from zeroing your scope before you lock zero and do zero-reset again.)
- iii. Use the Allen wrench to gently tighten down the Zero Resetting Hex Screws to complete Zero Resetting. (If you get clicks while tightening the screw, you will need to go back and re-start from zeroing your scope before you lock zero and do zero-reset again.)

#### ★ J-3, J-4, J-5 W/E Operation

##### WINDAGE/ELEVATION DIALING INSTRUCTION



**J-3.**  
Use a flat head screwdriver to adjust the windage and elevation.



**J-4.**  
Apply gentle force on the rim and dial the knob.



**J-5.**  
Apply gentle force on the plastic tab and dial the knob.

1. **ZEROING** - Unscrew and remove the cap of the adjustment knob. Put the cap away in a safe place.
  - i. Zeroing with a Bore Sighter
    - a. When the turret is ready for adjustment, you will be able to dial and have a clear audible click.
    - b. Follow the instruction of your bore sighter and install it in the muzzle of your rifle, lining it with the scope as closely as possible.
    - c. If applicable, turn on the illumination and set it at your preferred color and brightness.
    - d. Sighting through the scope as though you were going to shoot and dial the knobs to make adjustment for the elevation and/or windage until the crosshair matches the bore sighter.

- ii. Zeroing on a Target
  - a. Place a target 100 yards away (35 yards for air gun).
  - b. Use a steady eye device such as a shooting stand or bipod, set the illumination to your prefer settings, aim at the center of the target and fire a test group shot, if safe to do so.
  - c. If the impact point of the test shot is exactly in the center of the target then the scope is zeroed. If not, you will need to adjust the reticle using the elevation and/or windage adjustment. Follow the Point of Impact (POI) direction on the turret to dial the knob accordingly.
  - d. Having adjusted the elevation and windage as required, fire, if safe to do so, another test group. Keep adjusting and test firing until the test shot hit the target center in an acceptable small grouping.
- iii. Now the scope should be zeroed. Make sure to replace both elevation and windage knob caps.

#### ★ J-6 Lockable W/E Operation

1. The Windage and Elevation Adjustment Target Knobs have a unique Locking Screw design. An Allen wrench is provided with the scope for adjustment.

##### WARNING:

DO NOT over-loosen the locking screws! It may cause the face cover to fall off if screws are backed out too far. If, by mistake, the face lid fell off when you were loosening the screws, please follow instructions below to replace the face cover.

- A. Lock both screws down, making sure that they are flush with the surface.
- B. Apply a little loctite or similar adhesive on the flat surface of the knob. Make sure that no adhesive gets into the screw holes or onto the screws.
- C. Carefully place the face cover back on the knob and align with the locking holes properly. Firmly press the face cover to achieve full contact and wait a few seconds to let the cover adhere to the flat surface of the knob.

2. **ZERO LOCKING** (The windage/elevation knobs are in the LOCKED position for a new scope out of the factory.)

- i. Unscrew and remove the cap of the adjustment knob. Put the cap away in a safe place. Gently dial the knob and test if it is locked. If not, you can skip section ii.
- ii. To Unlock: Locate the two locking screws as shown on the right. Use the included small Allen wrench to unlock both locking screws by turning them counterclockwise 1/4 revolution.
- iii. To Lock: Use the included small Allen wrench to fully lock down both screws by turning them clockwise. It is recommended that you gradually lock both screws alternately until they are fully and evenly locked.



### 3. ZEROING - Unlock the adjustment knob to allow for adjustment.

- i. Zeroing with a Bore Sighter
  - a. When the turret is ready for adjustment, you will be able to dial and have a clear audible click.
  - b. Follow the instruction of your bore sighter and install it in the muzzle of your rifle, lining it with the scope as closely as possible.
  - c. If applicable, turn on the illumination and set it at your preferred color and brightness.
  - d. Sighting through the scope as though you were going to shoot and dial the knobs to make adjustment for the elevation and/or windage until the crosshair matches the bore sighter.
- ii. Zeroing on a Target
  - a. Place a target 100 yards away (35 yards for air gun).
  - b. Use a steady device such as a shooting stand or bipod, set the illumination to your prefer settings, aim at the center of the target and fire a test group shot, if safe to do so.
  - c. If the impact point of the test shot is exactly in the center of the target then the scope is zeroed. If not, you will need to adjust the reticle using the elevation and/or windage adjustment. Follow the Point of Impact (POI) direction on the turret to dial the knob accordingly.
  - d. Having adjusted the elevation and windage as required, fire, if safe to do so, another test group. Keep adjusting and test firing until the test shot hit the target center in an acceptable small grouping.
  - e. Now the scope should be zeroed. Make sure to lock both elevation and windage knobs and replace the knob caps.

## K. REMOVING AND INSTALLING LENS CAPS

(For Models with Detachable Lens Caps Only)

Lens caps are designed with grooved inner surface to tightly fit over the scope objective and eyepiece.



1. To remove, grab the lens cap firmly and pull it off the scope. Wiggle the cap gently if necessary to help slide it off.
2. To install, align grooves in the cap with the scope surface and gradually push the cap toward the scope until it is completely seated.

## L. INSTALLING SUNSHADE

(For Models with Detachable Sunshade Only)

1. Remove lens cap on the objective lens.
2. Unscrew the Objective Lens Protective Ring off the objective. (Not all models come with this ring. Skip this step if not applicable.)
3. Screw on a compatible sunshade to the front of the objective. Make sure it is tightened and fully secured.
4. Screw the Objective Lens Protective Ring onto the front of Sunshade. (Skip this step if not applicable.)



## M. CARE AND MAINTENANCE

1. Take care not to drop or knock the scope once it is zeroed.
2. Keep the protective lens covers in place when the scope is not being used.
3. Maintain the metal surface of the scope by removing any dirt or sand with a soft brush so as to avoid scratching the finish.
4. Wipe the lens with a clean flannel cloth to keep it clean and dry. In order to avoid scratching the glass, ensure both the lens and cloth are clean. Do not use finger or finger nail to touch/clean lenses.
5. Store the scope in a cool dry place when not in use. Be careful to avoid contact with acid, alkaline or corrosive chemicals. Remove battery if the scope is being stored away for an extended period of time.
6. Do not attempt to lubricate any part of the scope.
7. Do not disassemble the scope. Do not loosen or remove screws or parts. Any such or similar actions will void the warranty.

**CAUTION:** Viewing the sun can cause serious eye injury. Never look directly into the sun with this or any scope.

## N. LIMITED LIFETIME MANUFACTURER'S WARRANTY

Warranty against material or workmanship defects applies based on the following conditions -

- Scope was purchased new. Evidence of purchase is required for warranty service.
- Scope was not disassembled, parts / screws not removed or loosened, and the scope was not tampered with in any way. Any evidence of such interference will void the warranty.
- Scope has not been abused, maliciously damaged or treated in a manner not in keeping with the purpose it was designed for.

For warranty service, please contact the scope distributor and provide a written problem description to obtain a Return Authorization Number before returning the product for repair or replacement.

# EXPLORE MORE AT

[WWW.LEAPERS.COM](http://WWW.LEAPERS.COM)

Leapers, Inc., headquartered in Michigan, U.S.A., has been in the business of supplying shooting, hunting and outdoor gear since 1992. We set un-compromised high standards for all of our business operations. Our goal is to provide a total solution for any line of products we offer. We pay close attention to industry trends and customer feedback, with a focus on making the best-in-class niche products available for hunting, shooting and outdoor enthusiasts like you.



[www.LEAPERS.com](http://www.LEAPERS.com)  
32700 Capitol Street  
Livonia, MI 48150 U.S.A.  
Tel:(734)542-1500  
Fax:(734)542-7095  
Email:office@leapers.com