

USER GUIDE

TITAN™

FOR GB V2

LAST UPDATE ON JUNE 20, 2017

WWW.GATEE.EU



TABLE OF CONTENTS:

1. Introduction	3
1.1 TITAN kits	4
1.2 Tactical Programming Card and USB-Link – comparison	6
1.3 Basics	7
1.4 Safety summary	8
2. TITAN Drop-in Module	9
2.1 Specification	9
2.2 Sensors	10
2.3 Functions	11
2.4 Installation	15
2.5 First run	26
3. USB-Link	27
3.1 General information	27
3.2 Installation	27
3.3 Troubleshooting	28
4. GATE Control Station (GCS)	29
4.1 General information	29
4.2 Updates	29
4.2.1 GATE Control Station update	29
4.2.2 USB-Link update	31
4.2.3 TITAN Drop-in Module: firmware update	32
4.2.4 Tactical Programming Card: firmware update	34
4.3 TITAN Drop-in Module configuration	35
4.4 Sensors	37
4.5 Diagnostic Trouble Codes	38
5. Tactical Programming Card	39
5.1 General information	39
5.2 How to use the Tactical Programming Card	40
5.2.1 Sensors inspection	41
5.2.2 Advanced functions	42
5.2.3 Diagnostic Trouble Codes	42
5.2.4 Indicators	43
5.3 Functions	44
5.3.1 Standard functions	44
5.3.2 Advanced functions	46
6. Troubleshooting	47
6.1 Motor vibrations	47
6.2 Trouble codes and warnings (DTC)	49
6.3 Frequent problems	53
7. Warranty policy and legal aspects	54

1. INTRODUCTION

Congratulations on your new TITAN, the first in the world drop-in AEG Control System with 8 optical sensors. TITAN will transform your AEG into an advanced training weapon system. Gain a tactical advantage thanks to the extremely fast trigger response, with an option of adjusting the AEG for each mission with 20 functions. Give your AEG a new lease of life!

Configure your TITAN in the field using the outstanding Tactical Programming Card or simply update the firmware and adjust the settings using the USB-Link and the GATE Control Station computer App

With this guide, you will get familiar with all the functions and learn how to use them. Tutorial videos and the most updated version of the guide are available on our website: www.gatee.eu/titan.



1.1 TITAN KITS

TITAN is a modular system which includes:

1. TITAN Drop-in Module (rear or front wired)
2. TITAN Tactical Programming Card
3. USB-Link for GATE Control Station App

You can buy each module separately or altogether as a complete set.



TITAN COMPLETE SET

The complete set version: at once you purchase all you need to take total advantage from TITAN.

Kit contents:

1. TITAN Drop-in Module (rear or front wired)
2. TITAN Tactical Programming Card
3. USB-Link for GATE Control Station App
4. Installation Kit
5. USB Cable
6. Quickstart Guides



TITAN DROP-IN MODULE

The best if you have already bought the TITAN Complete Set but you long for having TITAN in two or more airsoft guns. Then you don't need the second Tactical Programming Card and the second USB-Link from the complete set. This is also suitable for you if you decide to

Programming Card or USB-Link separately, or when you want to have your TITAN installed and set up by an airsoft service and you don't need to change settings.

Kit contents:

1. TITAN Drop-in Module (rear or front wired)
2. Installation Kit
3. Quickstart Guide

Notice: To run and set up the Drop-in Module, it is necessary to have the TITAN Tactical Programming Card or USB-Link.



TITAN TACTICAL PROGRAMMING CARD

Provides you with very easy access to the TITAN functions' settings anywhere you are.

Kit contents:

1. TITAN Tactical Programming Card
2. Quickstart Guide

Notice: TITAN is not compatible with WARFET Tactical Programming Card.



USB-LINK

Allows to connect TITAN to PC in order to use GATE Control Station App.

Kit contents:

1. USB-Link
2. USB Cable
3. Quickstart Guide

1.2 TACTICAL PROGRAMMING CARD AND USB-LINK – COMPARISON

What is the difference between using **Tactical Programming Card** or **USB-Link**?

The main difference is that the **Tactical Programming Card** is small, lightweight and portable. Using **USB-Link with GATE Control Station** gives more functions, including firmware update and requires connection to PC.



Tactical Programming Card



USB-Link

	Tactical Programming Card	USB-Link with GATE-CS
Settings adjustment	+	+
Firmware update	-	+
Portable	+	-
Sensors check	+	+
Diagnostic Trouble Codes	+	+
Statistics	-	+
Additional settings	-	+

1.3 BASICS

- Please read this manual before using the device to ensure safe and proper use.
- Information contained in this document is subject to updating without notice. Please check if you have downloaded the latest manual from the Technical Support section of our website. The Product Warranty Form is also available there.
- GATE Menet, Wojtak Sp. J. does not take any responsibility for damages, injuries and accidents resulting in the use of this product or the use of Air Electric Gun with the product installed.
- You should program your TITAN before the first use.
- Check the availability of TITAN software updates on our website every now and then. Using the most recent software versions ensures stable functioning of the device and allows for taking advantage from all its features.
- This version of TITAN is compatible with most V2 gearboxes.
- The device covers must not be removed by the user (e.g. foil or heatshrink tube).
- In case you have any difficulties while installing or using this product, we recommend to email us at titan@gatee.eu. Our support team will answer all your questions and send you some hints.

1.4 SAFETY SUMMARY

- We recommend that this product should be installed by an experienced airsoft service.
- Before starting installation process, please ensure that your AEG is empty and there are no BBs inside.
- Caution must be exercised to prevent short circuiting the battery as the consequences can be very dangerous (fire, battery explosion, burn).
- **Incorrectly connecting positive and negative battery terminals will cause immediate damage to the drop-in module what is not covered by the warranty and it can lead to fire, burn or even battery explosion.**
- For your own safety, you should install an additional fuse between the battery and the drop-in module. The fuse should be placed very close to the battery. It will protect the battery in case of: (1) incorrectly connecting positive and negative battery terminals; (2) shorting the power cords which connect battery and TITAN; (3) mechanical damage to the drop-in module.
- Do not attempt to connect the battery when the barrel of your AEG is directed toward you, another person or an animal.
- When you use the auto cell detection, ensure that your battery is charged. The cell number may be incorrectly detected if your battery is discharged.
- Before an airsoft game, we suggest to check the most recent configuration and delete the registered Diagnostic Trouble Codes (DTC).
- Prevent the USB-Link and the small end of the cable from contact with conductive materials (e.g. dust, liquid, metal powder).
- Do not store or carry flammable liquids, gases, or explosive materials in the same compartment as the device, its parts, or accessories.

2. TITAN DROP-IN MODULE

2.1 SPECIFICATION

TITAN is an electronic unit installed inside of a gearbox. It replaces the trigger contacts and the cut-off lever, which takes control of your AEG. You can configure your TITAN using the Tactical Programming Card or USBLink with GATE Control Station computer App.



This version of TITAN is compatible with most V2 gearboxes.

PARAMETERS:

Supply voltage: **3.8-17 V**

Current consumption on standby: **280 μ A (depends on battery type)**

Dimensions (max.): **47.4 x 28.7 x 13.5 mm [1.9 x 1.13 x 0.53 in]**

Weight: **27.6 g [0.97 oz]**

TITAN GIVES YOU THE OPTION TO ADJUST:

- Trigger sensitivity
- Pre-cocking mode
- Fire selector mode
- Burst mode
- Rate of fire
- Low battery warning
- Battery protection
- Time delays between shots (sniper delay)

WARNING!

TITAN is compatible with Tactical Programming Card and USB-Link. They enable (among others) settings adjustment and sensors inspection.
In order to install TITAN, you must learn how to use at least one of them.

2.2 SENSORS

TITAN has no less than eight sensors:

- 1 gear sensor
- 2 selector sensors
- 5 trigger sensors

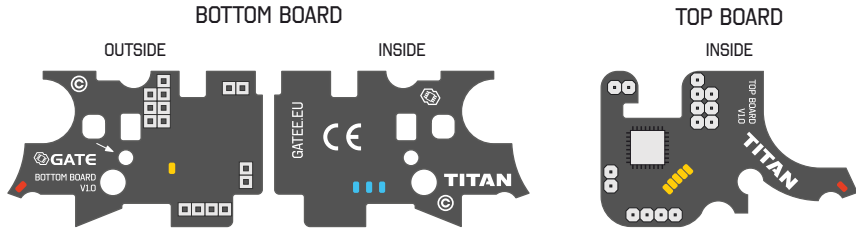

Thanks to the optical sensors we have eliminated the problem of faulty switches that can occur in competitors' drop-in mosfets. The trigger has no mechanical connections with the PCB. This eliminates mechanical stresses and provides for high reliability.

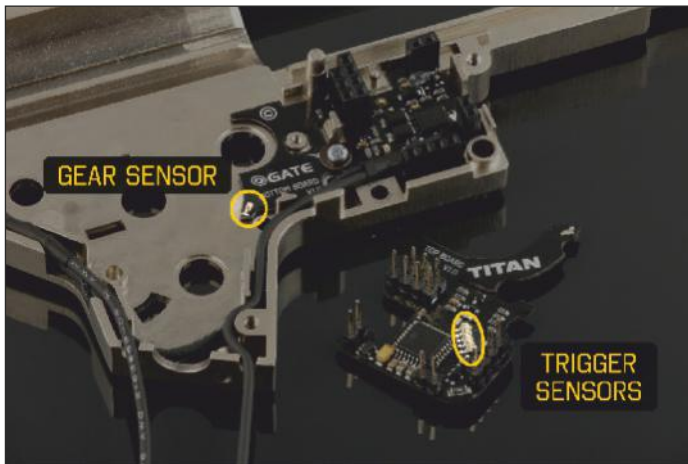

2.3 FUNCTIONS

**TRIGGER SENSITIVITY ADJUSTMENT**

Five trigger sensors allow you to control trigger sensitivity. You do not have to disassemble your AEG. Just use the Tactical Programming Card or the GATE Control Station App to adjust the trigger to your preferences and level of skills.

**CONFIGURABLE FIRE SELECTOR (gen.2)**

Two selector sensors allow you to use up to six fire selector modes, including innovative SEMI-BURST-AUTO mode:

- SAFE-SEMI-AUTO
- SAFE-SEMI-SEMI
- SAFE-SEMI-BURST
- SAFE-BURST-AUTO
- SAFE-SEMI-BURST/AUTO (short press - BURST, long press - AUTO)
- SEMI-BURST-AUTO (SAFE mode via the fast switch SAFE-SEMI-SAFE)

**CYCLE DETECTION**

Thanks to the gear sensor, TITAN precisely detects in which position the cycle should finish. Therefore, even the shortest trigger action produces at least one full cycle.

Thanks to the cycle detection function you get:

- **Automatic BURST** – there is no need to set the burst time. You can set the burst between two and 10 shots;
- **Automatic PRE-COCKING** – Pre-cocking is fully operational in SEMI, BURST and AUTO modes. You can simply set the pre-cocking as high, mid or low;
- **Full cycle** - when the pre-cocking is off, TITAN ensures that the gearbox completes a full cycle. You gain a higher reliability.

**PRE-COCKING (gen.2*)**

Victory in the game is often a matter of fractions of seconds. Thanks to PRE-COCKING, you gain a trigger reaction similar to a real gun. It allows for initial spring compression, which speeds up the trigger response significantly.

There are two **PRE-COCKING MODES**:

- **AUTO MODE** – the spring is automatically compressed after each shot,
- **SMART MODE** – slow trigger action compresses the spring, and fast trigger action fires the shot.

And three **PRE-COCKING BOOST** options: **HIGH / MID / LOW**

**Now the pre-cocking is fully operational in SEMI, BURST and AUTO modes and there is no need to set the pre-cocking boost manually. There is an option to switch the pre-cocking mode via fire selector (p. 44).*

Please note: using PRE-COCKING increases wear and tear on the gearbox.

**BURST (gen.2*)**

The burst enables you to shoot a pre-determined number of BBs, which is very useful in MILSLIM and when using low-caps. The BURST mode is available after setting the proper fire selector mode. There are two BURST modes:

- **FULL** – every, even the shortest trigger action fires the pre-determined number of rounds,
- **TRIG** – releasing the trigger while firing stops the burst sequence.

*There is no need to set burst time. You can easily set burst between two and 10 shots.

**ROF CONTROL**

This enables a reduction in a gun's rate of fire. You use stronger LiPo batteries, and still have a ROF just like in a real gun.

**ROF STAB**

It allows you to change the way the ROF Control works:

ON - ROF Control uses PWM to decrease ROF. Thanks to this gearbox works smoothly what decreases wear and tear of AEG internal parts.

OFF - ROF Control adds breaks between shots to decrease ROF. It gives you more realistic experience.

**SNIPER DELAY**

It lets you to set delay between each SEMI shots to simulate the delay from reload or recoil. You can set 0.5s, 1s, 2s or 3s delay.

**SMART TRIGGER**

We know how vital the fast trigger response is during combat. This is why we have developed the Smart Trigger function. It enables you to achieve a faster trigger response. It works with the ROF Control System. During the first shot, the microprocessor sets the ROF Control to 100%. After the first shot, it switches to a previously programmed value (e.g. 50%). As a consequence, the first shot is fired at a full ROF, and subsequent shots at a reduced ROF. The best results can be achieved by using a battery with a higher than standard voltage. For example, if you use a 7.4V battery, you can replace it with 11.1V. In this way, you will achieve a faster trigger response with the same rate of fire as with a standard battery.

*Works only when ROF STAB is ON.

**AUG MODE**

Enjoy two stage trigger. Activate AUG Mode and set two different trigger sensitivities. Pulling the trigger slightly produces SEMI or BURST fire and pulling the trigger further produces BURST or AUTO fire (depending on the fire selector mode).

**BATTERY PROTECTION (gen.2*)**

Protection against Over-Discharge of the Battery. Modern LiPo and LiFe batteries are very sensitive to over-discharge. If you do not want to damage the battery and you care about its service life, this protection is indispensable. The microprocessor monitors the battery voltage constantly. When the voltage drops down to a critical level, it will not allow firing.

**TITAN detects the number of cells automatically. There is no need to reprogram TITAN every time you replace the battery.*

**LOW BATTERY WARNING**

When the battery cells' voltage drops to a predefined level, the motor will vibrate at regular intervals.

**SMART FUSE**

We have developed an electronic fuse with an accurate current sensor. A combination of current, voltage and temperature measurements makes your AEG installation highly reliable. It protects the MOSFET against overheating, overloading and short-circuiting. If your airsoft gun becomes jammed, the function protects the motor and battery against damage.

**ADAPTIVE ACTIVE BRAKE**

It automatically adjusts the motor's braking power according to your needs. This prolongs the lifespan of the motor.

**MOSFET**

Do you want to achieve a higher ROF and faster trigger response? Are you planning a power upgrade of your gun? In that case, you need a MOSFET.

It targets the energy from the battery directly to the motor, bypassing the mechanical trigger contacts. As a result, you gain a higher ROF of the gun and a faster trigger

**BUILT-IN SELF-TEST**

This allows you to quickly check whether the TITAN is working properly. If any problem occurs, the Diagnostic Trouble Codes will indicate where the problem lies.

**COATING**

Thanks to its special conformal coating, the unit is resistant to atmospheric conditions (Military Specification: MIL-V-173C).

**DEANS-T READY**

The product has factory-fitted low-resistance deans-t connector.

**MINI-TAMIYA ADAPTER**

Thanks to the Mini Tamiya Adapter included in the kit, you can smoothly connect the TITAN to a standard battery.

**14.8V LI-PO READY**

The TITAN can be used with batteries up to and including 14.8V LI-PO. The minimum operating voltage is 3.75V and maximum is 17V.

**PRINTED QUICKSTART**

Make your adventure start more easily with a new product. The quickstart contains basic information and hints.

2.4 INSTALLATION

Please, watch carefully the installation video:



<https://www.youtube.com/gatemovies>

TITAN is an electronic unit installed inside of a gearbox. It replaces the trigger contacts, cut-off lever and safety lever. TITAN is compatible with most V2 gearboxes. Some gearboxes might require modification in order to fit the unit.

Installation Kit contents:



- 01 Selector plate stickers
- 02 Female deans-t connector
- 03 Mini-tamiya adapter
- 04 Motor connectors 2.8 x 0.5 mm [0.11 x 0.02 in]
- 05 0.7mm [0.03 in] screw and washers set
- 06 0.5mm [0.02 in] screw and washers set

YOU WILL NEED:

- cross-head screwdriver
- flat-blade screwdriver
- metal file or milling machine
- solvent
- grease
- programming card or USB-Link and PC

FOLLOW THE STEPS BELOW IN ORDER TO MOUNT THE TITAN DROP-IN MODULE:

- 01 Remove the gearbox from the AEG body.
- 02 Disassemble your gearbox, take out all the internals.
- 03 Clean the gearbox case using solvent.

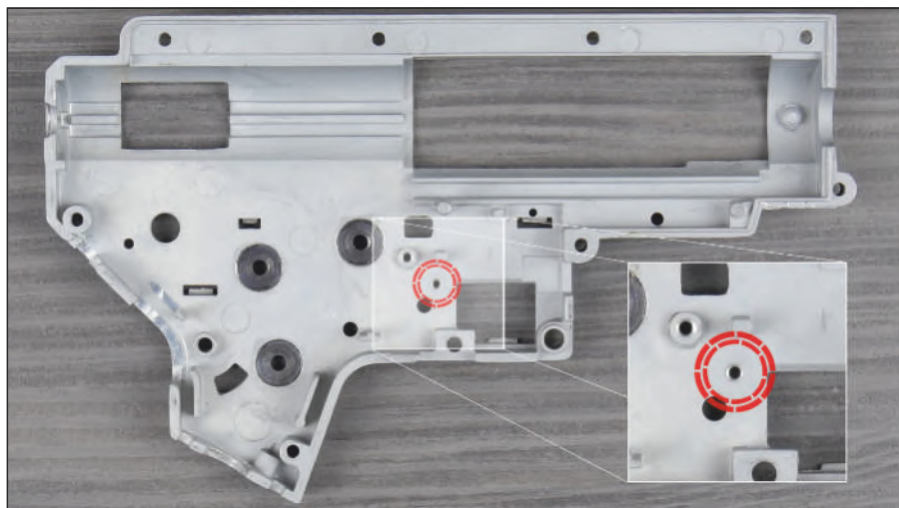

- 04 Pay attention to the marked area. If you see that it is not smooth, use a metal file or grindstone to prepare the surface.
The gearbox surface should be smooth, with no sharp edges which would damage the TITAN.

- 05 Detach the drop-in module carefully.

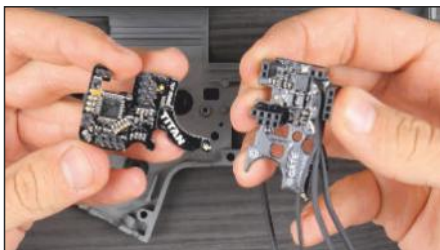

- 06 Place the bottom board on the bottom part of the gearbox. Do not use a screw yet. Check if the bottom board is laid flat in the gearbox.

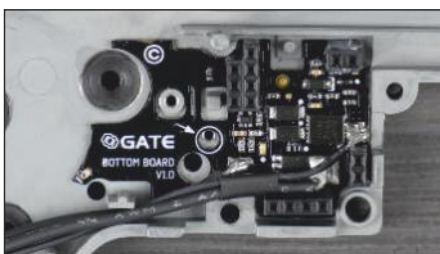

- 07 Make sure the electronic components do not touch the gearbox case.

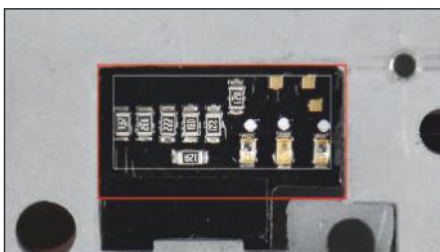

- 08 Use the insulation (black) washer from the kit. **ATTENTION! The insulation washer must protect the circuit board.** The metal screw and metal washer cannot touch the board directly. It can result in short-circuit and TITAN damage which is not covered by the warranty.

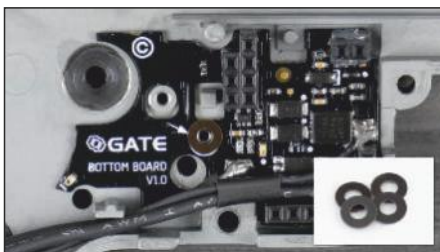

- 09 Screw on the bottom board to the case. Use the original screw or the one from the TITAN kit.

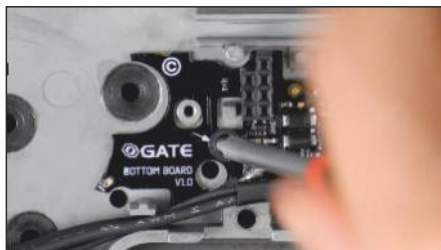

- 10 Check if the screw sticks out of the gearbox.



- 11 If so, add metal washer(s) included in the kit. Make sure that the metal washer is placed between the screw and the insulation washer. It cannot touch the circuit board directly.



CAUTION! Placing the washers in wrong order will cause short circuit and permanent damage to the TITAN, which is not covered by the warranty.

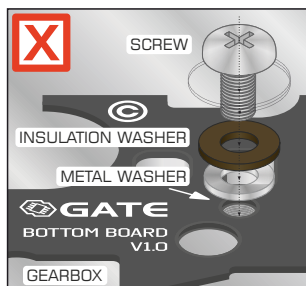
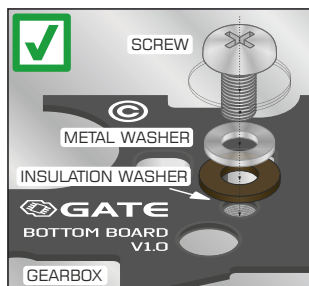

- 12 Check if the top board fits gearbox without any problems.

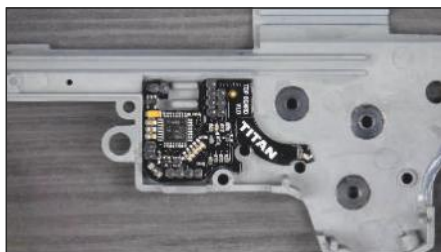

- 13 Loosen the screw. Adjust the position of the bottom board.

The distance between the board and the bearing should be similar as indicated in the marked area.



- 14 Make sure the marked areas are not covered by board or wires.



- 15 Check if sensors are clean and not covered by wires.

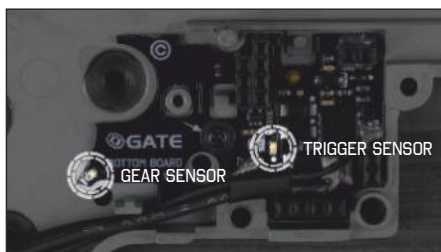

- 16 Some gearboxes need modification. Check if your gearbox has the marked pins. If so, remove them.



- 17 Check if both parts of the gearbox fit together perfectly.

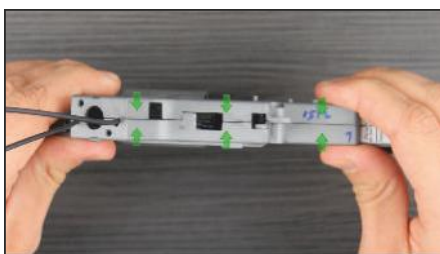

- 18 Mount the trigger without spring. Insert the TITAN top board. Close the gearbox. Carefully check if the trigger moves smoothly and does not touch any TITAN's components.



- 19 Mount the sector gear, trigger with spring and top TITAN board. Make sure that the gear does not touch TITAN.



- 20 Close the gearbox. Tighten two screws on the top part of the gearbox case.



- 21 Prepare selector plate. If selector plate doesn't have copper connector, you need to modify it.
The black surface does not reflect light, so sensors cannot work properly.



- 22 In order to modify the black plate, use the sticker from the installation kit. At first, try to use the 'middle' sticker.



ATTENTION! If the selector plate has copper connector, **do not make any modifications.**

- 23 Black plate after modification.

The sticker location is very important. It should be as close to the left side as possible.



24 Install the selector plate.

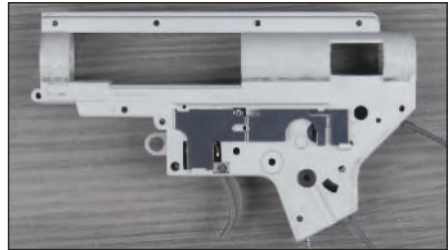

SENSORS' INSPECTION - TACTICAL PROGRAMMING CARD

Connect the programming card to the battery and TITAN

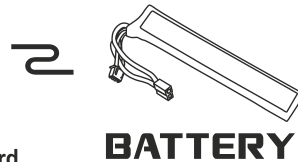
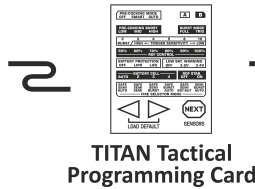
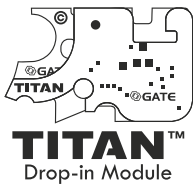

01 Click and hold button **NEXT**. You will see the current state of sensors.



↓ **CLICK AND HOLD**

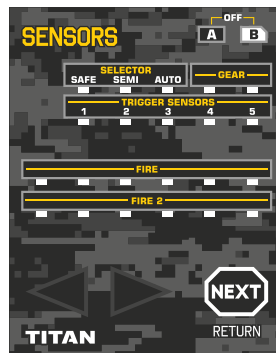
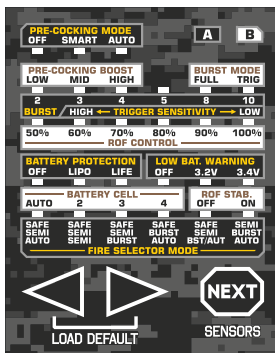

SENSORS' INSPECTION - USB-LINK/GATE CONTROL STATION APP

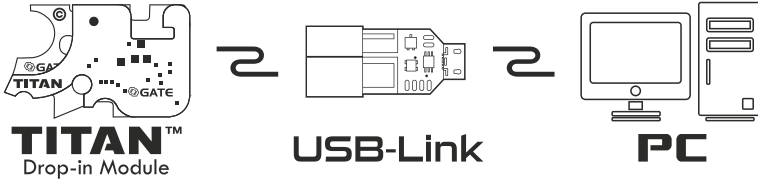

01 Connect TITAN to your PC through USB-Link. Start the GATE Control Station App.

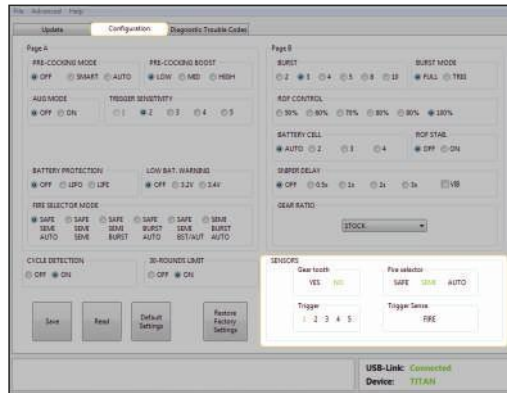

Go to Configuration. You will see the current state of sensors.

For more information, check USB-Link chapter on page 27.

SENSORS' TEST

02



Pull the trigger slowly. The TRIGGER SENSORS LED indicators will light up one by one. They indicate active sensors. In case of some trigger models, first sensors might be active even when the trigger is not pulled.

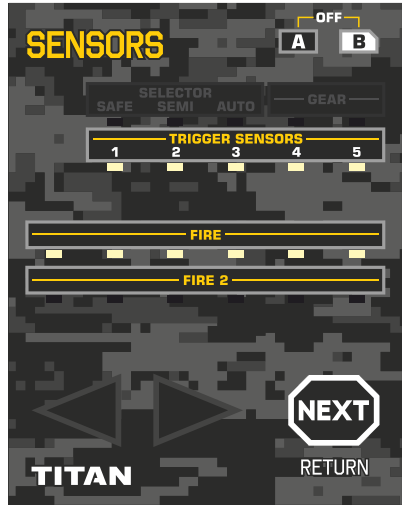

03



Check if the sensors recognize the selector plate. Moving the selector plate, verify if TITAN detects SAFE, SEMI and AUTO.

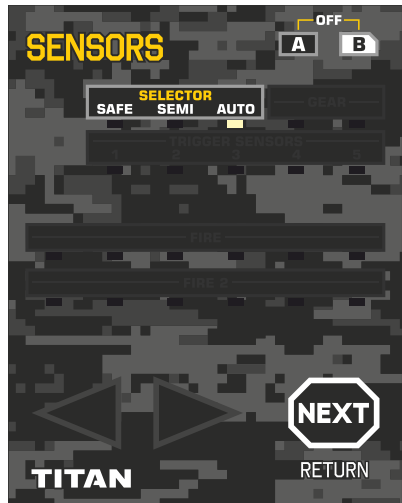

- 04 If all the three LED indicators are ON, this means an error.



This error occurs mostly when selector plate doesn't reflect light (check p. 21). It can also occur if too much light reaches sensors. Then you need to cover the sensors.



Turn the gear slowly to check if the sensor detects teeth.

Keep in mind that the TITAN reads the sensors much quicker than the programming card.

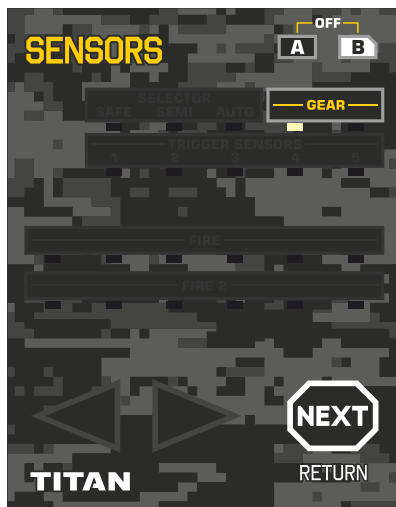

- 06 Insert gearbox into body and check whether the TITAN detects the fire selector position correctly.

Switch should take place approximately halfway between selector positions:

- A) SAFE - SEMI ~45°
- B) SEMI - AUTO ~135°



Otherwise, you need to modify the selector plate with other sticker (p. 21).

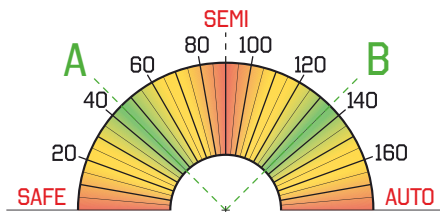

- 07 If all the sensors work flawlessly, you can assemble the gearbox. Do not use too much grease. In a critical situation, excessive grease may cover a sensor.

2.5 FIRST RUN

ATTENTION!

A few initial shots are 'calibration shots'. TITAN adapts to the gearbox configuration. In order to readapt TITAN, you must restore factory settings. This is necessary e. g. if you modified gears ratio or replaced motor.

You have successfully installed the drop-in module. Now it's time to configure your TITAN. Go to the USB-Link chapter (p. 27) or the Tactical Programming Card chapter (p. 39).

REMEMBER! AFTER CONNECTING THE DEVICE THE FIRST TIME, YOU SHOULD:

- download the most updated version of GATE Control Station
- make the firmware update
- configure the gear type (if your gears are not stock)

3. USB-LINK

3.1 GENERAL INFORMATION

USB-Link enables connecting TITAN or Tactical Programming Card to PC. Thanks to this, using GATE Control Station app, you can configure drop-in module and make the firmware update.

PARAMETERS:

Supply voltage: **4.5-5.5 V**

Current consumption (max.): **35 mA**

Current consumption on standby: **0.5 mA**

Dimensions: **31.1 x 14 x 8.4 mm [1.22 x 0.55 x 0.33 in]**

Weight: **3.8 g [0.13 oz]**

3.2 INSTALLATION

USB-Link is compatible with the Windows 7 or newer and most of OS X operating systems.

WINDOWS

Connect the USB-Link to the PC's USB port and wait until Windows will have installed all necessary drivers.

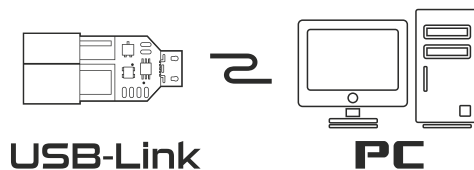

To check if the drivers are installed, press **My Computer** with the right mouse button. Next, choose **Properties** and then **Device Manager**.



Find **Ports (COM and LPT)** and show its contents. If the USBLink was installed properly, you should see the **USB Serial Port** (COM number can vary).

If you cannot see your device on the list or it is accompanied by exclamation mark, it means that you must install the device's driver manually. You can download the driver from here: www.gatee.eu/gcs.

3.3 TROUBLESHOOTING

USB-Link can glow 3 colours: blue, green, red

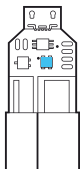

Blue – USB-Link is connected to PC, TITAN or Programming Card is not connected

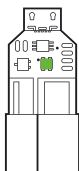

Green – USB-Link is connected to PC and to compatible device

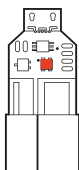

Red – no communication with the device connected to deans-t connector

4. GATE CONTROL STATION (GCS)

4.1 GENERAL INFORMATION

GATE Control Station is a user-friendly computer app which enables firmware update and TITAN configuration. With the app, you can read the Diagnostic Trouble Codes stored in the drop-in module. The full version of GCS will also display interesting statistics e.g. how many BBs you fired.

4.2 UPDATES

4.2.1 GATE CONTROL STATION UPDATE

When you run the app, the most recent GCS updates are being checked automatically. You can also check availability of the newest software versions manually choosing **Check update**.

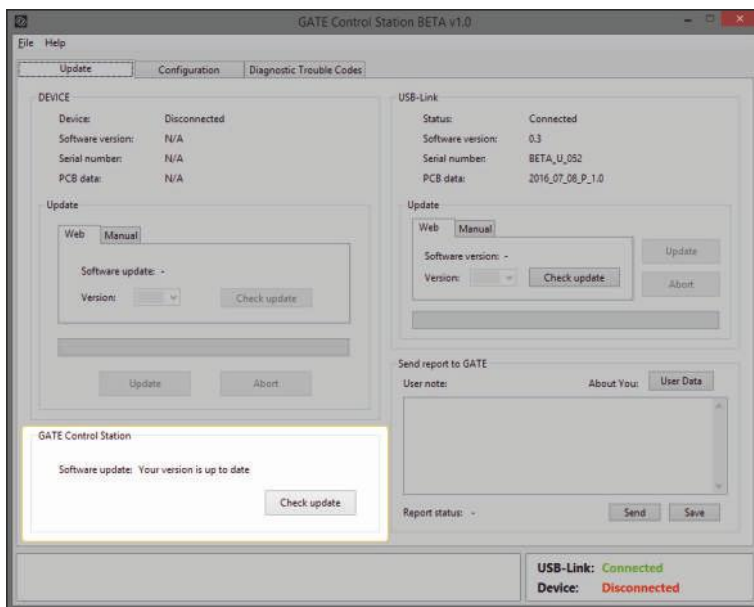

If the new software version is available, you will see an appropriate statement. Choose **Download** to start downloading.



When the downloading is done, unzip the file. The newest software version is ready to use.

4.2.2 USB-LINK UPDATE

In order to update the USB-Link, follow the steps below:

- Connect USB-Link to the USB port of your PC
- Run the GATE Control Station

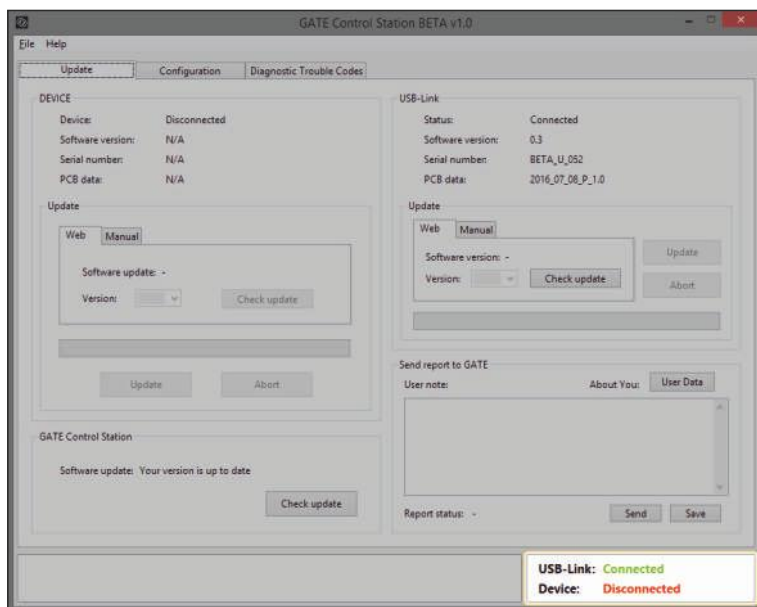

In the bottom right corner you will see **USB-Link: Connected**

- Check availability of updates for the USB-Link choosing **Check update**. If the USB-Link firmware version is outdated, click **Upload** to start updating.

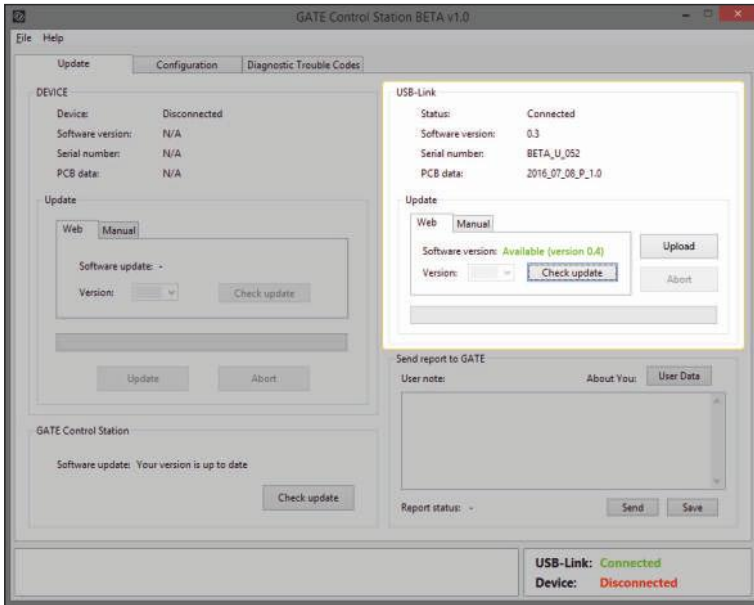

4.2.3 TITAN MODULE: FIRMWARE UPDATE

In order to make update, follow the steps below:

- Connect the TITAN module to USB-Link.

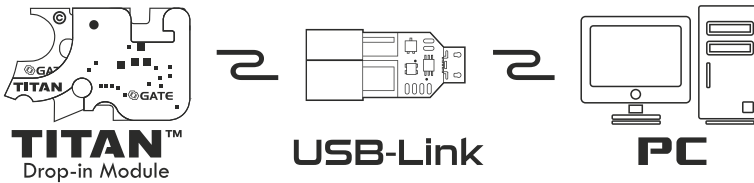

- In the status bar you will see **Device: TITAN**.



- Cascade connection is forbidden (USB-Link->Tactical Programming Card->TITAN).

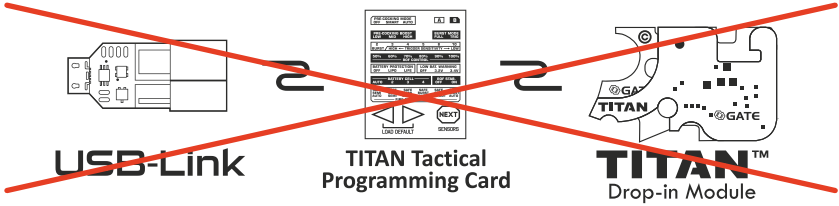

- Check availability of updates choosing Check update. If the current firmware version is outdated, click Update.

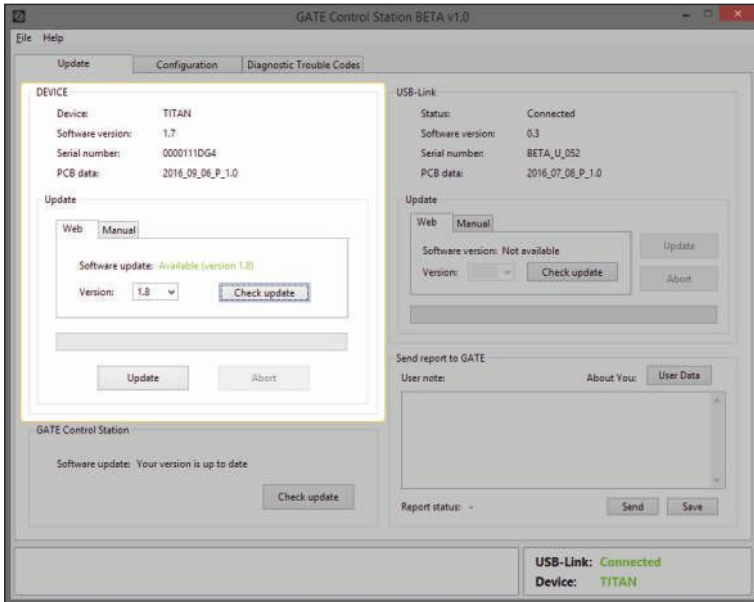

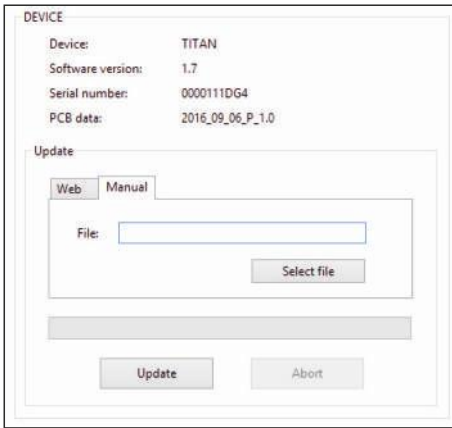

You can also update the TITAN firmware to the version which was downloaded on your computer drive. Choose **Manual**, and indicate the proper file. Click **Upload**.

4.2.4 TACTICAL PROGRAMMING CARD: FIRMWARE UPDATE

In order to update the Programming Card, follow the steps below:

- Connect the Programming Card to USB-Link.

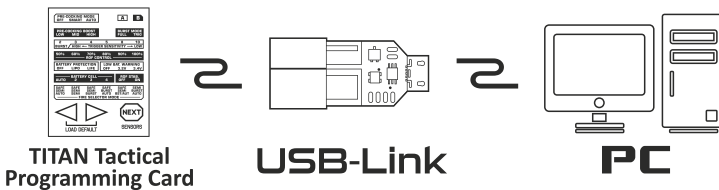

- In the status bar you will see **Device: PROGRAMMING CARD**.



- Cascade connection is forbidden (USB-Link->Tactical Programming Card->TITAN). See diagram on page 33.

- Check availability of the newest firmware versions for the Tactical Programming Card choosing **Check update**. If an update is available, click **Upload** to start firmware updating.

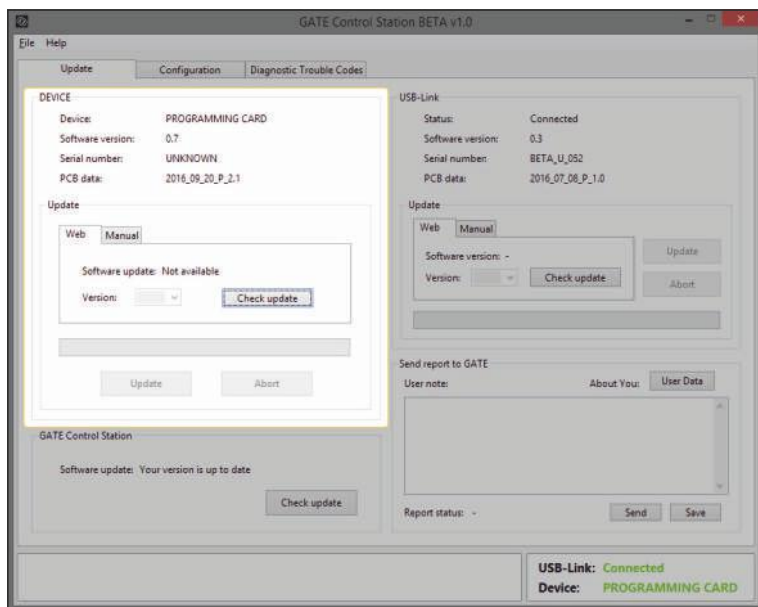

4.3 TITAN DROP-IN MODULE CONFIGURATION

TITAN can be configured according to your preferences. The most convenient method of the device's configuration is the GATE Control Station App.

ATTENTION:

Each time you run the GATE Control Station App, the **default configuration** appears. Click **Read** to check the current configuration.

To modify the already saved configuration, run the GCS and click **Read**. The current configuration will appear. After choosing the preferred options, click Save.

1 You can set the default settings at any time clicking **Default Settings**. Only after choosing **Save**, the default settings will be saved in the TITAN module.

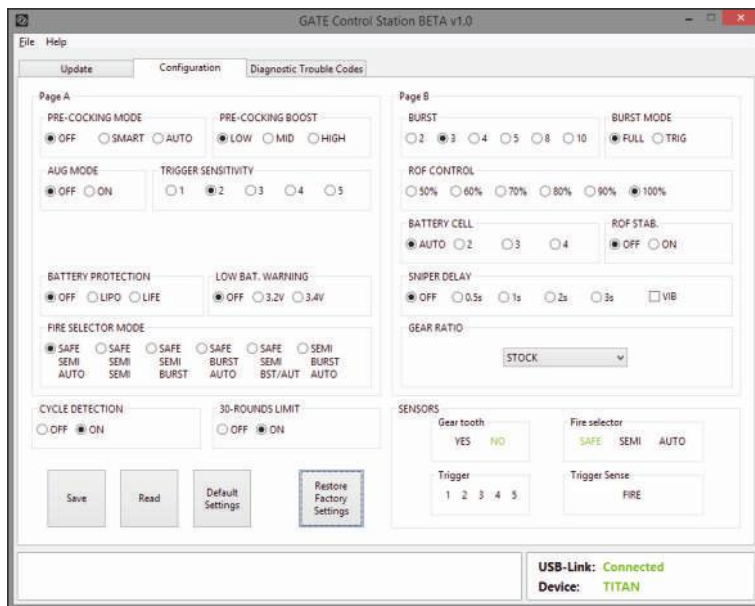

Choosing **Restore Factory Settings** results not only in restoring the factory settings, but also in deleting adaptation and statistical data.

SEE **FUNCTIONS DESCRIPTION** ON p. 44

IMPORTANT:

If you replaced the motor or gears, you must restore factory settings. Then TITAN will readapt cycle detection to the new gearbox configuration.

4.4 SENSORS

Please note that the information about sensors is very useful during the TITAN installation or trigger sensitivity adjustment.

GEAR TOOTH

Shows the gear sensor's functioning. In case of the tooth detection, YES goes green. Detecting a gap between teeth results in NO going green.

FIRE SELECTOR

Shows the current selector position.

TRIGGER

Enables to check trigger sensors (1-5). Some sensors may be active even if the trigger is released (depending on the trigger model).

TRIGGER SENSE

FIRE reflects the moment of firing a shot. It goes green when the trigger will reach the chosen trigger sensitivity. *Does not concern the AUG MODE.*

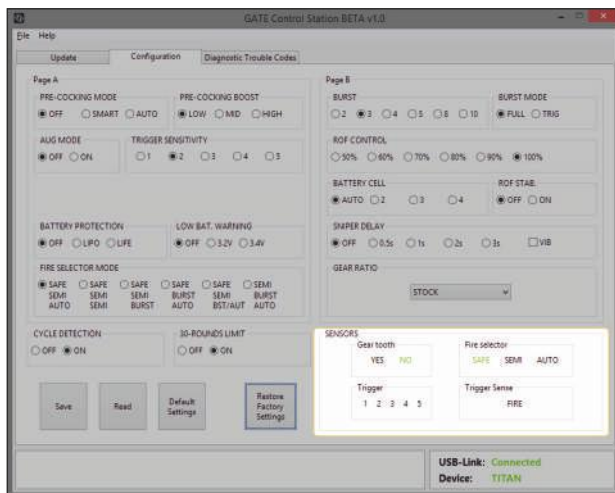

4.5 DIAGNOSTIC TROUBLE CODES

In the **Diagnostic Trouble Codes** window you can check if there are some errors or problems concerning the TITAN module. Each error or warning is automatically highlighted in red as in the screenshot below.

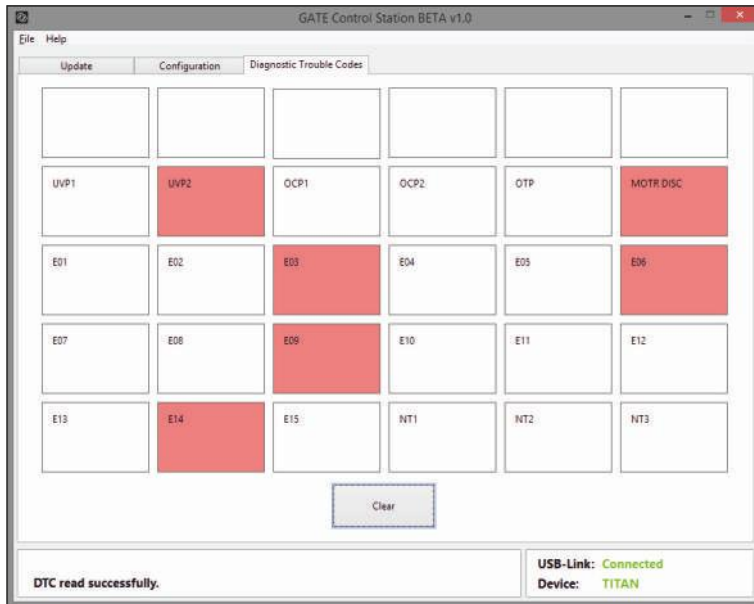

You can clear the codes clicking Clear. Remember to clear DTC after reading. It will help you in future diagnostic.

All the possible DTC are described on page 49.

5. TACTICAL PROGRAMMING CARD

5.1 GENERAL INFORMATION

Tactical Programming Card is an easy-to-use device that allows you for adjusting the TITAN functions not only when you are preparing for a game at home but also in the field. Connecting the card to the TITAN module is very simple: just connect it between your battery and AEG.

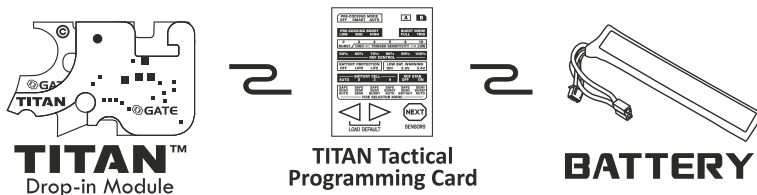

The programmer communicates with the TITAN module automatically and will show its current configuration.

All the LED indicators are blinking until you will connect the programmer to the TITAN.
When the card is connected, you cannot fire the shot.

PARAMETERS:

- Operating voltage: **5-17 V**
- Dimensions: **67 x 53 x 7mm [2.64 x 2.09 x 0.28 in]**
- Weight: **27.6g [0.97oz]**

5.2 HOW TO USE THE TACTICAL PROGRAMMING CARD

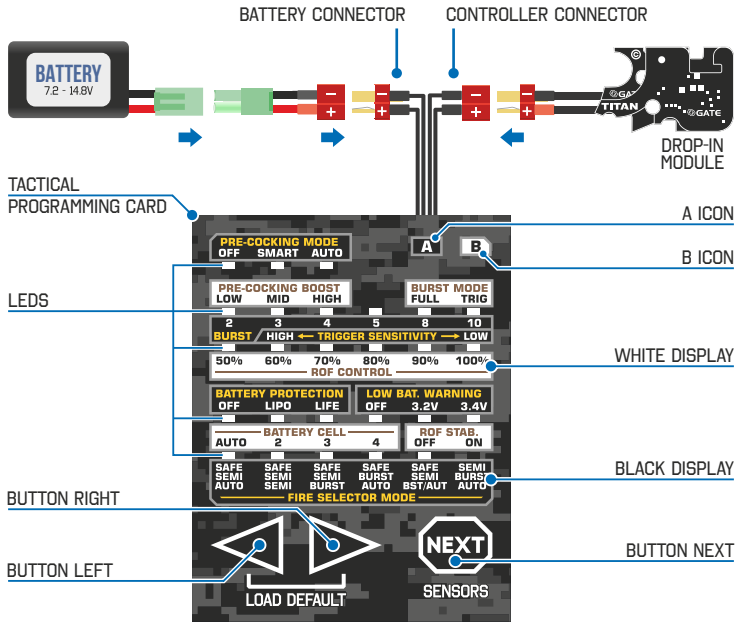

The basic operations and adjusting main settings:

- 01 Connect the battery to the Programming Card. The LEDs light on and start blinking.
- 02 Connect the airsoft gun with TITAN inside to the Programming Card. All current settings are displayed on the corresponding LEDs.
- 03 When the icon **A** is ON, check only on the **black** display of Programming.
- 04 When the icon **B** is ON, check only on the **white** display of the Programming Card.
- 05 Click button **NEXT** to switch between functions and A/B displays.

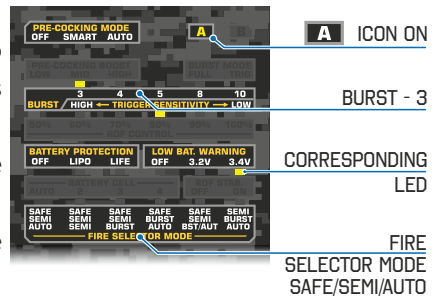

- 06 Click button **LEFT** or **RIGHT** to switch options.
- 07 Click and hold buttons **LEFT** or **RIGHT** to switch options more quickly.
- 08 Before firing, disconnect the Programming Card and connect the airsoft gun to the battery.
- 09 All the settings are saved automatically.
- 10 Click and hold buttons **LEFT** and **RIGHT** to **load default settings**.
- 11 Click and hold buttons **RIGHT** and **NEXT** to **restore factory settings**. It results in restoring default settings for all the functions, deleting adaptations and statistical data.

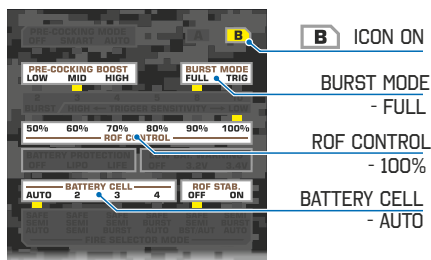

IMPORTANT: If you have replaced the motor or gears, you must restore factory settings. The TITAN will adapt cycle detection to the new gearbox configuration.

5.2.1 SENSORS INSPECTION

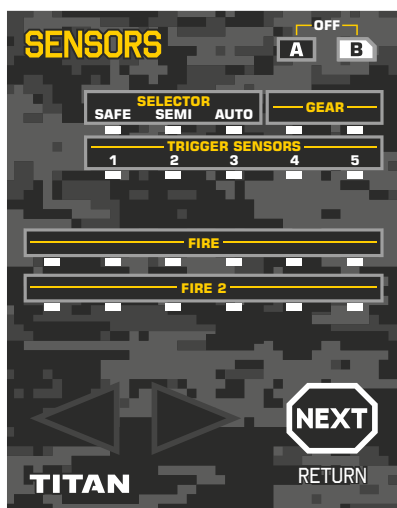

- 01 Click and hold button **NEXT** to switch to SENSORS display.
- 02 TITAN SENSORS are displayed on corresponding LEDs in real time.
- 03 **FIRE** lights up when the trigger sensors detect the preselected trigger sensitivity.
- 04 **FIRE2** lights up when the trigger sensors detect the preselected **AUG MODE** sensitivity (the second stage of trigger).
- 05 Click and hold button **NEXT** to return to the main settings.

5.2.2 ADVANCED FUNCTIONS

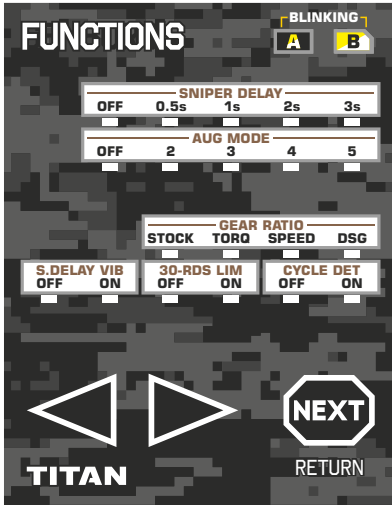

- 01 Click and hold at once buttons **LEFT** and **NEXT** to switch to advanced functions display.
- 02 All current settings are displayed on the corresponding LEDs.

5.2.3 DIAGNOSTIC TROUBLE CODES (DTC)

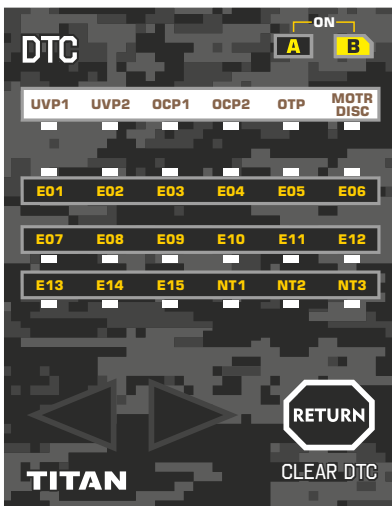

- 01 Click and hold at once buttons **LEFT**, **RIGHT** and **NEXT** to switch to DTC display.
- 02 All the diagnostic trouble codes (since the last clearance) are displayed on the corresponding LEDs.
- 03 Click and hold button **RETURN** (NEXT) for 1.5 second to clear DTC.
- 04 Click button **RETURN** (NEXT) to return to the main settings.

5.2.4 INDICATORS

- | | |
|----|-----|
| A | B |
| ON | OFF |

Display A
- | | |
|-----|----|
| A | B |
| OFF | ON |

Display B
- | | |
|----|----|
| A | B |
| ON | ON |

Diagnostic Trouble Codes Display
- | | |
|-----|-----|
| A | B |
| OFF | OFF |

Sensors Display
- | | |
|-------|-------|
| A | B |
| BLINK | BLINK |

Advanced Functions Display

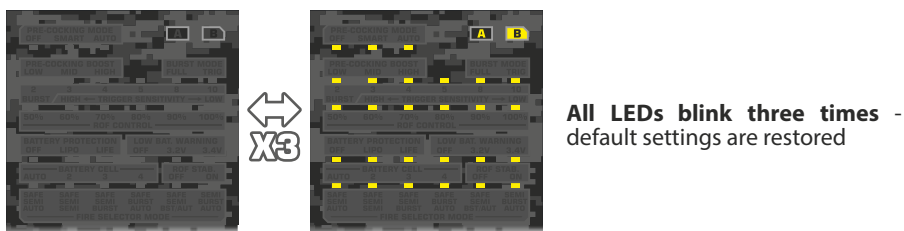
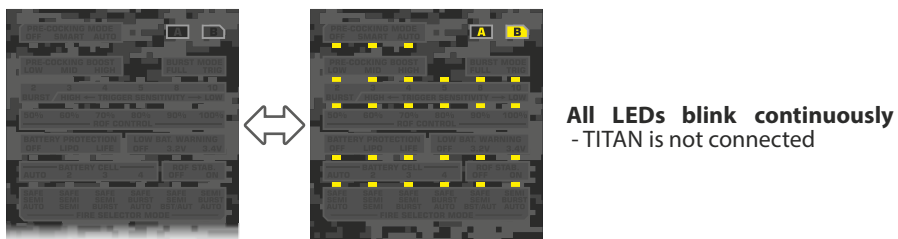

5.3 FUNCTIONS

5.3.1 FUNCTIONS (A AND B DISPLAYS OF THE TACTICAL PROGRAMMING CARD)

**PRE-COCKING MODE**

- **OFF** – PRE-COCKING is turned off. The full cycles are active.
- **SMART** – slow trigger action compresses the spring, and fast trigger action fires the shot.
- **AUTO** – the spring is automatically compressed after each shot.

IMPORTANT!

Pre-cocking mode can be switched via fire selector – you do not need to use Tactical Programming Card or USB-Link. Switch the selector to **SEMI** and pull the trigger. After firing the shot, while the trigger is still pulled, switch the selector:

1. Switch to **SAFE** → **PRE-COCKING OFF**
2. Switch to **SEMI** → **PRE-COCKING SMART**
3. Switch to **AUTO** → **PRE-COCKING AUTO**

After switching to the selected position, release the trigger. Every time you switch the PRE-COCKING using selector, your action will be confirmed by long motor vibration.

**PRE-COCKING BOOST**

It enables to determine the spring compression.

**BURST**

Enables you to fire a pre-determined number of BBs. You can set: 2, 3, 4, 5, 8 or 10 shots.

**BURST MODE**

There are two BURST operating modes:

- **FULL** – pulling the trigger results in firing a pre-determined number of BBs
- **TRIG** – releasing the trigger stops the BURST sequence

**TRIGGER SENSITIVITY**

Allows you to adjust the trigger to your preferences and level of skills.

**ROF CONTROL**

Enables a reduction in a gun's rate of fire.

**ROF STAB.**

- **ON** – ROF Control reduces the speed of the motor
- **OFF** – ROF Control adds breaks between shots to decrease ROF

**BATTERY CELL**

Enables to set the number of battery cells manually.

**BATTERY PROTECTION**

Protection against over-discharge of the battery.

**LOW BAT. WARNING**

When the battery voltage drops to the specified level (in relation to one cell), the motor will vibrate. You can set: **OFF**, **3.2V** or **3.4V** per cell.

**FIRE SELECTOR MODE**

Enables determining a firing mode for different selector positions.

5.3.2 ADVANCED FUNCTIONS

**CYCLE DETECTION**

In exceptional cases, you can turn the cycle detection off.

**30-ROUNDS LIMIT**

An AEG can continuously fire max. 30 BB's. To fire more BB's, you must release the trigger before. This is a protection against trigger jam.

Important: In case of an emergency, you can also stop firing by switching the fire selector position.

**GEAR RATIO**

To make the PRE-COCKING working with the highest level of precision you should define the gears type in your AEG. Available types: STOCK, TORQ, SPEED, DSG.

**SNIPER DELAY**

Lets you to set delay between each SEMI shots to simulate the delay from reload or recoil. You can set 0.5s, 1s, 2s or 3s delay. You can also turn on the vibration, which will inform you that you are able to fire the shot.

**AUG MODE**

Activates two stage trigger. You can set the first trigger stage with **TRIGGER SENSITIVITY** function, and the second one with **AUG MODE** function. Pulling the trigger slightly (first stage) produces SEMI or BURST fire and pulling the trigger further (second stage) produces BURST or AUTO fire (depending on the fire selector mode).

6. TROUBLESHOOTING

6.1 MOTOR VIBRATIONS

- 01 Vibrations after connecting the battery – TITAN can detect the number of battery cells automatically. If you activate this function, the vibrations will start after connecting the battery. Remember to always verify if the TITAN detected the correct number of battery cells.

VIBRATIONS AFTER CONNECTING THE BATTERY		
VIBRATIONS		EXPLANATION
1 short high frequency	↻^/\	Detection error.
2 short high frequency	↻^/\ ↻^/\	Two cells detected.
3 short high frequency	↻^/\ ↻^/\ ↻^/\	Three cells detected.
4 short high frequency	↻^/\ ↻^/\ ↻^/\ ↻^/\	Four cells detected.
4 short low frequency	↻^/\ ↻^/\ ↻^/\ ↻^/\	The trigger error. After connecting the battery TITAN detected the trigger position in which a shot may be fired.

- 02 Information vibrations – they inform you about your AEG. When the motor vibrates, you can fire a shot. The vibrations indicate the following:

INFORMATION VIBRATIONS		
VIBRATIONS		EXPLANATION
1 long low frequency	↻^/\	A change in PRE-COCKING mode by means of the selector
1 long & 1 short low frequency	↻^/\ ↻^/\	Low battery warning.
1 long & 2 short low frequency	↻^/\ ↻^/\ ↻^/\	During a shot, the selector has switched. Motor was turned off.

- 03 Alarm vibrations – they inform you that the protection was activated. The vibrations block ability to fire a shot. The next shot can be fired 1 second after vibration.

ALARM VIBRATIONS

VIBRATIONS		EXPLANATION
1 short low frequency	⚡	Too high current.
2 short low frequency	⚡ ⚡	The battery is discharged.
3 short low frequency	⚡ ⚡ ⚡	The trigger sensor error or the motor was not detected or the device temperature is too high or the selector error.

6.2 TROUBLE CODES AND WARNINGS (DTC)

UVP1

VIBRATIONS: 2X ⚡

Protection against Over-Discharge of the Battery (BATTERY PROTECTION) was activated.

POSSIBLE REASON:	WHAT TO DO:
<ol style="list-style-type: none"> 1. The battery is discharged. 2. The battery type or number of battery cells is set up incorrectly. 	<ol style="list-style-type: none"> 1. Charge the battery. 2. Check if the battery type and number of cells are setup correctly.

UVP2

Voltage dropped under 3.75V which is critical for TITAN to work properly.

POSSIBLE REASON:	WHAT TO DO:
<ol style="list-style-type: none"> 1. The battery is discharged. 2. Inadequate battery type to AEG configuration. 3. Too much electrical resistance between TITAN and the battery. 4. Motor too strong for the connected battery. 5. Motor connections short circuit. 6. Motor is jammed. 7. Motor is damaged. 	<ol style="list-style-type: none"> 1. Charge the battery. 2. Use a battery with more capacity or more voltage. 3. Do not use any adapters. 4. Use standard or high-torque motors instead of high-speed. 5. Check and fix the motor wires insulation. 6. Unjam the motor. 7. Replace the motor.

⚡ - low frequency vibration

OCP1

VIBRATIONS: 1X 

Overcurrent Protection is activated.

POSSIBLE REASON:	WHAT TO DO:
<ol style="list-style-type: none"> 1. Motor is damaged. 2. Motor is jammed. 3. Motor connections short circuit. 	<ol style="list-style-type: none"> 1. Unjam the motor. 2. Replace the motor. 3. Check and fix the motor wires insulation.

OCP2

TITAN detected current over 220A. Short-circuit protection activated.

POSSIBLE REASON:	WHAT TO DO:
<ol style="list-style-type: none"> 1. Motor connections short circuit. 2. Motor is jammed. 3. Motor is damaged. 	<ol style="list-style-type: none"> 1. Check and fix the motor wires insulation. 2. Unjam the motor. 3. Replace the motor.

OTP

TITAN temperature is too high. Over-Temperature Protection is activated.

POSSIBLE REASON:	WHAT TO DO:
<ol style="list-style-type: none"> 1. Outside temperature is too high in correlation with the demanding AEG. 2. Frequent short circuits and TITAN electrical overloads. 	<ol style="list-style-type: none"> 1. Wait until temperature will have dropped.

MOTOR DISC

TITAN didn't detect the motor.

POSSIBLE REASON:	WHAT TO DO:
<ol style="list-style-type: none"> 1. Motor is not connected. 2. Motor is damaged. 	<ol style="list-style-type: none"> 1. Connect the motor. 2. Replace the motor.

E01 - E06 GROUP

E01	Main transistor error.
E02	Break transistor error.
E03	Voltage measurement error.
E04	Temperature sensor error.
E05	Amplifier error.
E06	Other error.
POSSIBLE REASON:	WHAT TO DO:
E01 - E06 DTC indicate internal errors.	<ol style="list-style-type: none"> 1. Clear the DTC and check if the error still appears. 2. Contact GATE support team at titan@gatee.eu

E07

VIBRATIONS: 3X 

TITAN did not detect the sector gear and after 0.2s it cut off the motor.

POSSIBLE REASON:	WHAT TO DO:
<ol style="list-style-type: none"> 1. Gear sensor is damaged or is dirty. 2. Sector gear is damaged. 3. Sector gear is jammed. 4. Motor is damaged. 	<ol style="list-style-type: none"> 1. Disassemble the gearbox and check if the gear sensors are clean. 2. Carry out the sensors' inspection using the Tactical Programming Card or GCS. 3. In case of a dirty or damaged gear sensor you may set CYCLE DETECTION to OFF.

E08

VIBRATIONS: 3X 

Fire selector error.

POSSIBLE REASON:	WHAT TO DO:
<ol style="list-style-type: none"> 1. Outside light affects the fire selector sensor. 2. The selector plate is not reflecting the light. 	<ol style="list-style-type: none"> 1. Insert the gearbox into the body. 2. Modify the selector plate using the sticker from the installation kit (p. 21).

E09

VIBRATIONS: 4X 

When battery is being connected, TITAN detects a pulled trigger.

POSSIBLE REASON:	WHAT TO DO:
<ol style="list-style-type: none"> 1. Trigger is pulled while connecting the battery. 2. Trigger sensitivity is set too high. 3. Trigger sensors are dirty. 	<ol style="list-style-type: none"> 1. Release the trigger. 2. Using the Tactical Programming Card or GCS set a lower trigger sensitivity. 3. Clean the trigger sensors.

E10

VIBRATIONS: 3X 

During a shot, the selector has switched. Motor was turned off.

POSSIBLE REASON:

1. The selector was switched deliberately during a shot.
2. 2. Sensors detect switching of fire selector at the edge of selector position. During shooting, vibrations cause the fire selector to switch.

WHAT TO DO:

1. Carry out the selector sensors' inspection. If the switch takes place near to one of three selector positions (SAFE, SEMI, AUTO), you must modify the selector plate. For more information check page 25.

E11

VIBRATIONS: 1X 

Overcurrent Protection 1.

POSSIBLE REASON:

1. Motor wires' short circuit.
2. Motor is jammed.
3. Motor is damaged.

WHAT TO DO:

1. Check if the motor is jammed.
2. Check if the motor is damaged.
3. Check if there is short circuit in motor wires.

E12

VIBRATIONS: 1X 

Overcurrent Protection 2.

POSSIBLE REASON:

1. Motor wires' short circuit.
2. Motor is jammed.
3. Motor is damaged.

WHAT TO DO:

1. Check if the motor is jammed.
2. Check if the motor is damaged.
3. Check if there is short circuit in motor wires.

E13

Configuration error.

POSSIBLE REASON:

WHAT TO DO:

1. Restore factory settings.
2. Install the newest firmware.
3. Contact GATE support team at titan@gatee.eu

E14VIBRATIONS: 1X 

Internal error.

POSSIBLE REASON:

Displays when errors E01-E06 or E15 are detected.

WHAT TO DO:

Check 'WHAT DO DO' for E01-E06 or E15 and perform the same actions.

E15

Voltage measurement error 2.

POSSIBLE REASON:**WHAT TO DO:**

1. Clear the DTC and check if the error is detected again.
2. Contact GATE support team at titan@gatee.eu

NT1

Test E06 was not performed.

POSSIBLE REASON:

Information code.

WHAT TO DO:

Does not require any action.

NT2

Test E01 or E02 cannot be performed because the motor is connected to TITAN.

POSSIBLE REASON:

Information code. If you want to perform E01 or E02 test, disconnect the motor.

WHAT TO DO:

Does not require any action.

NT3

Test E15 was not performed.

POSSIBLE REASON:

Information code.

WHAT TO DO:

Does not require any action.

6.3 FREQUENT PROBLEMS

MALFUNCTION	POSSIBLE REASON	WHAT TO DO
After connecting the battery to AEG, the AEG does not fire. No vibrations.	<ul style="list-style-type: none"> • No connection with battery • The selector is switched to SAFE • Error during firmware update • The motor is not connected • Negative result of the built-in self-test 	<ul style="list-style-type: none"> • Read the DTC • Clean the battery connector • Clean the TITAN deans-t connector • Check if the wires are damaged • Switch the selector to SEMI or AUTO • Check the motor connection
After connecting the USB-Link to PC, it is not recognized by GATE Control StationApp.	<ul style="list-style-type: none"> • The computer USB port does not work • The device's drivers are not installed • There is hardware conflict with other devices connected to PC 	<ul style="list-style-type: none"> • Install the driver (see point 3.2) • Connect the USB-Link to another USB port • Disconnect other devices from USB ports
After connecting the programming card to TITAN, display's LED indicators turn on and off every one second.	<ul style="list-style-type: none"> • No connection between the programming card and TITAN • Incompatible firmware 	<ul style="list-style-type: none"> • Check if the wires are damaged • Disconnect and reconnect the TITAN • Update the programming card's firmware • Update the TITAN's firmware
The lines of LED indicators on the programming card turn on and off one by one.	<ul style="list-style-type: none"> • The programming card's internal error 	<ul style="list-style-type: none"> • Update the firmware of the programming card
AEG stops firing suddenly.	<ul style="list-style-type: none"> • The internal protection was activated • The battery is discharged 	<ul style="list-style-type: none"> • Read the DTC • Wait a few seconds and try again

In case you have any difficulties while using this product, we recommend to email us at titan@gate.eu.

7. WARRANTY POLICY AND LEGAL ASPECTS

IMPORTANT INFORMATION Please read this information before operating your device. This section contains important terms and conditions with respect to your device. By using this device, you accept those terms and conditions.

EXCLUSION OF LIABILITY GATE Menet, Wojtak Sp. J. is not liable for any damages, injuries or accidents of any kind resulting from the use of this product or airsoft gun with the product installed, including (but not limited to) incidental or special damages to airsoft gun, airsoft gun parts, batteries and gearbox internals.

DISCLAIMER GATE Menet, Wojtak Sp. J. takes no responsibility regarding compliance of the product with the requirements of any law, rule or airsoft restrictions pertaining thereto. **INTELLECTUAL PROPERTY** Intellectual Property owned by GATE, including but not limited to, devices, accessories, parts, software, documentation, is proprietary to GATE and protected under Polish laws, EU laws, and international treaty provisions. You may not violate the rights of the Intellectual Property and you will not prepare derivative works of or reverse engineer the device or software. No ownership in the Intellectual Property is transferred to you.

GATE LIMITED WARRANTY POLICY GATE Menet, Wojtak Sp. J. warrants that its Product is free from manufacturing and material defects at the date of purchase and for a period of one (1) year from the date of purchase and it is not-extendable. This Limited Warranty is conditioned upon proper use of Product by Purchaser.

1. This Limited Warranty is valid provided that the owner provides a proof of purchase and properly completed warranty form.
2. This Limited Warranty does not cover: (a) defects or damage (eg. mechanical, thermal or chemical) resulting from accident, misuse (misinterpretation of the instructions), abuse, neglect, unusual physical, electrical or electromechanical stress, water immersion, repairs or structural modification of any part of Product, or (b) the Product that has the serial number removed or made illegible; (c) defects or damage from improper operation, maintenance or installation, (d) installation of the products.

3. Requests for warranty are processed as soon as possible, not exceeding seven (7) working days. The company's obligation under this Limited Warranty shall be limited to providing replacement of part/s only.

PRODUCT DISPOSAL INSTRUCTIONS



The symbol shown here means that the product is classed as Electrical or Electronic Equipment and should not be disposed with other household and commercial waste at the end of its working life. The Waste of Electrical and Electronic Equipment (WEEE Directive 2012/19/EU) has been put in place to recycle products using best available recovery and recycling techniques to minimize the impact on the environment. Purchasers shall take any old electrical equipment to waste recycling public centers or points of sale.



CERTIFICATE OF CONFORMITY



GATE Menet, Wojtak Sp. J. hereby declares under our sole responsibility that the product TITAN is in conformity with the essential requirements of the following Directives:
 EC DIRECTIVE 2011/65/EU
 This product has been certified as RoHS Compliant.