



# THE FUTURE OF HUNTING



**RS3**

Short - Safe - Silent

# HUNTING OF TOMORROW WILL FUNDAMENTALLY CHANGE FIREARMS DESIGN.

## WALTHER LEADS THE WAY WITH THE RS 3.

### Hunting with silencers

Hunting with silencers has become an increasingly essential part of modern hunting to optimise ethical, efficient and successful hunting. A silencer not only protects a hunter's hearing, but it also significantly reduces disturbance for game and the natural environment. A hunter shoots more accurately and with higher confidence because recoil and muzzle blast are minimised, making shooting significantly more comfortable.

### The wrong path: shortening a barrel to fit a silencer

The problem to solve is how to integrate a silencer as a core function of a rifle to maintain optimal barrel length, balance and ergonomics. Traditional bolt-action and even modern compact straight-pull rifles are unable to do this. Many manufacturers try to overcome this by dramatically shortening the barrel length and forward mounting a silencer. Performance suffers. If a .300 Winchester Magnum barrel is shortened from 62 cm to 42 cm, the .300 Win Mag. is effectively reduced to a .308 Winchester. Even after reducing barrel length, adding a silencer still results in an extremely long, unbalanced and heavily front-weighted rifle.

The 'pointability' and handling, so critical for driven hunts, are completely lost. In addition, with a drastically shortened barrel, lead distance on running game increases dramatically and long-range performance is significantly reduced.

### Time to reinvent the bolt-action rifle

The first truly compact straight-pull rifle with a silencer perfectly matched and balanced to the overall system. Integrated and designed ground up. The focus can therefore remain on target without any sacrifice in performance or ergonomics.

### The result:

- Outstanding handling on driven hunts, during stalking and in a high seat.
- Optimal barrel length for the ballistic performance of each calibre.
- Ideal balance, ergonomics and outstanding pointability. The RS 3 is highly intuitive and naturally points where the hunter's eye is focused.
- All functional elements are ergonomically positioned for lightning-fast cocking and bolt cycling.

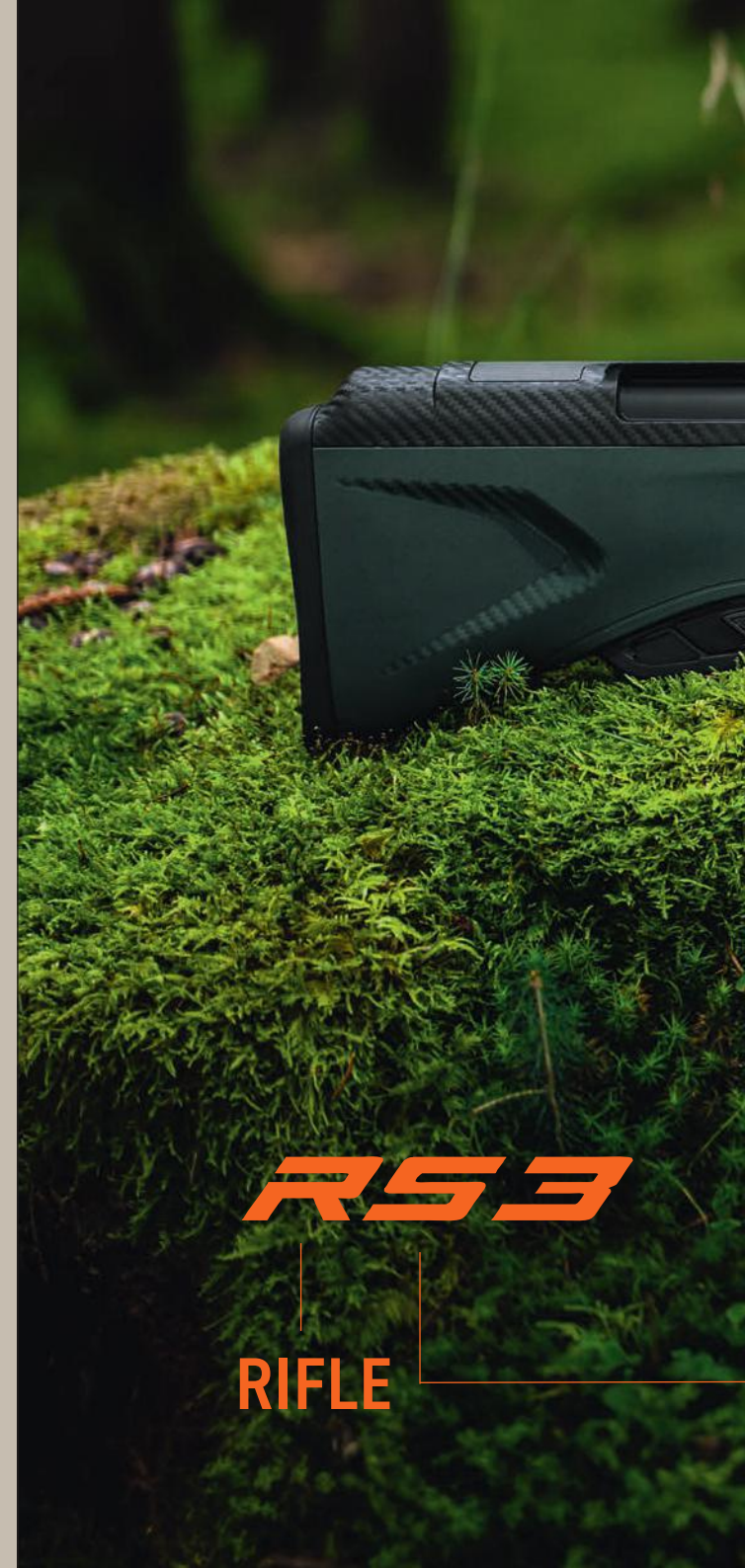

**RS3**

**RIFLE**

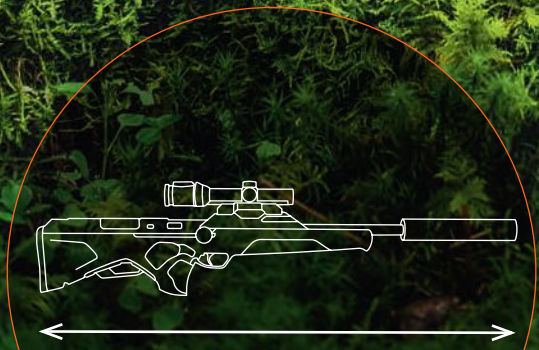

**SHORT**



**SAFE**



**SILENT**

»DESIGNED FOR INTUITIVE SHOOTING.  
THE RS 3 AIMS WHERE I LOOK,  
SHOOTS WHERE I AIM  
AND CYCLES AS FAST AS I THINK.«

Franz-Albrecht zu Oettingen-Spielberg



WINDSTOPPER

HARSTIA

**FRONT-HEAVY WITH A SILENCER?  
SHOULD THE BARREL BE SHORTENED?  
- THE CHOICE BETWEEN TWO EQUALLY POOR OPTIONS -  
  
THE RS 3 IS THE COMPROMISE-FREE SOLUTION.**

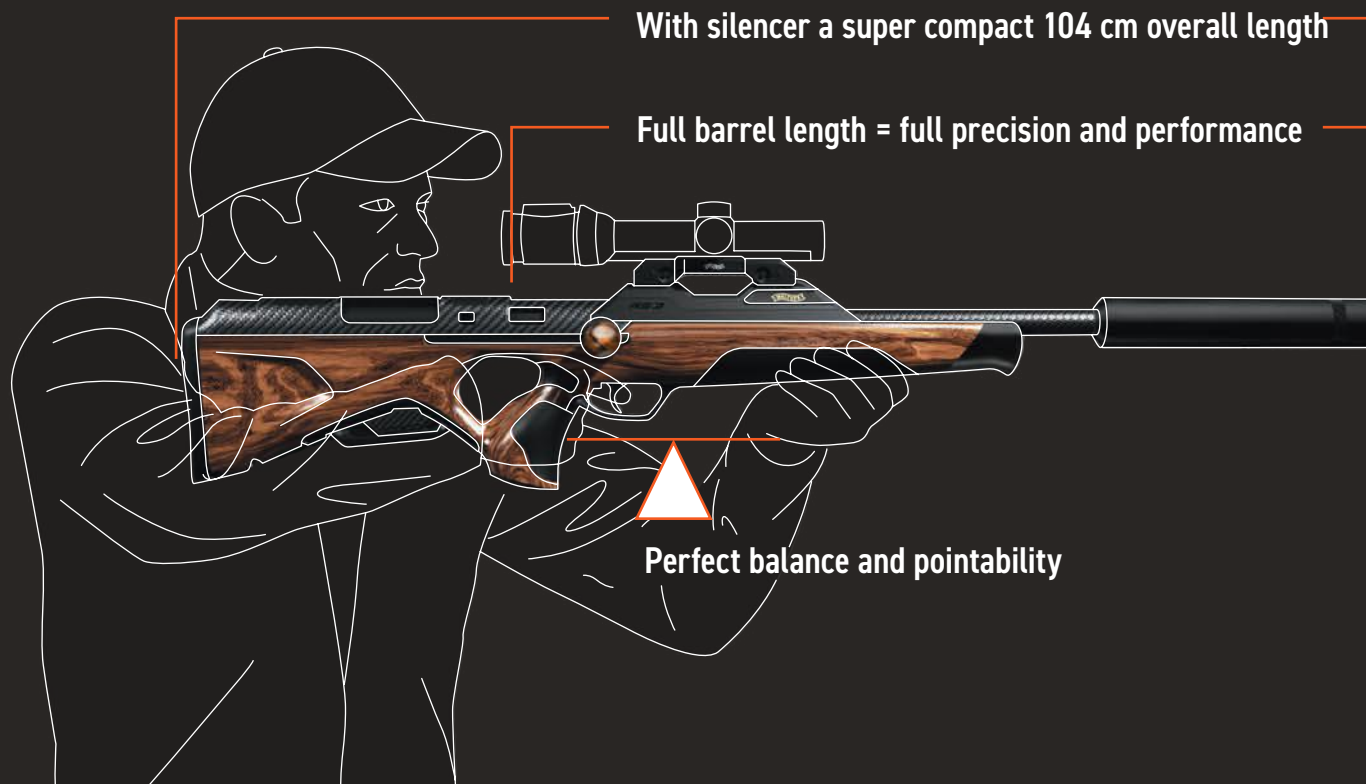

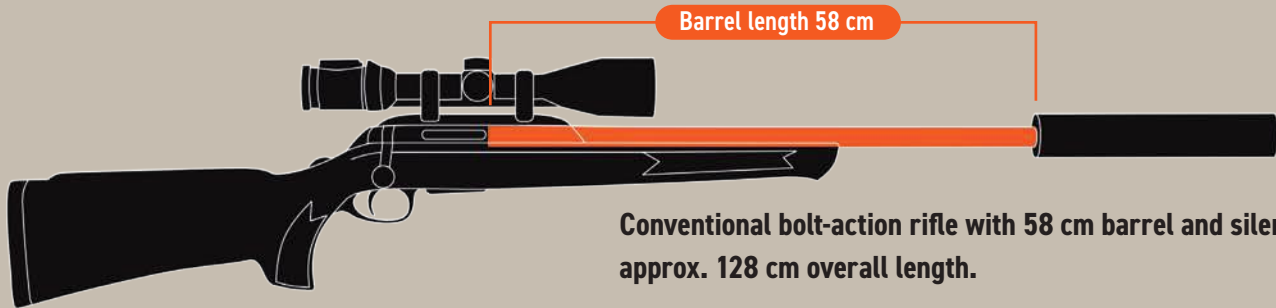

Conventional bolt-action rifle with 58 cm barrel and silencer approx. 128 cm overall length.

- ⚠ Front-heavy
- ⚠ Long and unwieldy

## WHY "CUTTING THE BARREL" IS NOT THE SOLUTION

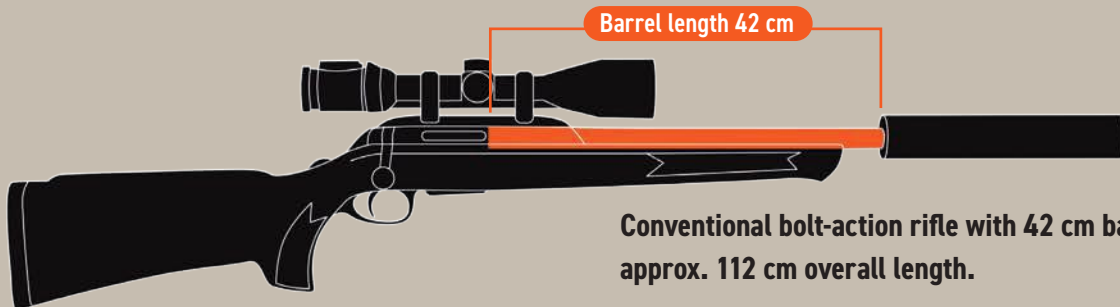

Conventional bolt-action rifle with 42 cm barrel and silencer approx. 112 cm overall length.

- ⚠ Altered internal ballistics
- ⚠ Loss of performance
- ⚠ Loss of precision
- ⚠ Increased lead distance

REDUCING BARREL LENGTH: NO. SAVE OVERALL LENGTH: YES.  
A REDUCTION WHERE IT MATTERS.

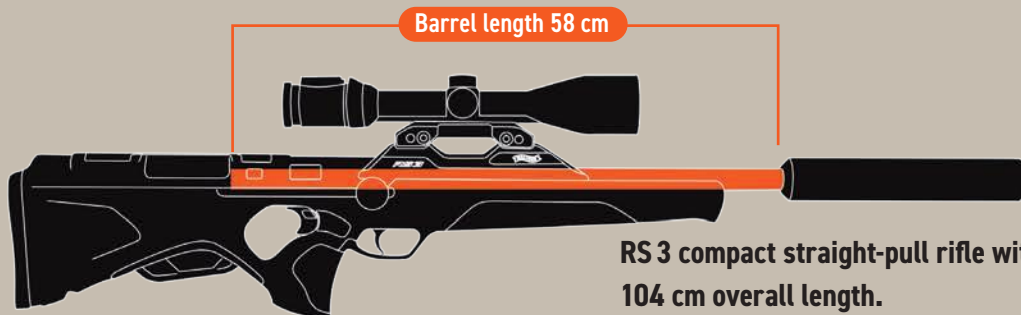

RS3 compact straight-pull rifle with 58 cm barrel and silencer 104 cm overall length.

**RS3**

- ✓ Full barrel length
- ✓ Full precision
- ✓ Compact and pointable
- ✓ Perfect internal ballistics
- ✓ Full performance

# HUNTING FEVER?



# THE RS 3 IS COMPACT WITHOUT COMPROMISE.

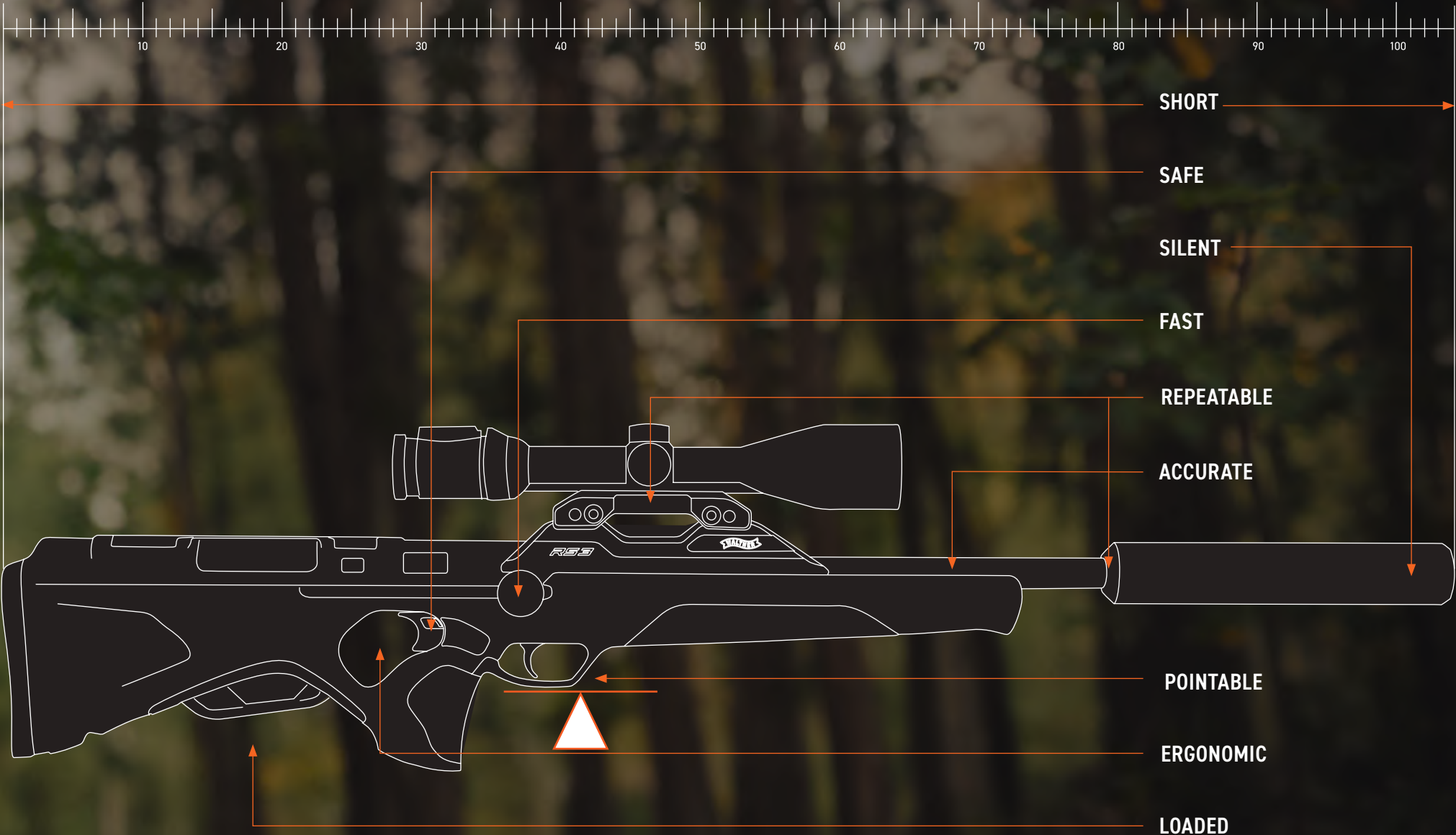

REACHING TO COCK OR DECOCK?  
FOCUS AND TIME ARE LOST.

**WITH THE RS 3, COCKING IS  
IN YOUR HAND.**

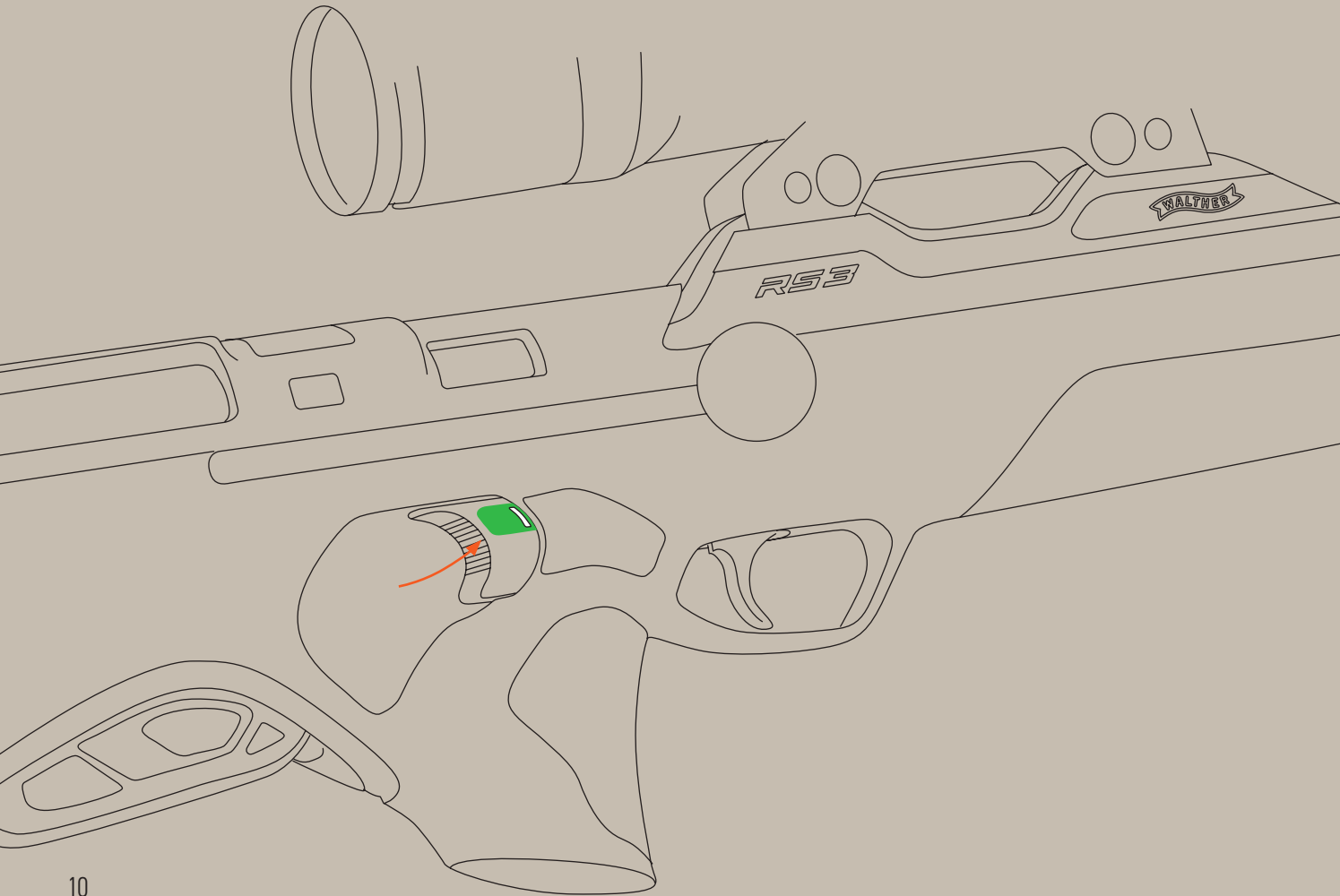

# ULTIMATE SAFETY IN YOUR HAND.

## Safe: Hand-cocking in the pistol grip

The unique hand-cocking system of the RS3 is integrated into the pistol grip of the thumbhole stock. The rifle is cocked intuitively when mounting the rifle or when in a shooting position. The safety state of the rifle is felt by hand in all conditions, even in cold weather, with gloves or in darkness. Target acquisition, mounting and cocking merge into one fluid movement.

Bright signal colours clearly indicate the cocking state at all times for the benefit of you and those around you. To open the bolt, a light tap on the cocking slide is sufficient, all while remaining in a safe condition.



**FAST AND TO THE POINT.**

**ONE POSITION. ONE MOTION.  
ALWAYS THE SAME POINT OF IMPACT.**

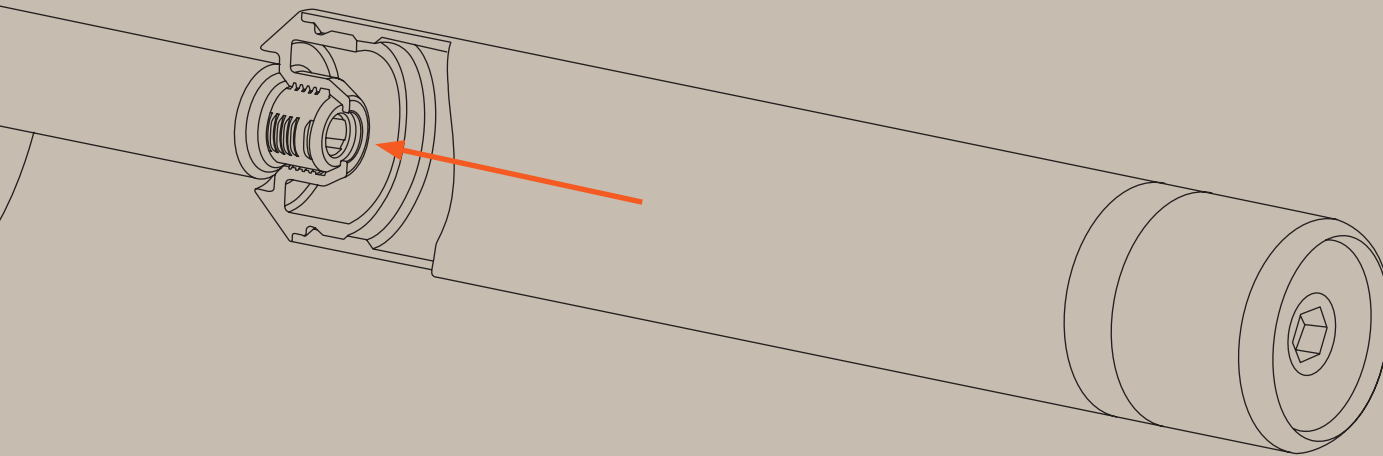

# ZEROLOCK QUICK ATTACHMENT.



Quiet: *QSA* silencer  
with ZeroLock quick attachment

The RS 3 is supplied as standard with a Walther QSA silencer featuring ZeroLock quick attachment. Standard configuration includes the Walther QSA hunting silencer made from tenifer-nitrided steel and a high strength anodised aluminium tube. The patented ZeroLock system allows for mounting in one position with only a short 60° turn to mount, ensuring a constant point of impact even after removal and reattachment. The separate Walther heat protection sleeve allows rapid removal and immediate stowage of the silencer, even when hot.

MECHANICS UNLOCKING ACCURACY.

**WALTHER PERFORMANCE TRIGGER.**

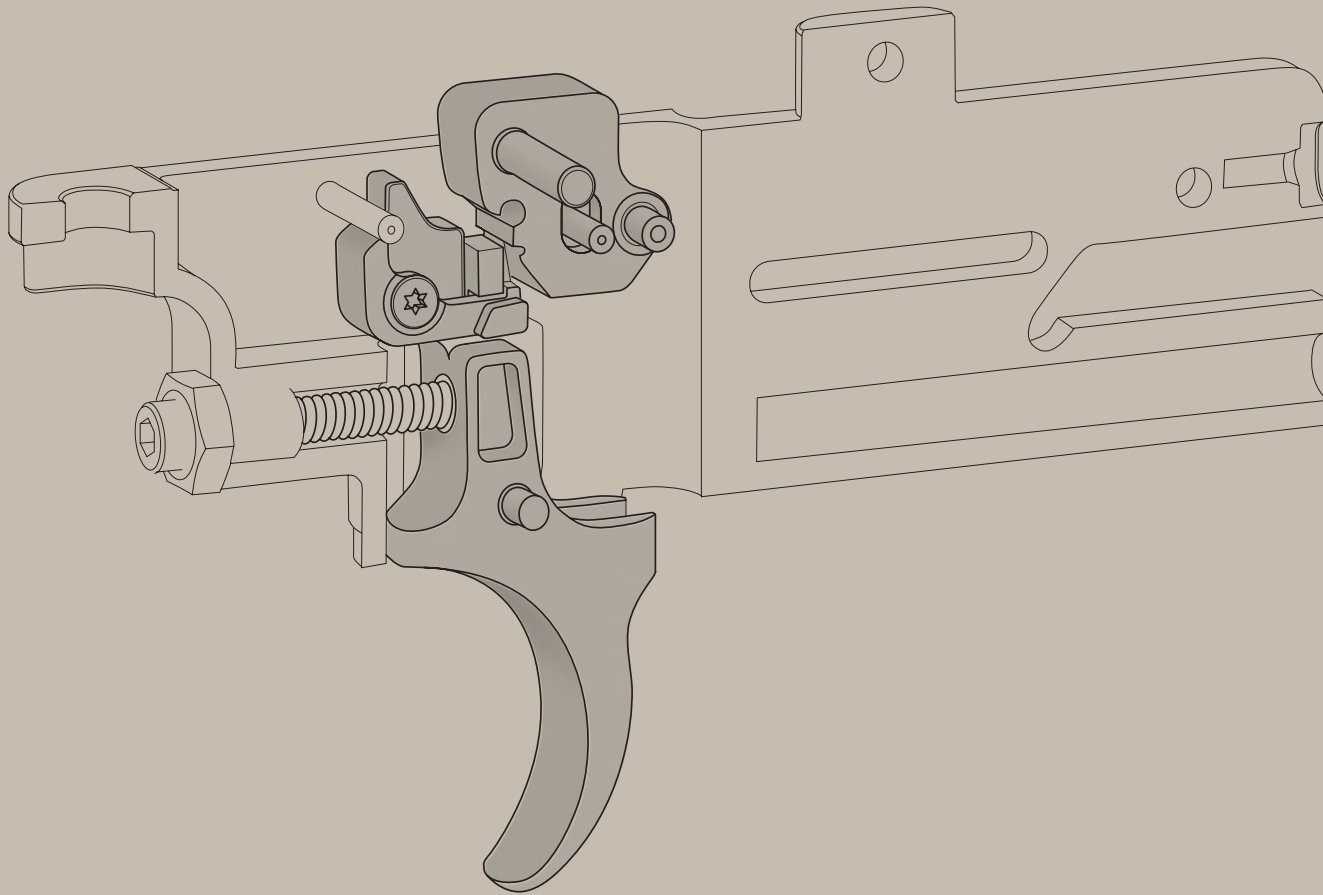



**FEEL THE SHOT BREAK.**

**Precise: Walther Performance Trigger**

Walther is world-renowned for its triggers. For decades, we have developed triggers for Olympic champions, police forces and military units. All of this expertise has been incorporated into the Walther Performance Trigger. It breaks at 800 grams like glass. Light enough for ultimate accuracy. Heavy enough to prevent unintentional discharge under stress on driven hunts or when wearing gloves.

**FOCUS ON WHAT MATTERS.**

**CYCLE IN THE SHOULDER.  
KEEP YOUR EYES ON TARGET.  
RAPID FOLLOW UP SHOTS.  
SHOOT AS FAST AS YOU THINK.**

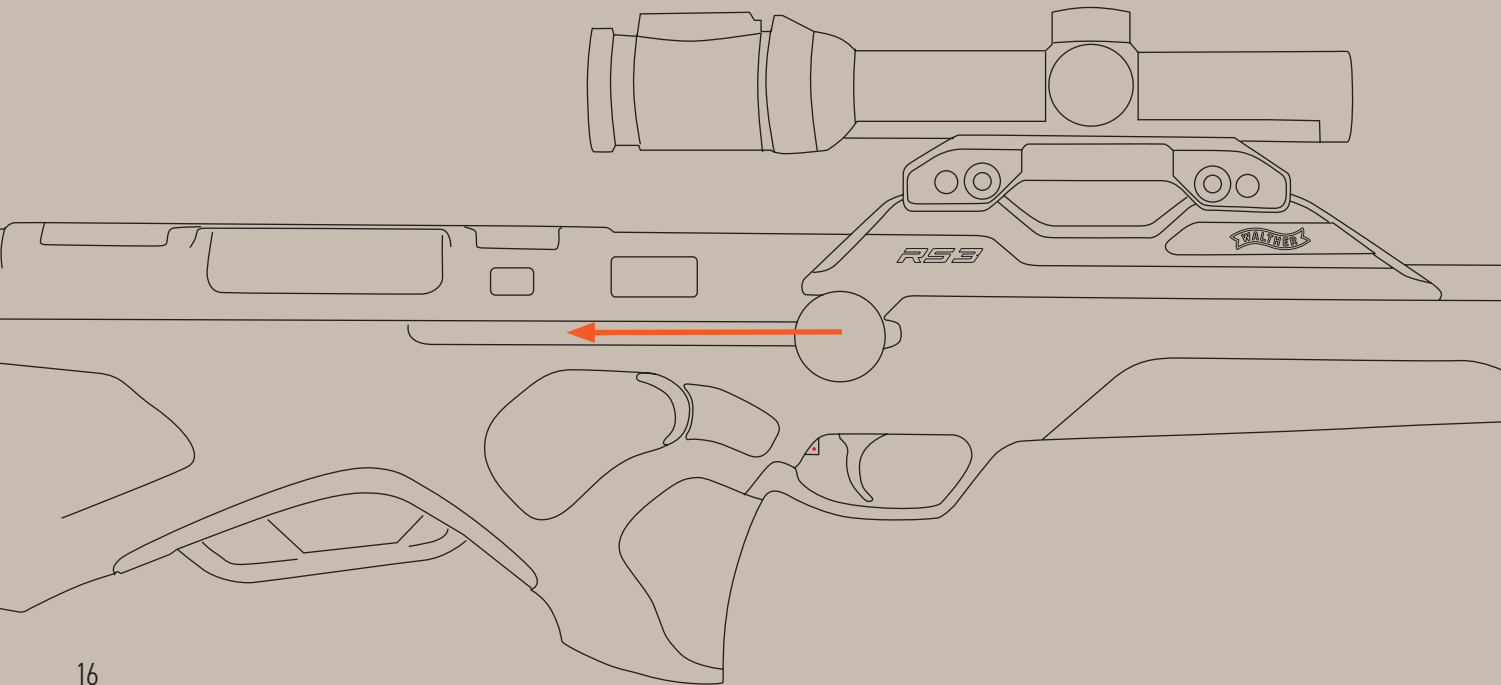

# STRAIGHT. FAST. FOCUSED.

## The Walther straight-pull action

The straight-pull system operates linearly and is simple and intuitive to use. The bolt handle is perfectly positioned and generously dimensioned. Even after firing, there is no need to lift your head, the RS 3 allows you to remain fully focused. Cycling is performed in the shoulder so your eyes can stay on target enabling fast, precise follow-up shots. The rifle recocks during cycling and is immediately ready to fire again.

BETTER TO HAVE THAN TO NEED.

**IT'S REASSURING TO BE  
WELL BACKED UP.**

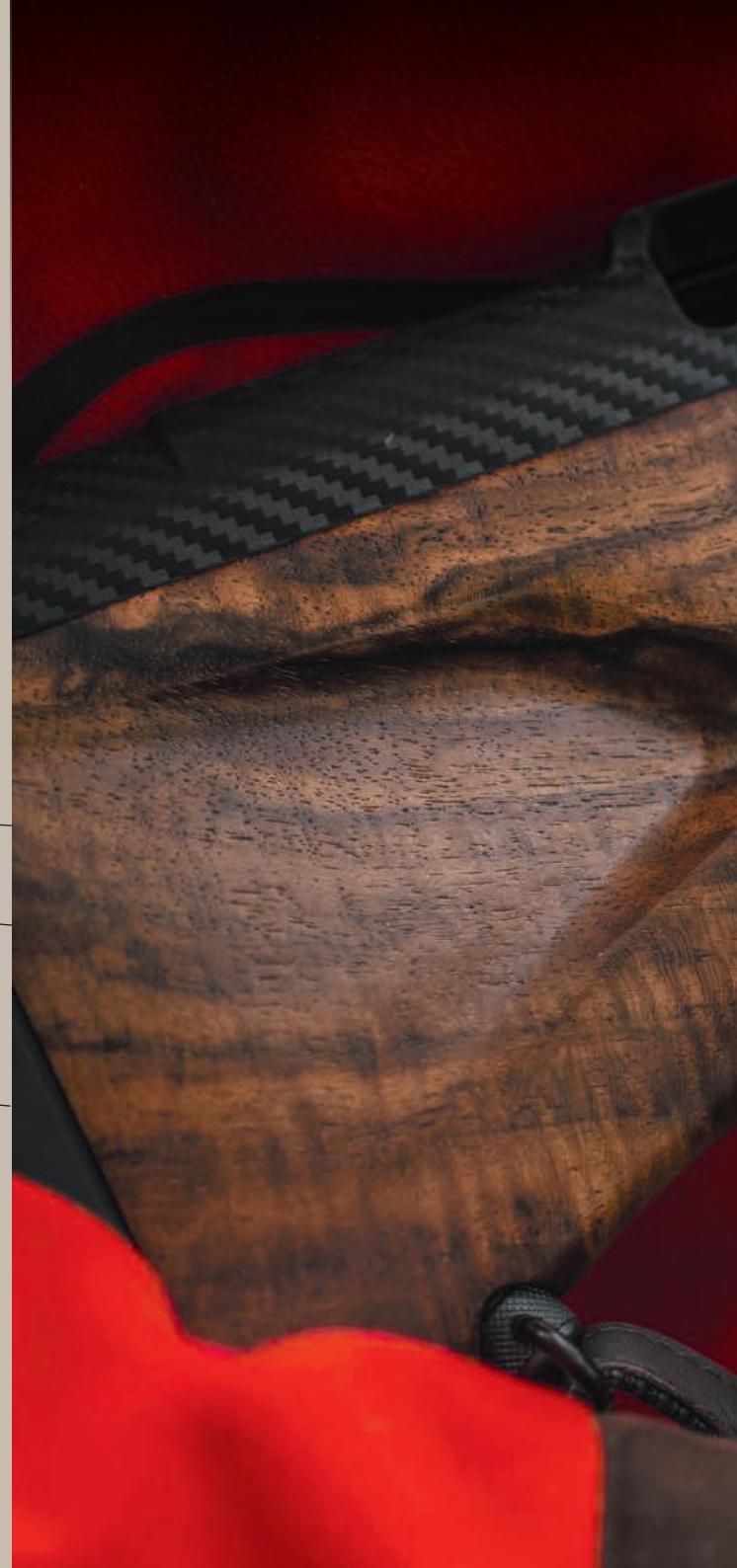
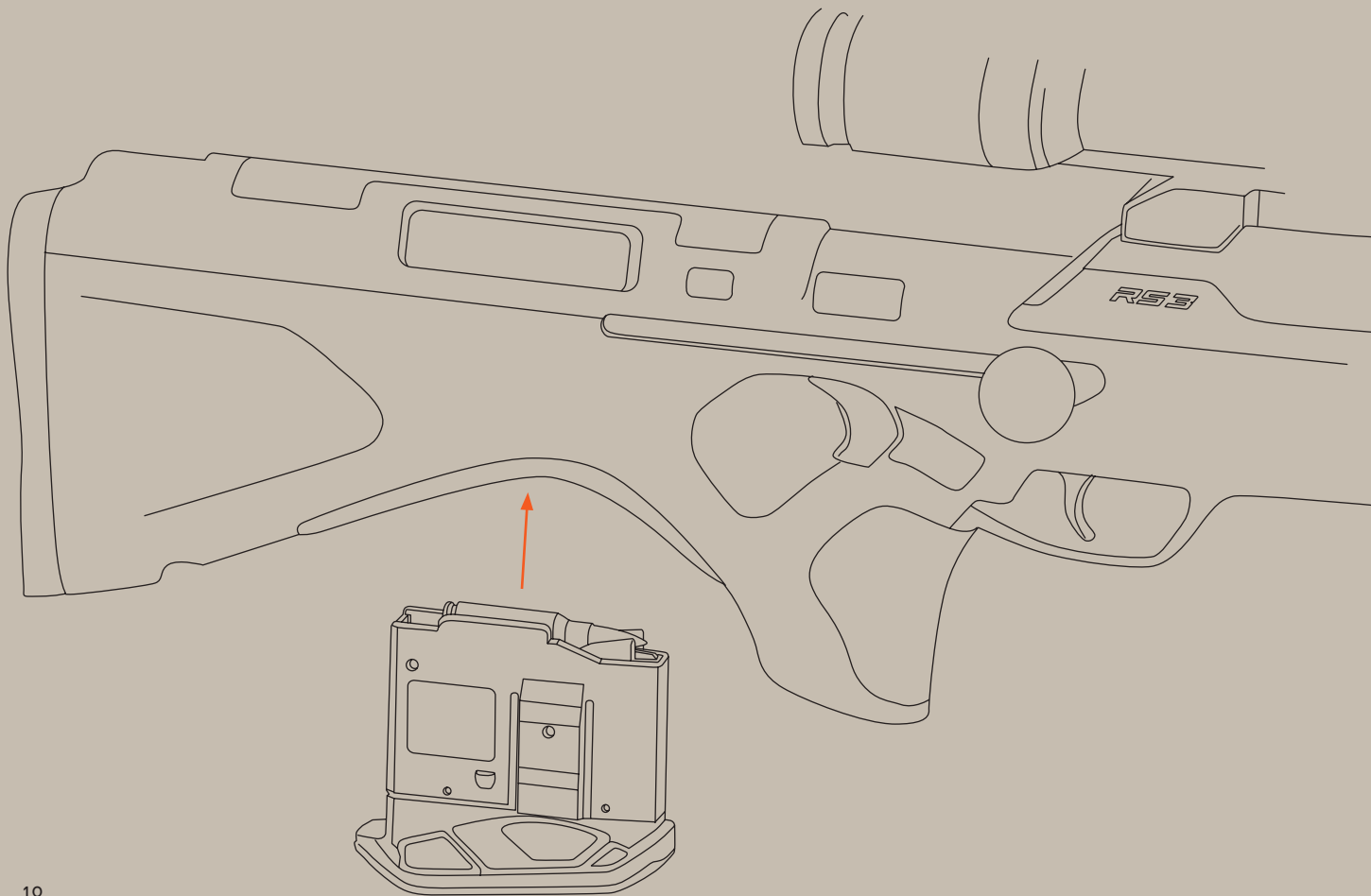

**6 + 1. IN LINE.**

### Walther single-stack magazine

The RS 3 features a reliable polymer single-stack magazine with a capacity of 6 rounds (+1) in standard calibres. In magnum calibres, 5 rounds (+1).

The magazine is conveniently positioned behind the pistol grip for quick loading.

Two secure locking tabs must be pressed simultaneously which prevents accidental magazine release.

F1 MOTORSPORT TECHNOLOGY.

**THE WALTHER MONOCOQUE  
IS THE CORE OF THE RS 3.**

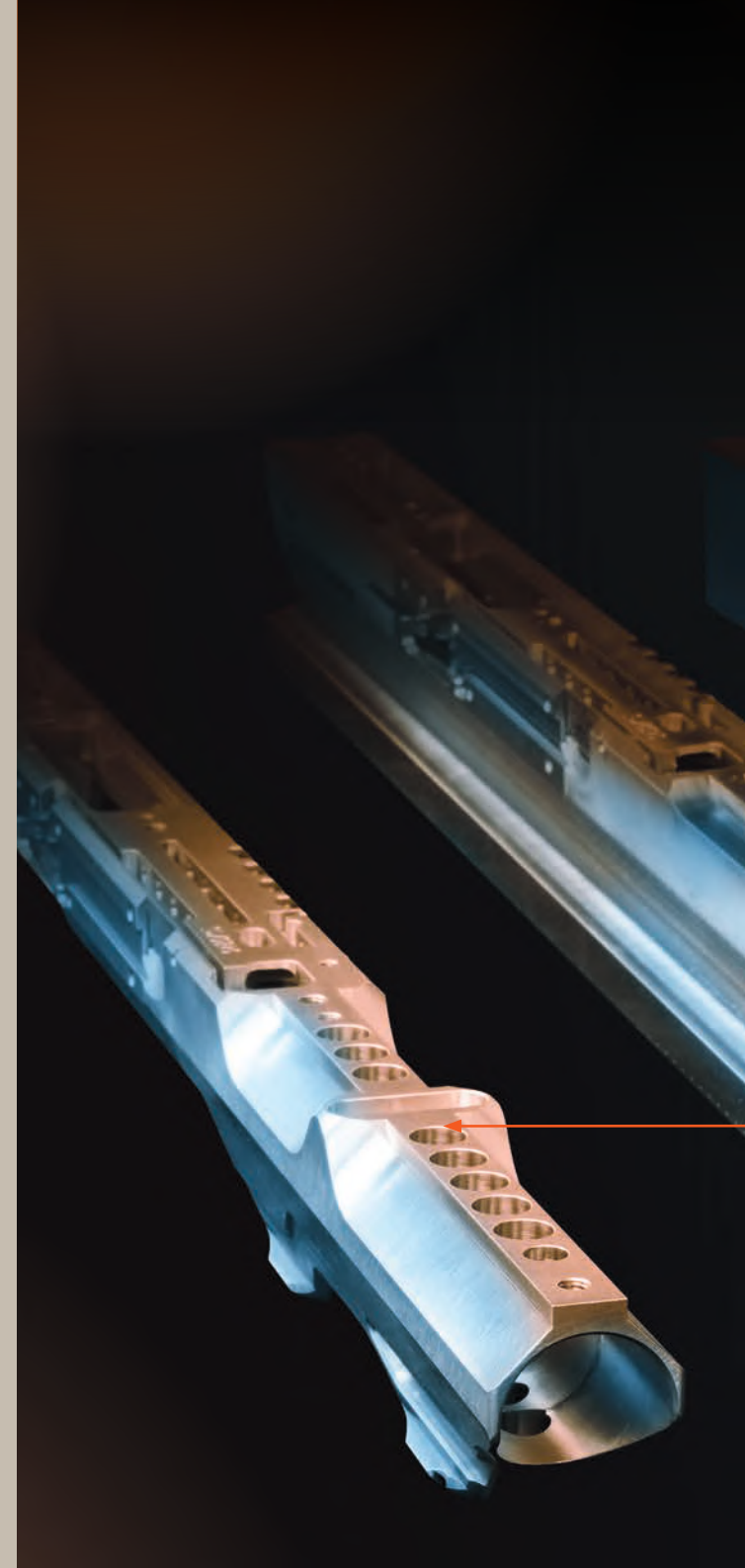
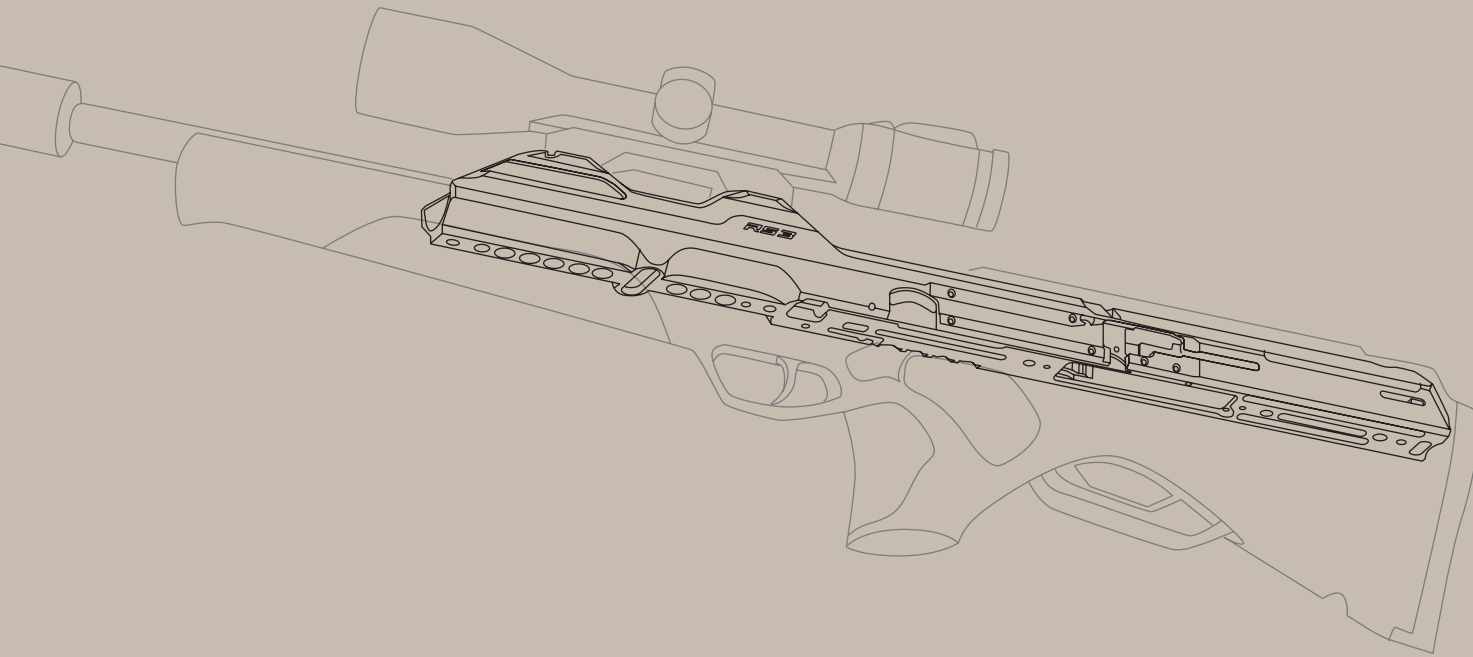



**MACHINED FROM SOLID ALUMINIUM.**

### **The Walther RS 3 Monocoque**

The heart of the RS 3 is a 64 cm long single-frame aluminium system housing based on the monocoque principle of Formula 1 for maximum rigidity, maximum safety, minimal tolerances and absolute weight optimisation – resulting in genuine sub-MOA precision. All moving parts are completely protected inside of this ultra-robust cage.

THE STOCK IS NOT THE SOLE SOURCE  
OF SUCCESS.

**THE COMPOSITION OF OVERALL-LENGTH,  
BALANCE AND IDEAL STOCK  
CREATES THE PERFECT SYMPHONY.**



A man wearing a red cap and a red jacket is aiming a rifle. The rifle has a scope and a suppressor. The background is a blurred natural setting.

# A RIFLE THAT FITS LIKE A GLOVE.

## "Pointability": Natural aiming behaviour

The weight of the RS3 has been designed to sit precisely between the hands, with the centre of gravity at the trigger guard. The result of ultra-compact length, perfect balance and optimal weight distribution is intuitively pointable, clearly distinguishing the RS3 from other rifles.

**MOUNT. LOCK.**

**TOOL-FREE. ONE-HANDED.  
100% PRECISE.**

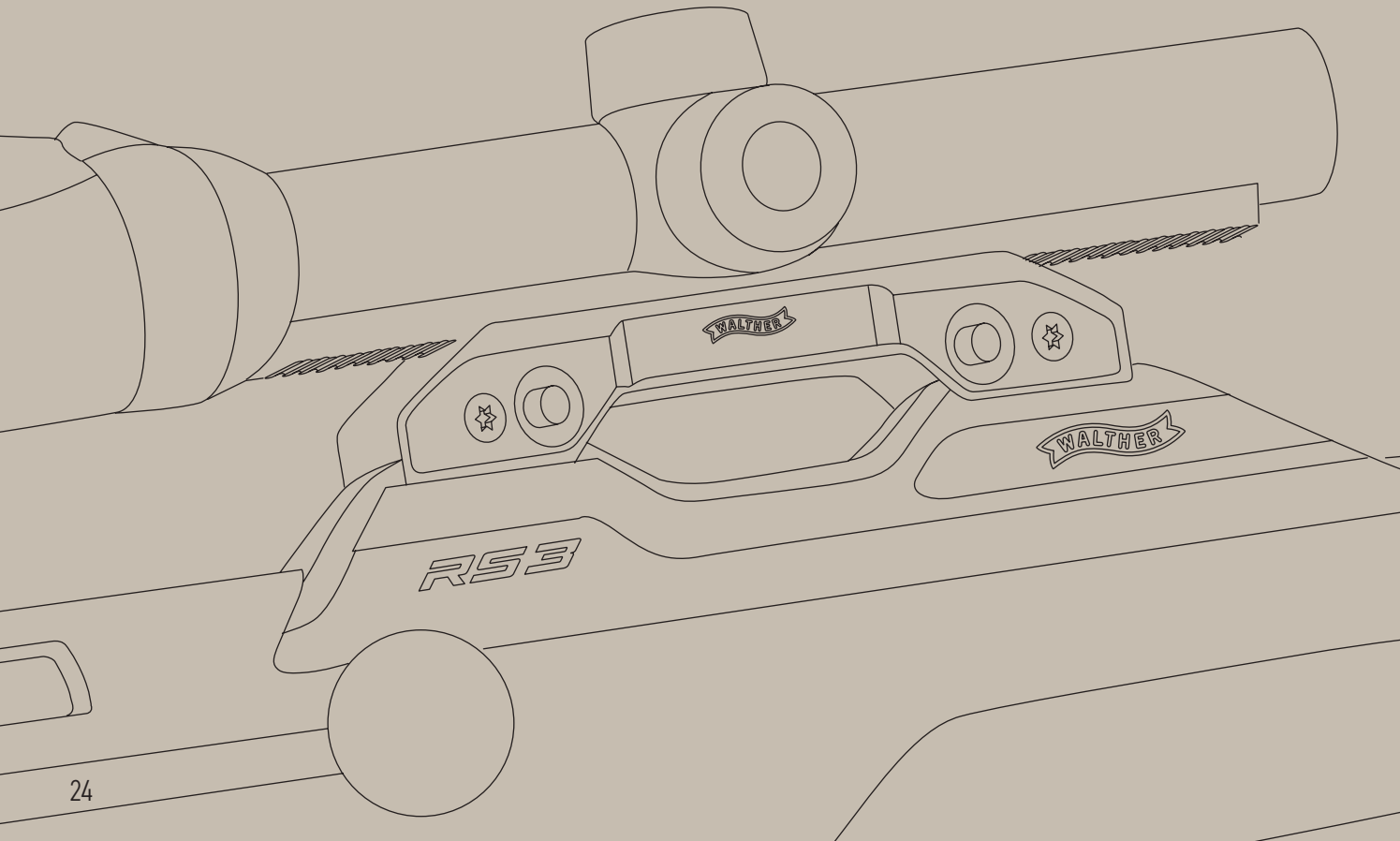

### ***FIXLOCK*** Mounting System

Walther FIXLOCK mounts are designed for all common optics. Thanks to the patented pressure-piece system, they are robust and absolutely return to zero time and time again. The mounting bases have also been optimized for optics of the future and provide maximum stability, particularly for clip-on devices with specific weight and leverage demands under recoil and the toughest conditions. This system is reliable and simple to operate.

# WALTHER FIXLOCK MOUNTING SYSTEM.



# READY FOR ANYTHING.

## FIXLOCK: AS VERSATILE AS THE WORLD OF OPTICS.

### Fixlock bases for Zeiss- or Swarovski riflescopes with an internal rail.

The perfect mechanical connection between rifle scope and mount. Removable at any time, allowing eye relief to be adjusted as required.

### Fixlock base for ring-mounted riflescopes without a rail.

### Fixlock base with adapter plate for red dot sights.

This is a completely modular system designed for simplicity by Walther. For driven hunt enthusiasts or dog handlers.

### Fixlock base with Picatinny profile.

The mount for individualists. Maximum adaptability thanks to the Picatinny standard.

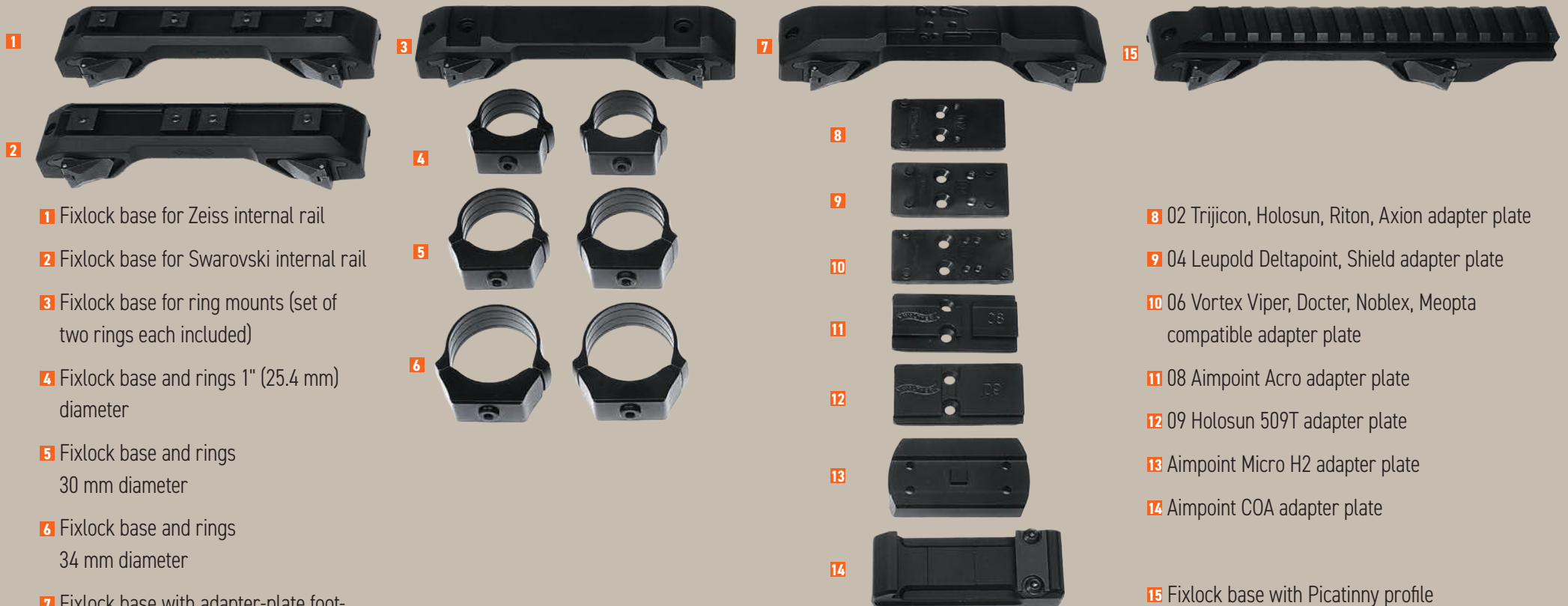

1 Fixlock base for Zeiss internal rail

2 Fixlock base for Swarovski internal rail

3 Fixlock base for ring mounts (set of two rings each included)

4 Fixlock base and rings 1" (25.4 mm) diameter

5 Fixlock base and rings 30 mm diameter

6 Fixlock base and rings 34 mm diameter

7 Fixlock base with adapter-plate footprint for red dot sights

8 02 Trijicon, Holosun, Riton, Axion adapter plate

9 04 Leupold Deltapoint, Shield adapter plate

10 06 Vortex Viper, Docter, Noblex, Meopta compatible adapter plate

11 08 Aimpoint Acro adapter plate

12 09 Holosun 509T adapter plate

13 Aimpoint Micro H2 adapter plate

14 Aimpoint COA adapter plate

15 Fixlock base with Picatinny profile



Clip-on hunting optics



Ring mount



Walther's smart solution for maximum flexibility!

A single Fixlock mount for red dots allows almost any red dot sight on the market to be installed via adapter plates.

Technical data Walther RS 3			
Available calibres*	.308 Winchester	.30-06 Springfield	.300 Win. Mag.
Overall length	104 cm / 41"	104 cm / 41"	108 cm / 42.5"
Barrel length	58 cm / 22.8"	58 cm / 22.8"	62 cm / 24.4"
Weight incl. silencer	3,8 kg / 8.4 lbs	3,8 kg / 8.4 lbs	3,9 kg / 8.6 lbs
Weight without silencer	3,5 kg / 7.7 lbs	3,5 kg / 7.7 lbs	3,6 kg / 7.9 lbs
Weight silencer	350 g / 13.3 oz		
Magazine capacity	6 rounds	6 rounds	5 rounds

\*Additional calibres are being developed

WHY ADD A MUZZLE BRAKE AS WELL?

WALTHER HAS DESIGNED A CONCEPT  
THROUGH TO THE END.

**THE MUZZLE BRAKE IS THE SOLUTION FOR  
COUNTRIES WHERE SILENCERS ARE NOT  
PERMITTED OR WHEN A HUNTING TRIP  
TAKES YOU THERE.**

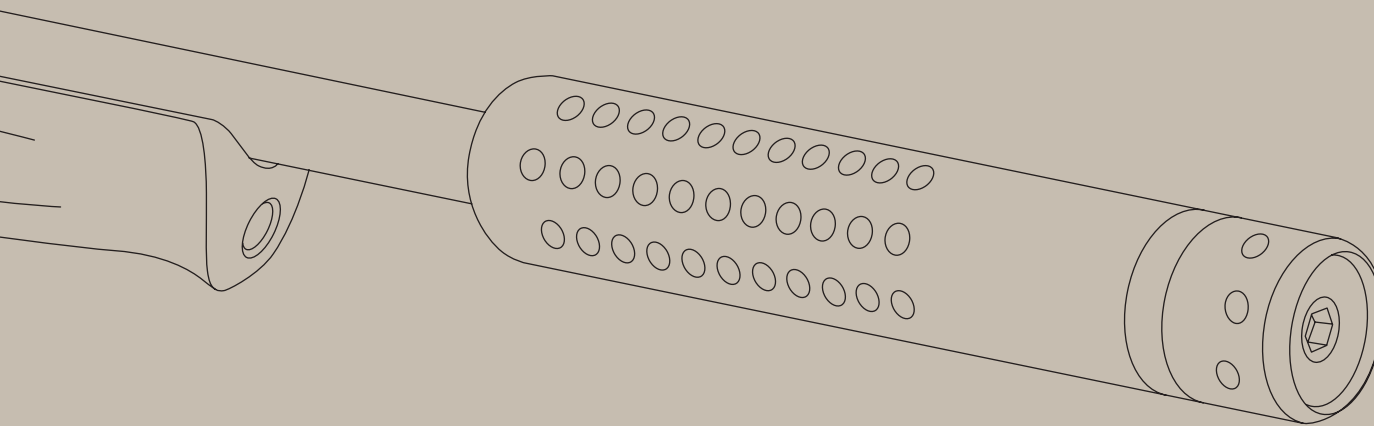



Walther QCA muzzle brake **QCA**

Balanced in the same way as the silencer for perfect pointability. Originally developed for countries where silencers are not permitted, the QCA with Zerolock quick attachment reduces recoil by an impressive 40 %. This was reason enough to make it universally available. The RS 3 sits rock-solid under recoil. BUT: do not forget hearing protection, muzzle blast is not reduced with the QCA muzzle brake.

# WOOD OR SYNTHETIC STOCK?



# PURELY A MATTER OF TASTE AND APPLICATION.

**RS 3 Heritage Sevenstar** with Caucasian walnut stock, grade 7, and black elastomer grip inlays.



**RS 3 Heritage Fourstar** with Caucasian walnut stock, grade 4, and black elastomer grip inlays.



**RS 3 Pro Pine** with dark green synthetic stock and black elastomer grip inlays. Additional bipod interface on the forend.



**RS 3 Pro Chestnut** with dark brown synthetic stock and black elastomer grip inlays. Additional bipod interface on the forend.



**THREE STYLES, ONE RS 3.  
MORE FREEDOM FOR DRIVEN HUNTS, STALKING  
OR SITTING IN A HIGH SEAT.**



# RS 3 PRO CHESTNUT



## RS 3 with synthetic stock

Those who head into the field or on active hunting trips appreciate not having to worry about a precious wooden stock. In cold and wet conditions, the stock remains grippy and warp-free and easily withstands the occasional knock.

## RS 3 PRO PINE



### **Agile and compact for every hunting application**

Wherever your passion takes you, the RS 3's compact design always gives it the advantage, whether climbing into a high seat, mounting quickly, or moving through rough terrain. It can be comfortably carried in a backpack and is the perfect companion for stalking on difficult ground. With a Walther bipod or modern shooting stick, the RS 3 delivers its full potential. No hunting ground will limit the RS 3.



Every RS 3 Pro variant features a magnetic mounting point with a protective cover for the Walther bipod or a compatible shooting stick system.



## RS 3 HERITAGE WITH WALNUT STOCK.



### **RS 3 Heritage Walnut stock. Elegance at the highest grades of wood excellence.**

Caucasian walnut root burl embodies traditional values and a refined appearance. The satin-matte finish protects the fine wood from moisture and dirt. Ebony accents on the pistol grip and the finely shaped forend give the rifle a confident elegance in harmony with the carbon surfaces. The RS 3 becomes a reflection of its owner's personality. Walther's Meister Manufaktur team of artisans can deliver customisation from fine engraving, premium wood upgrades, leather inlays or monograms.

# AS WELL DESIGNED AS THE RS 3: PREMIUM ACCESSORIES FOR ALL TYPES OF SHOOTING AND HUNTING.

**Stylish from the muzzle to butt pad: Walther offers a range of practical accessories for the RS 3.**

## **1 RS 3 Rifle Sling**

The best of all worlds. Non-slip neoprene with leather and an elegant outer durable fabric in Walther pebble grey:

- Corrosion-protected sling swivels. One click and the sling is securely attached. A press of a button is enough to remove it on the high seat or shooting range,
- Cartridge loops for two spare cartridges,
- The sling offers a sufficient stretch even for the toughest stalks,
- Noise-reduced polymer buckles that prevent scratches on the rifle,
- Adjustable to 119 cm.

## **2 Walther Silencer Protection Cover**

Thanks to its neoprene inlay, the cover sits securely on the silencer and reliably protects against impacts and noise in the field and high seat.

- Neoprene inlay for a non-slip fit,
- Wide Velcro strip on the underside with leather reinforcement for secure fixation along the full length.

## **3 Walther RS 3 Rifle Bag**

Walther RS 3 bag for rifle and accessories. Protected and secure wherever you go. The Walther bag offers space for everything you need for the range and for all types of hunting.

- Fully padded rifle case with brushed inner tricot,
- Robust, water-repellent and UV-resistant Cordura outer fabric, military-grade eyelets,
- Main compartment sized for transport with silencer fitted,
- Heavy-duty YKK zips that last. Accessory pockets and main compartment can be locked individually,
- External silencer pocket,
- Large pocket with space for documents, magazines and ammunition. Inner mesh pocket for secure retention, e.g. of magazines,
- Leather details and Walther embroidery.

## **4 Walther Heat Protection Sleeve**

The ideal companion for the range and shooting cinema: the Walther heat protection sleeve allows safe removal and transport of the silencer, even when hot.

- Heat-resistant aramid fibre inlay for effective thermal insulation,
- Silencer can be unscrewed while hot and stowed immediately,
- Robustes Cordura outer material,
- Walther-embroidery and attractive flag-label,
- Drawstring with cord lock.

## **5 RS 3 Bipod**

Pure practicality: every RS 3 Pro variant features a magnetic interface for the Walther bipod or compatible shooting sticks with Spartan system interface.

- Magnetic socket for secure retention,
- Spring-loaded legs for one-handed adjustment of height,
- Legs individually adjustable to different locking heights,
- High-strength aerospace aluminium and optimized material mix for the toughest hunting use,
- Exceptionally light at just 236 grams.



2

1

3

4

5



# RS3

Short - Safe - Silent



We reserve the right to make colour and design changes and technical improvements. No responsibility is accepted for printing errors or incorrect information.  
2922649,CW.01-26.5,0,07 rev a © 2025 / Printed in Germany Carl Walther GmbH • Im Lehrer Feld 1 • 89081 Ulm • Germany